



## MAL209625152E3

<b>Hersteller-Teilenummer:</b>	MAL209625152E3
<b>Hersteller / Marke:</b>	Electro-Films (EFI) / Vishay
<b>Teil der Beschreibung:</b>	CAP ALUM 1500UF 20% 350V SNAP
<b>Datenblätter:</b>	<a href="#">1.MAL209625152E3.pdf</a> <a href="#">2.MAL209625152E3.pdf</a>
<b>RoHs Status:</b>	Bleifrei / RoHS-konform
<b>Lagerzustand:</b>	New original, Stock Available.
<b>Liefern von:</b>	Hong Kong
<b>Versandweg:</b>	DHL/Fedex/TNT/UPS/EMS

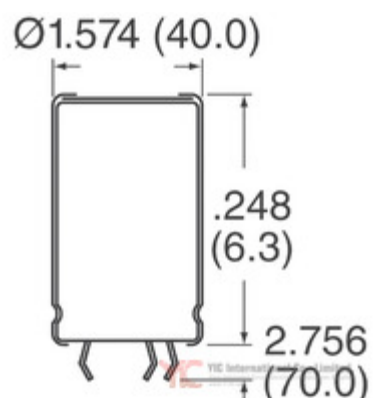

Image may be representation. See specs for product details.

### Spezifikationen

Teilenummer	MAL209625152E3
Hersteller	Electro-Films (EFI) / Vishay
Beschreibung	CAP ALUM 1500UF 20% 350V SNAP
Kategorie	Kondensatoren > Aluminiumkondensatoren
Teilstatus	Require For Quote & Check Stock
Spannung - Nennwert	350V
Toleranz	±20%
Oberflächenmontage Land Größe	-
Größe / Dimension	1.575" Dia (40.00mm)
Serie	096 PLL-4TSI
Restwelligkeit bei niedriger Frequenz	6.2A @ 100Hz
Bewertungen	-
Polarisation	Polar
Verpackung	Tape & Box (TB)
Verpackung / Gehäuse	Radial, Can - Snap-In - 4 Lead
Betriebstemperatur	-40°C ~ 85°C
Befestigungsart	Through Hole
Feuchtigkeitsempfindlichkeitsniveau (MSL)	1 (Unlimited)
Hersteller Standard Vorlaufzeit	11 Weeks
Lebensdauer @ Temp.	5000 Hrs @ 85°C
Leiter-Abstand	0.886" (22.50mm)
Bleifreier Status / RoHS-Status	Lead free / RoHS Compliant
Scheinwiderstand	49 mOhms
Höhe - eingesteckt (max)	2.756" (70.00mm)
ESR (Equivalent Series Resistance)	141 mOhm @ 100Hz
detaillierte Beschreibung	1500µF 350V Aluminum Electrolytic Capacitors Radial,
Kapazität	1500µF
Anwendungen	General Purpose

MAL209625152E3 Electronic Components ist ein 100% neues Original von YIC Distributor, MAL209625152E3-Datenblätter durchsuchen, PDF, Inventar bei Y-IC.com Online, MAL209625152E3 Electro-Films (EFI) / Vishay mit Garantie und Vertrauen bestellen. Versand per DHL / FedEx / TNT / UPS Express. Unterstützung der Zahlung mit telegrafischer Überweisung (T / T) oder PayPal.  
RFQ MAL209625152E3 E-Mail: Info@Y-IC.com

### Sie können auch interessiert

sein:

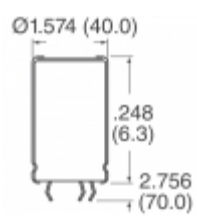

**MAL209625182E3**  
Electro-Films (EFI) / Vishay  
CAP ALUM 1800UF 20% 350V  
SNAP

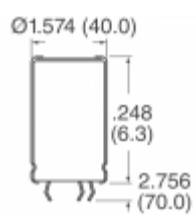

**MAL209625152E3**  
Vishay BC Components  
CAP ALUM 1500UF 20% 350V  
SNAP

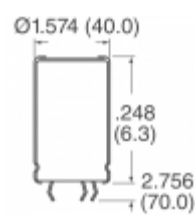

**MAL209625222E3**  
Electro-Films (EFI) / Vishay  
CAP ALUM 2200UF 20% 350V  
SNAP

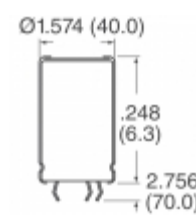

**MAL209625222E3**  
Vishay BC Components  
CAP ALUM 2200UF 20% 350V  
SNAP

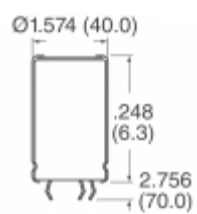

**MAL209625182E3**  
Vishay BC Components  
CAP ALUM 1800UF 20% 350V  
SNAP

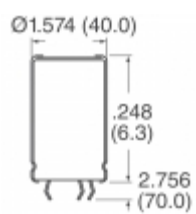

**MAL209625122E3**  
Vishay BC Components  
CAP ALUM 1200UF 20% 350V  
SNAP

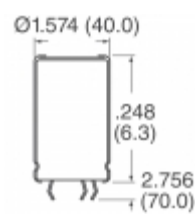

**MAL209625122E3**  
Electro-Films (EFI) / Vishay  
CAP ALUM 1200UF 20% 350V  
SNAP

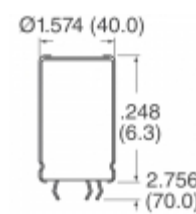

**MAL209624821E3**  
Vishay BC Components  
CAP ALUM 820UF 20% 420V  
SNAP

### Verwandtes Hot-Keyword

Mehr

MAL209625152E3 Electro-Films (EFI) / Vishay	MAL209625152E3-Datenblätter	MAL209625152E3 PDF	Electro-Films (EFI) / Vishay
MAL209625152E3 Electronic	MAL209625152E3-Komponenten	MAL209625152E3-Bild	MAL209625152E3
MAL209625152E3 Preis	MAL209625152E3 Hersteller	MAL209625152E3 Bild	MAL209625152E3-Teil
MAL209625152E3 Neu	MAL209625152E3 Original	MAL209625152E3 garantiert	MAL209625152E3 Inventar
		MAL209625152E3 RFQ	MAL209625152E3 Online bestellen

Contact us: [Info@Y-IC.com](mailto:Info@Y-IC.com)

HINZUFÜGEN: Einheit A5-B5 Nr.509, 5 / F Sing Win Fabrikgebäude, 15-17 Shing Yip St, Kwun Tong, Kowloon, HongKong.

Copyright © 2019 YIC International Co., Limited