



MAL209675821E3

Hersteller-Teilenummer:	MAL209675821E3
Hersteller / Marke:	Electro-Films (EFI) / Vishay
Teil der Beschreibung:	CAP ALUM 820UF 20% 350V SNAP
Datenblätter:	1.MAL209675821E3.pdf 2.MAL209675821E3.pdf
RoHS Status:	Bleifrei / RoHS-konform
Lagerzustand:	New original, Stock Available.
Liefern von:	Hong Kong
Versandweg:	DHL/Fedex/TNT/UPS/EMS

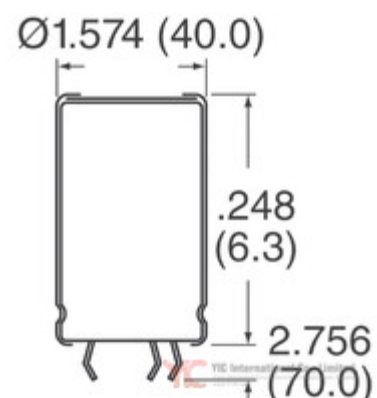

Image may be representation.
See specs for product details.

Spezifikationen

Teilenummer	MAL209675821E3
Hersteller	Electro-Films (EFI) / Vishay
Beschreibung	CAP ALUM 820UF 20% 350V SNAP
Kategorie	Kondensatoren > Aluminiumkondensatoren
Teilstatus	Require For Quote & Check Stock
Spannung - Nennwert	350V
Toleranz	±20%
Oberflächenmontage Land Größe	-
Größe / Dimension	1.575" Dia (40.00mm)
Serie	096 PLL-4T5I
Restwelligkeit bei niedriger Frequenz	3.8A @ 100Hz
Bewertungen	-
Polarisation	Polar
Verpackung	Tape & Box (TB)
Verpackung / Gehäuse	Radial, Can - 5 Lead
Betriebstemperatur	-40°C ~ 85°C
Befestigungsart	Through Hole
Feuchtigkeitsempfindlichkeitsniveau (MSL)	1 (Unlimited)
Hersteller Standard Vorlaufzeit	21 Weeks
Lebensdauer @ Temp.	5000 Hrs @ 85°C
Leiter-Abstand	0.787" (20.00mm)
Bleifreier Status / RoHS-Status	Lead free / RoHS Compliant
Scheinwiderstand	90 mOhms
Höhe - eingesteckt (max)	1.772" (45.00mm)
ESR (Equivalent Series Resistance)	128 mOhm @ 100Hz
detaillierte Beschreibung	820µF 350V Aluminum Electrolytic Capacitors Radial,
Kapazität	820µF
Anwendungen	General Purpose

MAL209675821E3 Electronic Components ist ein 100% neues Original von YIC Distributor, MAL209675821E3-Datenblätter durchsuchen, PDF, Inventar bei Y-IC.com Online, MAL209675821E3 Electro-Films (EFI) / Vishay mit Garantie und Vertrauen bestellen. Versand per DHL / FedEx / TNT / UPS Express. Unterstützung der Zahlung mit telegrafischer Überweisung (T / T) oder PayPal.
RFQ MAL209675821E3 E-Mail: Info@Y-IC.com

Sie können auch interessiert

sein:

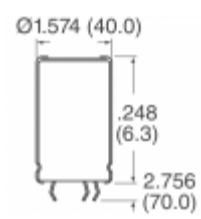

MAL209676102E3
Electro-Films (EFI) / Vishay
CAP ALUM 1000UF 20% 400V
SNAP

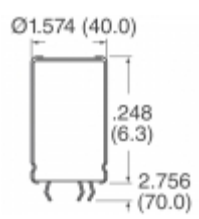

MAL209675182E3
Vishay BC Components
CAP ALUM 1800UF 20% 350V
SNAP

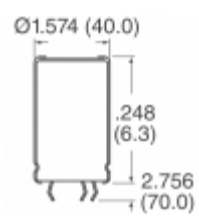

MAL209676122E3
Electro-Films (EFI) / Vishay
CAP ALUM 1200UF 20% 400V
SNAP

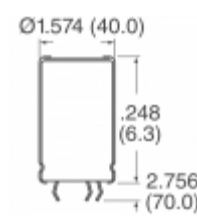

MAL209675222E3
Electro-Films (EFI) / Vishay
CAP ALUM 2200UF 20% 350V
SNAP

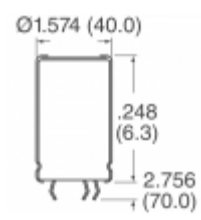

MAL209676152E3
Vishay BC Components
CAP ALUM 1500UF 20% 400V
SNAP

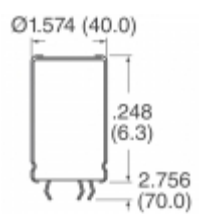

MAL209675222E3
Vishay BC Components
CAP ALUM 2200UF 20% 350V
SNAP

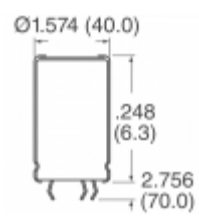

MAL209675182E3
Electro-Films (EFI) / Vishay
CAP ALUM 1800UF 20% 350V
SNAP

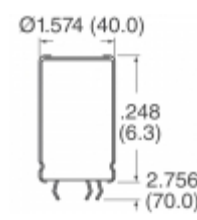

MAL209676102E3
Vishay BC Components
CAP ALUM 1000UF 20% 400V
SNAP

Verwandtes Hot-Keyword

Mehr

MAL209675821E3 Electro-Films (EFI) / Vishay	MAL209675821E3-Datenblatt	MAL209675821E3-Datenblätter	MAL209675821E3 PDF	Electro-Films (EFI) / Vishay MAL209675821E3
MAL209675821E3 Electronic	MAL209675821E3-Komponenten	MAL209675821E3-Verteiler	MAL209675821E3-Bild	MAL209675821E3-Teil
MAL209675821E3 Preis	MAL209675821E3 Hersteller	MAL209675821E3 Bild	MAL209675821E3 Aktie	MAL209675821E3 Inventar
MAL209675821E3 Neu	MAL209675821E3 Original	MAL209675821E3 garantiert	MAL209675821E3 RFQ	MAL209675821E3 Online bestellen

Contact us: Info@Y-IC.com

HINZUFÜGEN: Einheit A5-B5 Nr.509, 5 / F Sing Win Fabrikgebäude, 15-17 Shing Yip St, Kwun Tong, Kowloon, HongKong.

Copyright © 2019 YIC International Co., Limited