



MAL209669391E3

Hersteller-Teilenummer:	MAL209669391E3
Hersteller / Marke:	Electro-Films (EFI) / Vishay
Teil der Beschreibung:	CAP ALUM 390UF 20% 500V SNAP
Datenblätter:	1.MAL209669391E3.pdf 2.MAL209669391E3.pdf
RoHs Status:	Bleifrei / RoHS-konform
Lagerzustand:	New original, Stock Available.
Liefern von:	Hong Kong
Versandweg:	DHL/Fedex/TNT/UPS/EMS

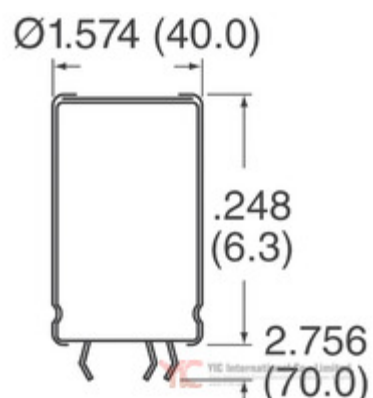

Image may be representation. See specs for product details.

Spezifikationen

Teilenummer	MAL209669391E3
Hersteller	Electro-Films (EFI) / Vishay
Beschreibung	CAP ALUM 390UF 20% 500V SNAP
Kategorie	Kondensatoren > Aluminiumkondensatoren
Teilstatus	Require For Quote & Check Stock
Spannung - Nennwert	500V
Toleranz	±20%
Oberflächenmontage Land Größe	-
Größe / Dimension	1.378" Dia (35.00mm)
Serie	096 PLL-4TSI
Restwelligkeit bei niedriger Frequenz	2.9A @ 100Hz
Bewertungen	-
Polarisation	Polar
Verpackung	Tape & Box (TB)
Verpackung / Gehäuse	Radial, Can - 4 Lead
Betriebstemperatur	-40°C ~ 85°C
Befestigungsart	Through Hole
Feuchtigkeitsempfindlichkeitsniveau (MSL)	1 (Unlimited)
Hersteller Standard Vorlaufzeit	49 Weeks
Lebensdauer @ Temp.	5000 Hrs @ 85°C
Leiter-Abstand	-
Bleifreier Status / RoHS-Status	Lead free / RoHS Compliant
Scheinwiderstand	421 mOhms
Höhe - eingesteckt (max)	2.559" (65.00mm)
ESR (Equivalent Series Resistance)	246 mOhm @ 100Hz
detaillierte Beschreibung	390µF 500V Aluminum Electrolytic Capacitors Radial,
Kapazität	390µF
Anwendungen	General Purpose

MAL209669391E3 Electronic Components ist ein 100% neues Original von YIC Distributor, MAL209669391E3-Datenblätter durchsuchen, PDF, Inventar bei Y-IC.com Online, MAL209669391E3 Electro-Films (EFI) / Vishay mit Garantie und Vertrauen bestellen. Versand per DHL / FedEx / TNT / UPS Express. Unterstützung der Zahlung mit telegrafischer Überweisung (T / T) oder PayPal.
RFQ MAL209669391E3 E-Mail: Info@Y-IC.com

Sie können auch interessiert

sein:

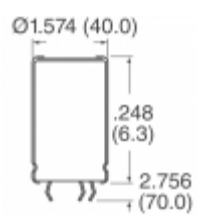

MAL2096681E3
Electro-Films (EFI) / Vishay
CAP ALUM 680UF 20% 385V
SNAP

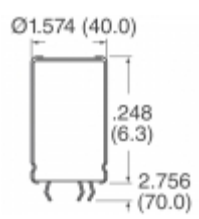

MAL209669561E3
Vishay BC Components
CAP ALUM 560UF 20% 500V
SNAP

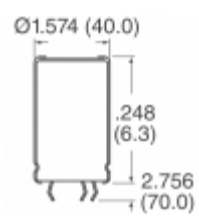

MAL20966881E3
Vishay BC Components
CAP ALUM 680UF 20% 385V
SNAP

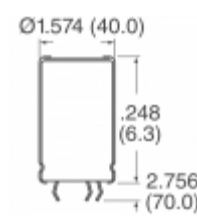

MAL209669561E3
Electro-Films (EFI) / Vishay
CAP ALUM 560UF 20% 500V
SNAP

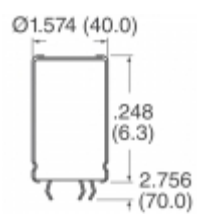

MAL209669681E3
Vishay BC Components
CAP ALUM 680UF 20% 500V
SNAP

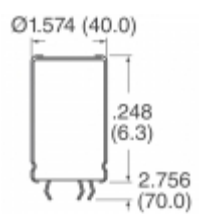

MAL209668821E3
Vishay BC Components
CAP ALUM 820UF 20% 385V
SNAP

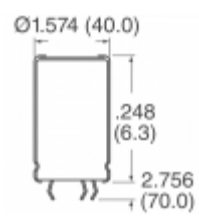

MAL209669471E3
Vishay BC Components
CAP ALUM 470UF 20% 500V
SNAP

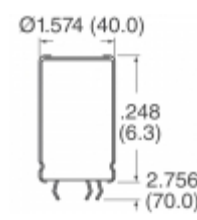

MAL209669391E3
Vishay BC Components
CAP ALUM 390UF 20% 500V
SNAP

Verwandtes Hot-Keyword

Mehr

MAL209669391E3 Electro-Films (EFI) / Vishay	MAL209669391E3 Datenblatt	MAL209669391E3-Datenblätter	MAL209669391E3 PDF	Electro-Films (EFI) / Vishay MAL209669391E3
MAL209669391E3 Electronic	MAL209669391E3-Komponenten	MAL209669391E3-Verteiler	MAL209669391E3-Bild	MAL209669391E3-Teil
MAL209669391E3 Preis	MAL209669391E3 Hersteller	MAL209669391E3 Bild	MAL209669391E3 Aktie	MAL209669391E3 Inventar
MAL209669391E3 Neu	MAL209669391E3 Original	MAL209669391E3 garantiert	MAL209669391E3 RFQ	MAL209669391E3 Online bestellen

Contact us: Info@Y-IC.com

HINZUFÜGEN: Einheit A5-B5 Nr.509, 5 / F Sing Win Fabrikgebäude, 15-17 Shing Yip St, Kwun Tong, Kowloon, HongKong.

Copyright © 2019 YIC International Co., Limited