

## DETAILS

<b>Product Number</b>	CP12689_TINA2-O
<b>Family</b>	Tina
<b>Type</b>	Assembly
<b>Color</b>	black
<b>Diameter</b>	16,1 mm
<b>Height</b>	9,5 mm
<b>Style</b>	round
<b>Optic Material</b>	PMMA
<b>Holder Material</b>	
<b>Fastening</b>	glue
<b>Status</b>	production ready
<b>ROHS Compliant</b>	Yes
<b>Date Updated</b>	5/06/2012



## OPTICAL PROPERTIES

LED	Viewing	Light	Efficiency	cd/lm	Connector
	Angle	Beam			
Oslo SSL 80	35+13 deg	Oval	86 %	3.700	-
Oslo Square EC	35+15 deg	Oval	86 %	3.800	-
Oslo SSL 150	39+12 deg	Oval	87 %	4.700	-

D

C

B

A



Isometric view  
Scale: 1:1

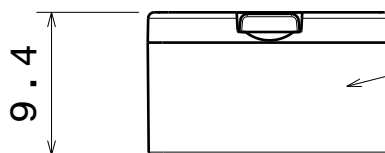
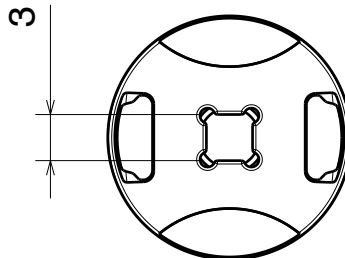

Holder

Lens

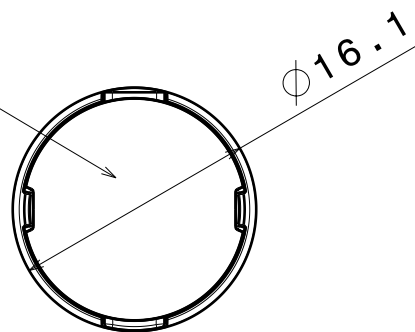

Materials:  
Lens PMMA  
Holder PC, Black

Tolerances for dimensions:  
0-20mm tolerance value  $\pm 0.1\text{mm}$   
21-45mm tolerance value  $\pm 0.2\text{mm}$   
46-90mm tolerance value  $\pm 0.3\text{mm}$   
91-100mm tolerance value  $\pm 0.4\text{mm}$   
101-mm tolerance value  $\pm 0.5\text{mm}$

This drawing is our property.  
It can't be reproduced  
or communicated without  
our written agreement.



Ledil Oy  
Salorankatu 10  
FIN 24240 SALO  
Finland

DRAWING TITLE

Datasheet Tina2 OSL Glue Assy

DRAWN BY

pv

DATE

11.04.2012

CHECKED BY

sn

DATE

12.03.2012

DESIGNED BY

pv

DATE

12.03.2012

SIZE

A4

DRAWING NUMBER

-

REV

1

SCALE

2:1

WEIGHT (g)

SHEET

1/1

A

Luminaire: LEDIL OY CP12689\_TINA2-O (SSL80) Efficiency=86%  
Lamps: 1 x Osram Oslon SSL 80° (85lm@250mA)

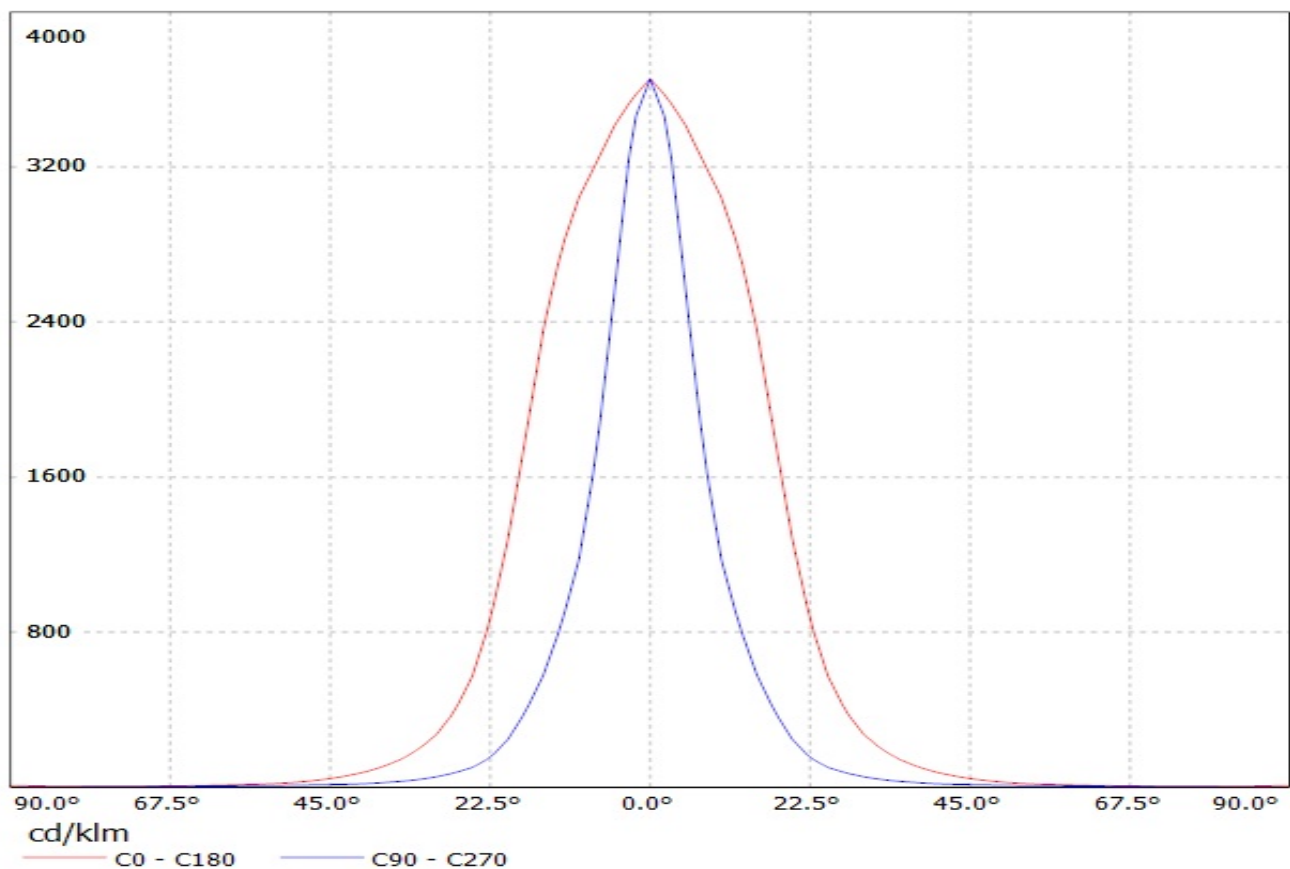

Luminaire: LEDIL OY CP12689\_TINA2-O (Osram Square EC) Efficiency=86%  
Lamps: 1 x Osram Oslon Square EC (69lm@250mA)

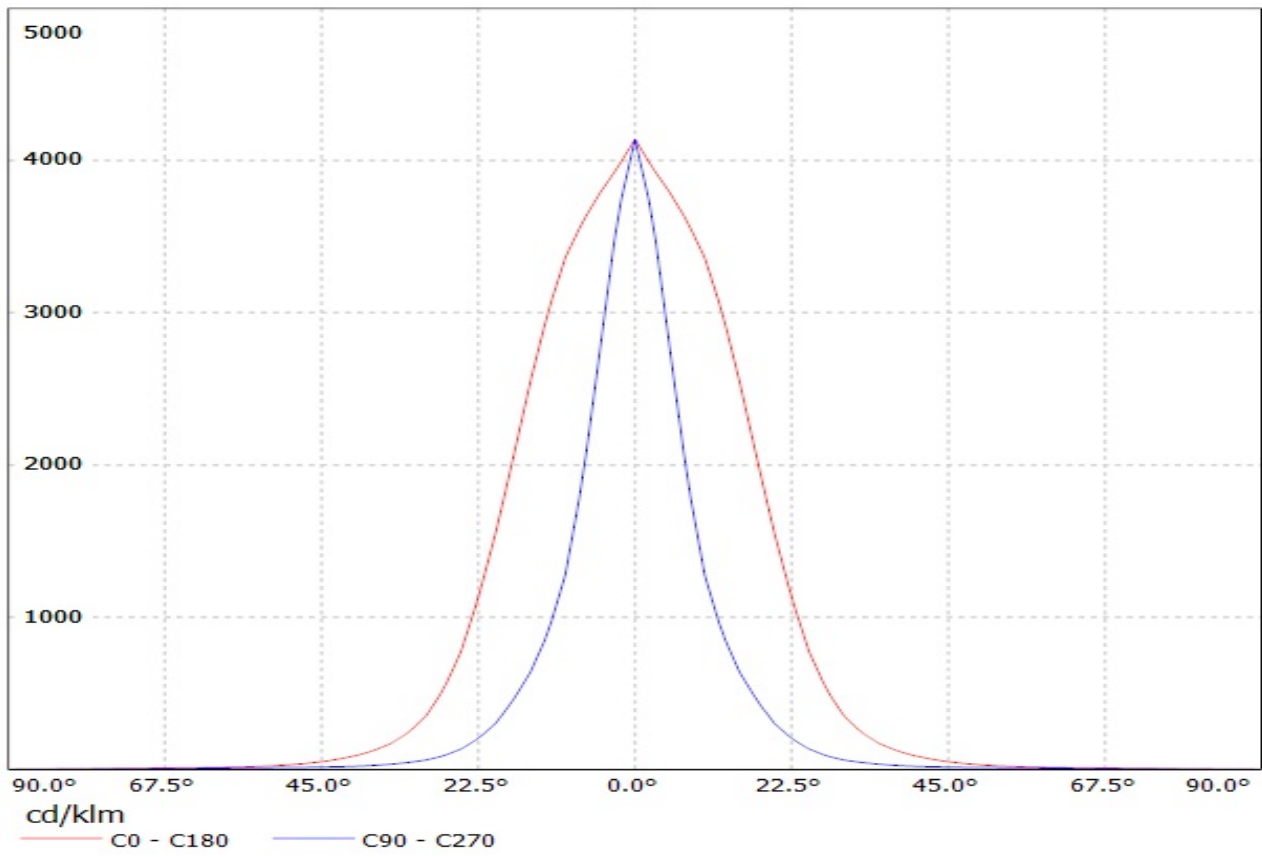

Luminaire: LEDIL OY CP12689\_TINA2-O (SSL150) Efficiency=87%  
Lamps: 1 x Osram Oslon SSL 150° (95lm@250mA)

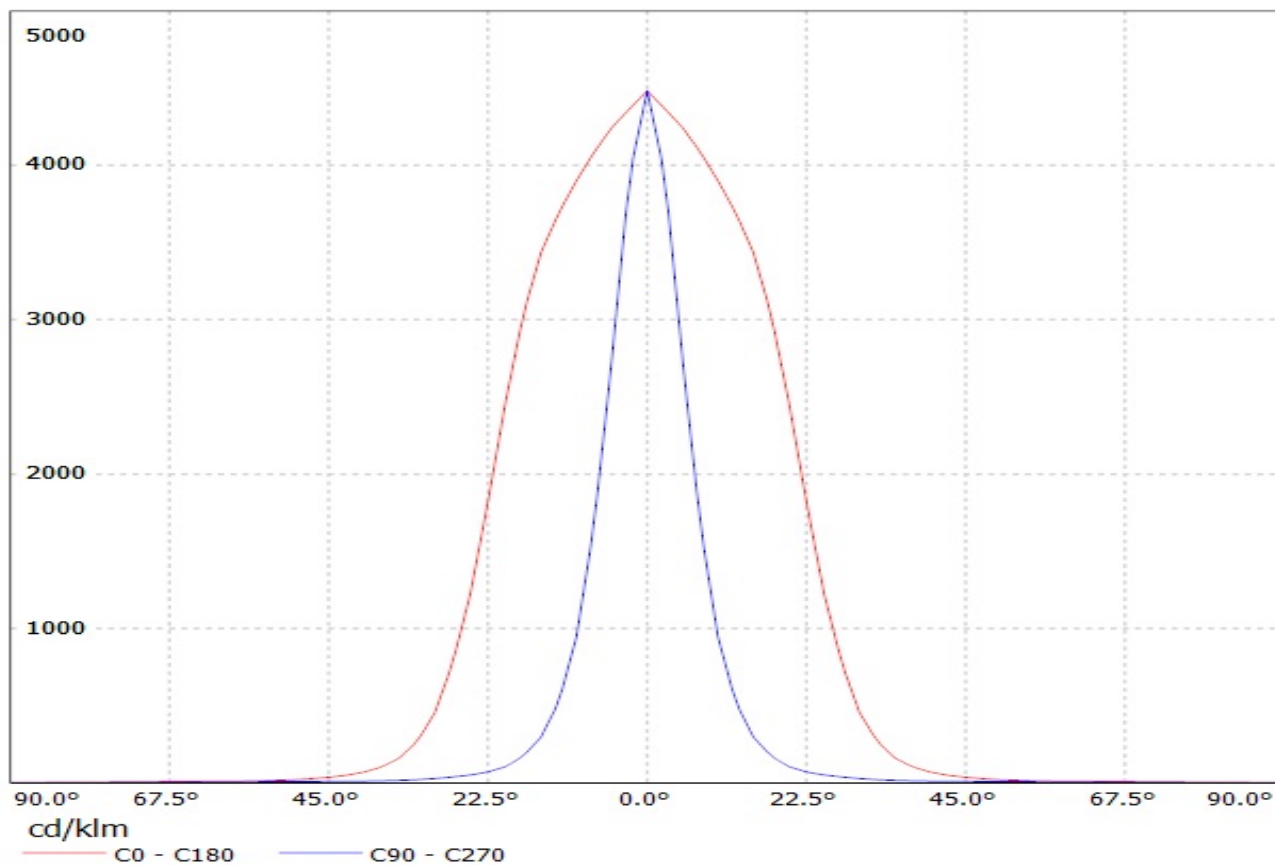

Luminaire: LEDIL OY CP12689\_TINA2-O (SSL80) Efficiency=86%  
Lamps: 1 x Osram Oslon SSL 80° (85lm@250mA)

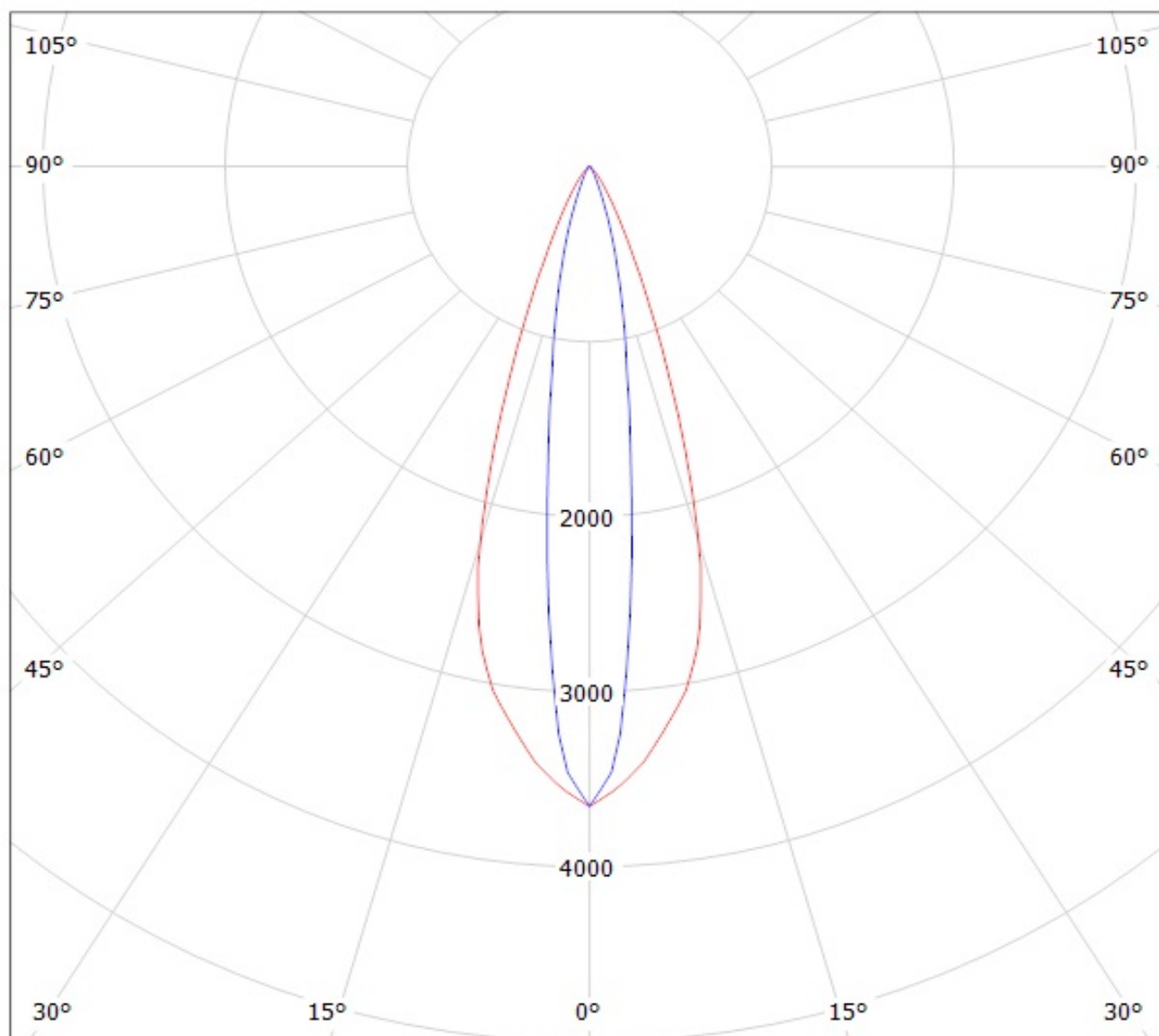

cd/klm

— C0 - C180    — C90 - C270

Luminaire: LEDIL OY CP12689\_TINA2-O (Osram Square EC) Efficiency=86%  
Lamps: 1 x Osram Oslon Square EC (69lm@250mA)

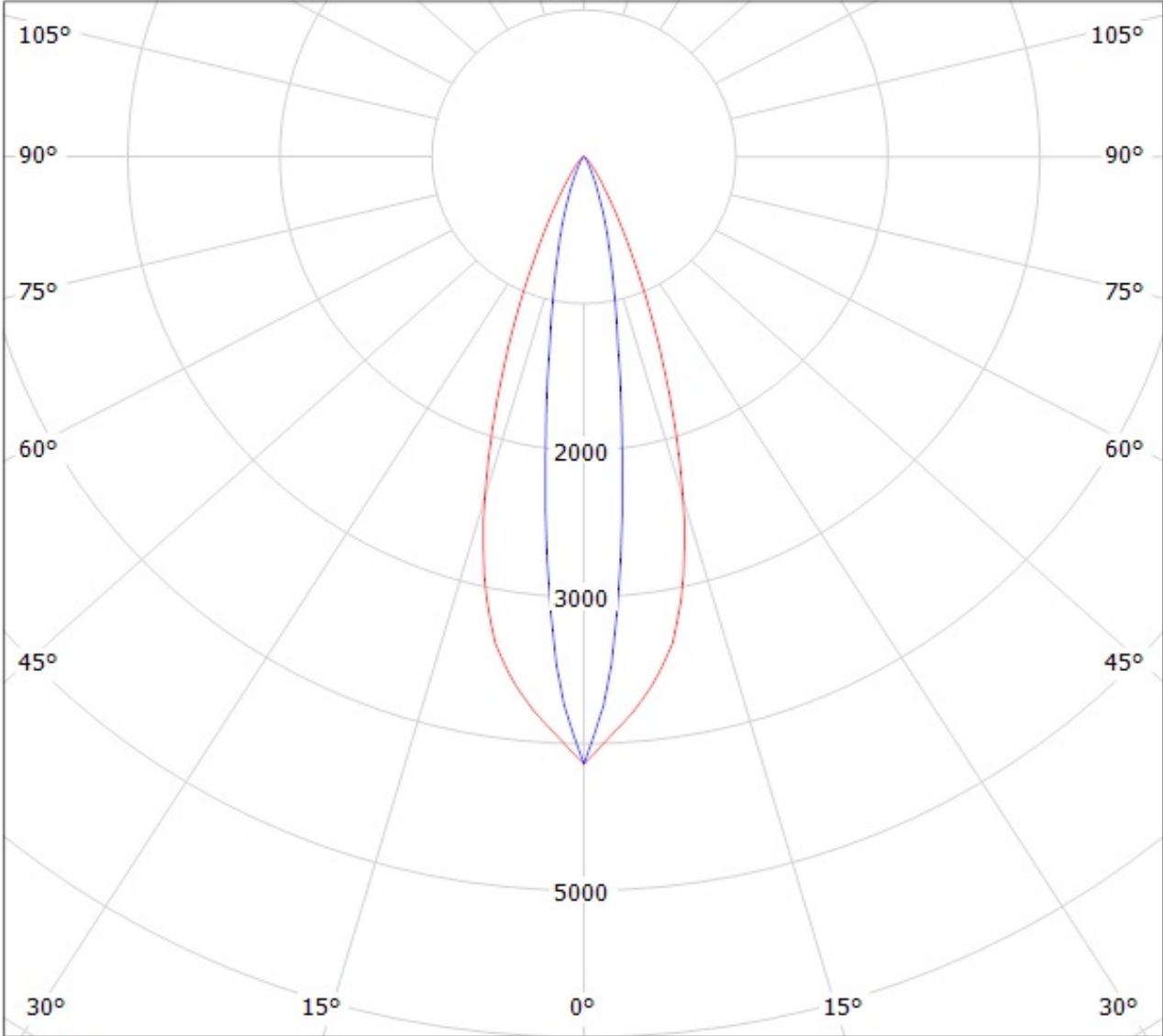

cd/klm

— C0 - C180    — C90 - C270

Luminaire: LEDIL OY CP12689\_TINA2-O (SSL150) Efficiency=87%  
Lamps: 1 x Osram Oslon SSL 150° (95lm@250mA)

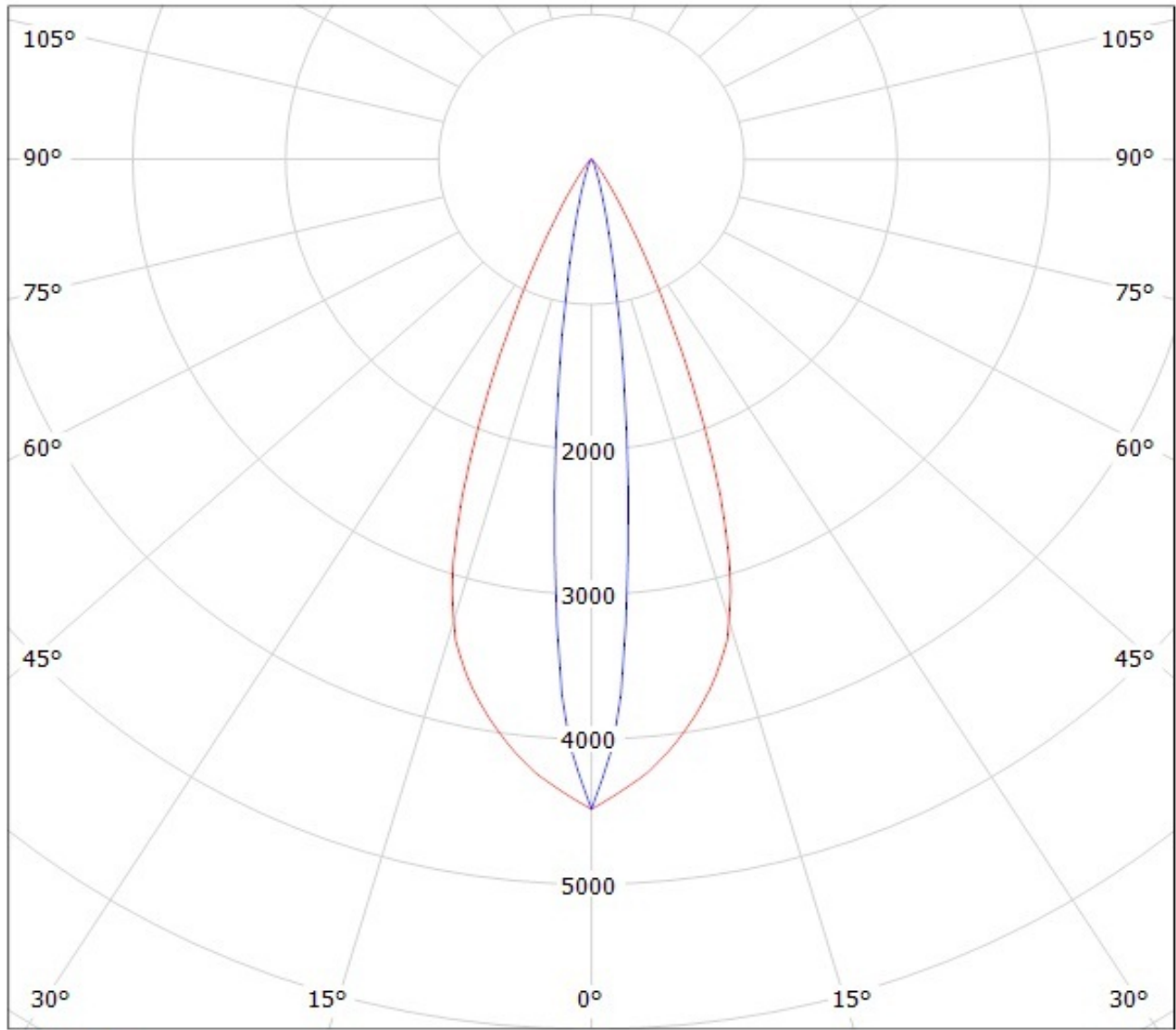

cd/klm

— C0 - C180    — C90 - C270



**NOTE: The typical divergence will be changed by different color, chip size and chip position tolerance. The typical total divergence is the full angle measured where the luminous intensity is half of the peak value.**