

SUMMARY

Wires

Low voltage 7



Image is for illustrative purpose only

Series 1P
Termination type Female solder
IP rating 50
AWG wire size 26.00 - 0.00
Cable Ø 0.00 - 0.00 mm
Status active

Download

[Request a quote](#)

[Catalog](#)

TECHNICAL DETAILS

Mechanics

Shell Style/Model PL*: Fixed receptacle, nut fixing
Keying 2 keys (alpha=40; Plug: male contacts; Receptacle: female contacts)
Housing Material PEI (Polyetherimide), gray
Variant A : Blue front nut
Weight 4.88 g

Performance

Configuration 1P.M07 : 7 Low Voltage
Insulator L: PEEK (UL 94 / V-0/1.5)
Rated Current 5 Amps

Specifications

Contact Type: Solder
Contact Dia.: 0.7 mm (0.0275in)
Bucket Dia.: 0.6 mm (0.024in)
Max. Solid Conductor: 0.14 mm² (AWG 26)
Max. Stranded Conductor: 0.14 mm² (AWG 26)
R (max): 6.5 mOhm
Test voltage (kV rms) Contact-contact: 1.05

LEMO products and services are provided "as is". LEMO makes no warranties or representations with regard to LEMO product & services or use of them, express, implied or statutory, including for accuracy, completeness, or security. The user is fully responsible for his products and applications using LEMO components.

Air clearance min.: 0.85 mm
Creepage distance min.: 0.85 mm

Others

Endurance (Shell): >2000 mating cycles
Temp (min / max): -50°C / +170°C
F ret (min): 50 N
F ret (max): 150 N
Steam sterilization: > 100 times (with potting on rear connection)

DRAWINGS

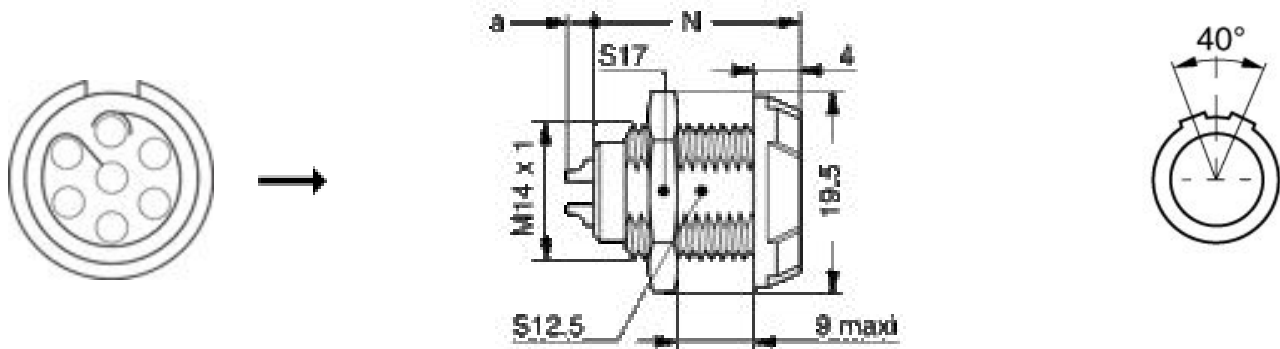

Dimensions

	A	L	N
mm.	19.5	25	20.5
in.	0,77	0,98	0,81

RECOMMENDED BY LEMO

Tools

LEMO products and services are provided "as is". LEMO makes no warranties or representations with regard to LEMO product & services or use of them, express, implied or statutory, including for accuracy, completeness, or security. The user is fully responsible for his products and applications using LEMO components.

LEMO products and services are provided "as is". LEMO makes no warranties or representations with regard to LEMO product & services or use of them, express, implied or statutory, including for accuracy, completeness, or security. The user is fully responsible for his products and applications using LEMO components.