

PART No. HWST363612S16
 for more information visit
www.hammondmfg.com
 Data subject to change without notice
 Isometric drawing Not to Scale

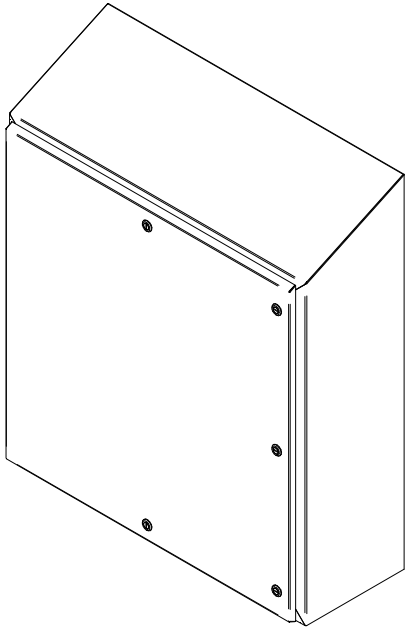

ISOMETRIC VIEW

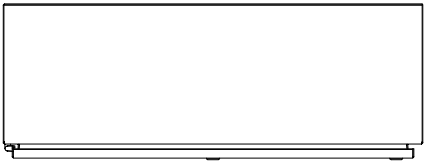

TOP VIEW

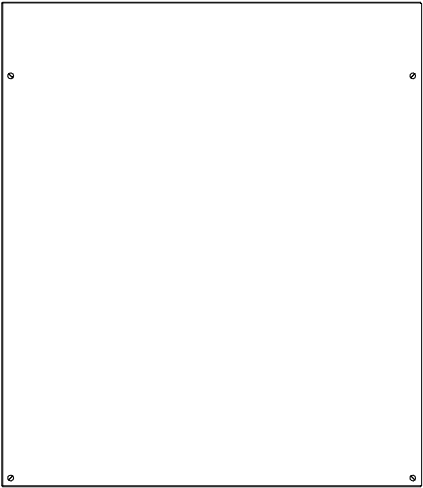

REAR VIEW

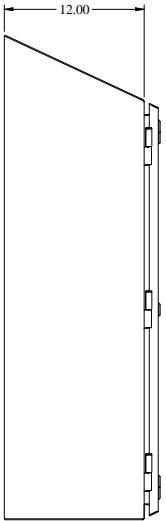

LEFT SIDE VIEW

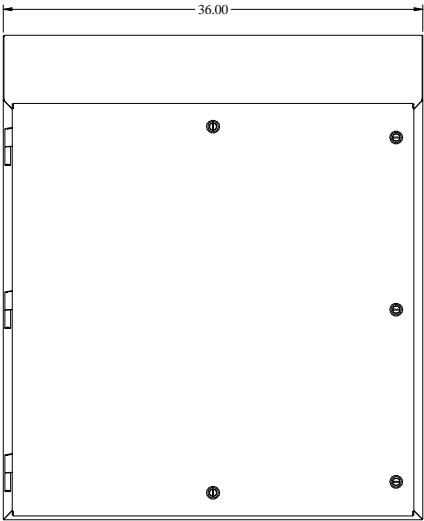

FRONT VIEW

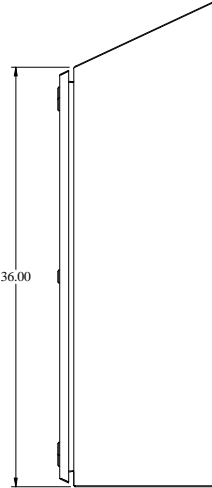

RIGHT SIDE VIEW

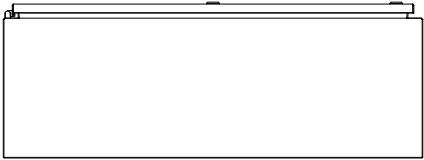

BOTTOM VIEW