

DATASHEET

Single-Channel Superluminescent Diode Source

Integrated Spectral Bench (ISB1)

**Single-SLED Light Source, 1 SLED: 1430nm, SM Fiber,
Low Degree of Polarization, Spectral Coverage: 1410nm – 1450nm,
FWHM: 40nm, CW: 1430nm, Light Output Power >10mW**

Luxmux Part Number: ASM002704



A. PRODUCT DESCRIPTION

The Single-SLED Integrated Spectral Bench (ISB1) product is a compact Superluminescent Diode (SLED) solution that employs Luxmux’s high-performance Optical Spectral Engine (OSE) module. The ISB1 is a broadband light source that operates in the near infrared range. It is a turn-key product that can easily be integrated into existing devices that require light power.

The Single-SLED ISB1 includes an integrated isolator and a proprietary driver and controller, each of which enable the light power to easily be adjusted. A Graphical User Interface (GUI) with a USB, RS232 or Ethernet connection allows for external monitoring and adjustment capabilities. The Single-SLED ISB1’s light output is powered by a standard FC/APC connector (FC/PC or SMA available upon request). The ISB1 provides under 5% DOP across the entire spectrum. This minimizes polarization sensitivity of fiber sensors, and reduces the effects of polarization dependent loss.

B. KEY FEATURES

- User-controlled box with one SLED enclosed
- Compact and user-friendly
- Centre wavelength (CW): 1430nm
- SLED can be run from 0% to 100% of maximum rating
- Output power: 10mW
- Bandwidth FWHM: 40nm
- Under 5% degree of polarization (DOP) across the spectrum
- Internally optimized for maximum coupling efficiency with smf-28e fiber
- Monolithic integration of a broadband dual stage PMF isolator (35dB)
- Includes a monitor photodiode
- Light output connector: FC/APC (optional: FC/PC or SMA)
- Multiple communication interfaces: USB, RS-232, Ethernet
- User-friendly GUI and custom API available for test automation
- Optional power meter available

C. APPLICATIONS

- Optical Component Testing
- Telecom Test Equipment
- Medical Optical Coherence Tomography
- Industrial Optical Coherence Tomography
- Fiber Optic Gyroscopes
- Metrology
- Biomedical Imaging Systems
- Optical Sensing
- White Light Interferometry
- Research and Development

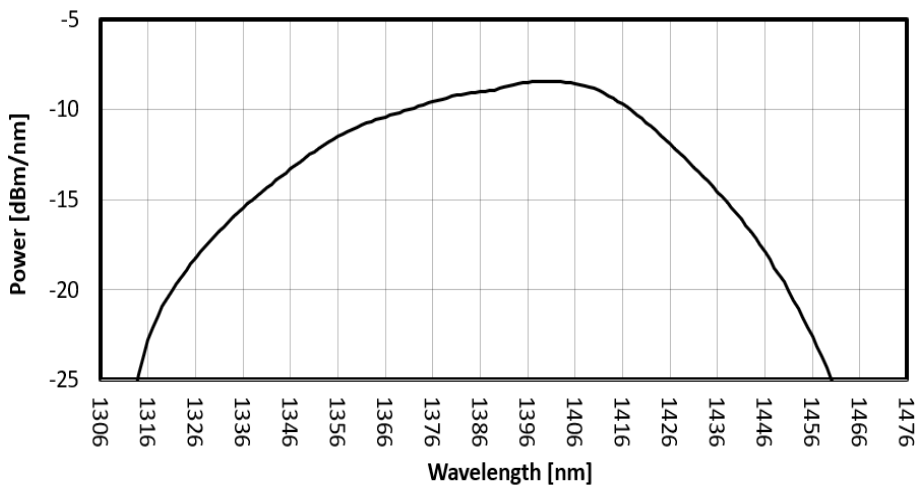

#LTC-ISB1-1430-SM-LP-1410_1450-40-1430-10_DS_2021_08_05

This document is the property of Luxmux, and contains proprietary information. Luxmux reserves the right to make product design or specification changes without notice.



Redefining Spectral Boundaries

D. ABSOLUTE MAXIMUM RATINGS

Parameter	Symbol	Condition	Minimum	Maximum	Unit
DRIVER POWER SUPPLY SPECIFICATIONS					
Input Power Supply Voltage	V _s	CW	10	14	V
Input Power Supply Current	I _s	CW	5	-	A
TEMPERATURE SPECIFICATIONS					
Case Temperature (see note 2)	T _{Case}		0	60	°C
Storage Temperature (see note 4)	T _{stg}	No condensation, Unbiased	-40	85	°C
Storage Humidity (see note 4)	RH _{stg}		5	85	%RH
Ambient Operating Temperature (See note 3)	T _{OP}		0	50	°C

Notes:

1. Please note that exceeding the Absolute Maximum Ratings above may cause device failure. Luxmux does not bear responsibility for laser power damage that is attributed to electrostatic discharge, excessive current levels, and current spikes (transients).
Any attempts to increase the laser drive current above the pre-set limits or recommended specification limits, can damage the device, and nullify the warranty period. It should be emphasized that the current limit set points cannot be exceeded.
2. For optimum performance of the Integrated Spectral Bench (ISB1), the ISB1 must be operated within the specified temperature ranges. The Single-SLED® has an internal thermoelectric cooler (TEC) to remove heat from the light source and dissipate it through the ISB1 case. It is required to provide free air circulation around the ISB1 device. It is always recommended to cool down the unit with a fan, and/or to mount the ISB1 on an appropriate heatsink, capable of dissipating up to 10W. The thermal resistance between ISB1 metal case and heatsink can be minimized by applying thermal grease, thermal glue or thermal pad between the contact surfaces. **When the Single-SLED® is used without a heatsink, maximum ambient operating temperature is 40°C.** The specification lists the operating temperature for the electrical/optical characteristics, which is the temperature of the ISB1 during the time that the specifications were measured. Variation in temperature beyond what is specified can have a significant effect on the optical characteristics, like changes in wavelength or drop in output power.
3. Storage temperature and relative humidity should be chosen so the dew point of the humid air around the package is below the storage temperature of the package, to avoid condensation inside the ISB1 enclosure.



Redefining Spectral Boundaries

E. OPTICAL AND ELECTRICAL SPECIFICATIONS (see note 5)

Parameter	Symbol	Condition	Minimum	Typical	Maximum	Unit
DRIVER POWER SUPPLY SPECIFICATIONS						
Input Power Supply Voltage	V_S	CW	10	12	14	V
Input Power Supply Current	I_S	CW	5	-	-	A
Input Power Supply Voltage Ripple and Noise	γ	CW	-	-	200	mVpp
OPTICAL SPECIFICATIONS						
Center Wavelength (see note 6)	CWL	CW $T_{OP} = 25^\circ\text{C}$ $T_{TEC} = 21^\circ\text{C}$	1420	1430	1440	nm
SM Fiber Coupled Power (see note 7)	P	CW $T_{OP} = 25^\circ\text{C}$ $T_{TEC} = 21^\circ\text{C}$ I_{OP}	10	-	-	mW
Bandwidth FWHM (see note 8)	B_{FWHM}	CW $T_{OP} = 25^\circ\text{C}$ $T_{TEC} = 21^\circ\text{C}$ I_{OP}	40	45	-	nm
Bandwidth @ -10dB (see note 5)	$B_{@10dB}$	CW $T_{OP} = 25^\circ\text{C}$ $T_{TEC} = 21^\circ\text{C}$ I_{OP}	-	90	-	nm
Spectrum Ripple (see note 9)	R	CW $T_{OP} = 25^\circ\text{C}$ $T_{TEC} = 21^\circ\text{C}$	< 0.15	< 0.30	< 0.45	dB
Spectral Coverage	SC	CW $T_{OSE2} = 25^\circ\text{C}$ $T_{TEC} = 21^\circ\text{C}$ I_{OP}	-	1410 – 1450	-	nm
Degree of Polarization (see note 10)	DOP	CW $T_{OP} = 25^\circ\text{C}$ $T_{TEC} = 21^\circ\text{C}$ I_{OP}	-	-	5	%
RIN	RIN		-	< -130	-	dB/Hz
Power Stability (After 1h warm up)	P_{STAB}	@ $25^\circ\text{C} \pm 1^\circ\text{C}$	-	< 0.1	-	dB
Warmup Time	W		15	30	60	Min.
CONSTANT CURRENT MODE						
Operating Current	I_{OP}	CW $T_{OP} = 25^\circ\text{C}$ $T_{TEC} = 21^\circ\text{C}$	-	-	350	mA
Current Setting Resolution	R_{IOP_SET}		-	-	0.1	mA
SLED Current Reading Resolution	R_{IOP_READ}		-	0.1	-	mA

#LTC-ISB1-1430-SM-LP-1410_1450-40-1430-10_DS_2021_08_05

This document is the property of Luxmux, and contains proprietary information. Luxmux reserves the right to make product design or specification changes without notice.



Redefining Spectral Boundaries

Parameter	Symbol	Condition	Minimum	Typical	Maximum	Unit
MODULATION MODE						
Waveform			-	Square	-	
Modulation Frequency Range	f_{mod}		0.016	-	1000	Hz
Duty Cycle	D		10	50	90	%
INTERNAL MONITOR DIODE						
Monitor Diode Current Reading	I_{mon}		-	-	500	μ A
Monitor Diode Current Reading Resolution	$RES_{I_{mon}}$		-	7.6	-	nA
LIGHT OUTPUT CONNECTOR						
Type of Fiber Connector			-	FC/PC, FC/APC, SMA	-	
SLED TEC SPECIFICATIONS						
SLED TEC Temperature Setpoint	T_{SLED_SET}		0	-	40	$^{\circ}$ C
SLED TEC Temperature Setpoint Resolution	R_{TSLED_SET}		-	0.1	-	$^{\circ}$ C
SLED TEC Temperature Reading	T_{SLED_READ}		-40	-	100	$^{\circ}$ C
SLED TEC Temperature Reading Resolution	R_{TSLED_READ}		-	0.1	-	$^{\circ}$ C
TEMPERATURE SPECIFICATIONS						
Heatsink Temperature Reading Range	T_{HS}		-40	-	100	$^{\circ}$ C
Heatsink Temperature Reading Resolution	R_{THS}		-	0.1	-	$^{\circ}$ C
POWER METER						
Spectral Response Range	λ_{PM}		900	-	1870	nm
Photosensitive Area	A_{PM}		-	$\Phi 1$	-	mm
Power Meter Current Reading	P_{PM}		50	-	-	μ A
Peak Sensitivity Wavelength	λ_p		-	1750	-	nm
Photo Sensitivity	S	$\lambda = \lambda_p$	0.9	1.1	-	A/W
Typical Dark Current	I_D		-	1	10	nA
Detectivity	D^*	$\lambda = \lambda_p$	2×10^{12}	5.5×10^{12}	-	$cm^*Hz^{1/2}/W$
Noise Equivalent Power	NEP	$\lambda = \lambda_p$	-	1.5×10^{-14}	4×10^{-14}	$W/Hz^{1/2}$

#LTC-ISB1-1430-SM-LP-1410_1450-40-1430-10_DS_2021_08_05

This document is the property of Luxmux, and contains proprietary information. Luxmux reserves the right to make product design or specification changes without notice.



Redefining Spectral Boundaries

Parameter	Symbol	Condition	Minimum	Typical	Maximum	Unit
POWER METER TEC SPECIFICATIONS						
Power Meter TEC Temperature Setpoint	T _{PM_SET}		-20	-	40	°C
Power Meter TEC Temperature Setpoint Resolution	R _{TPM_SET}		-	0.1	-	°C
Power Meter TEC Temperature Reading	T _{PM_READ}		-40	-	85	°C
Power Meter TEC Temperature Reading Resolution	R _{TPM_READ}		-	0.1	-	°C
Notes:						
<ol style="list-style-type: none"> 5. <i>There may be differences in typical values of output power, power stability, wavelength and bandwidth, due to coupling efficiency. These values are references and there is no guarantee that each particular ISB1 module will have EXACTLY the typical values shown on the previous chart.</i> 6. <i>Center Wavelength is defined as the center point of the 3dB bandwidth of the SLED.</i> 7. <i>The ISB1 uses a Dual Stage Isolator for back reflection protection. Isolators are used to protect a source from back reflections or signals that may occur after the isolator. Back reflections can damage a laser source or cause it to amplitude modulate, or frequency shift. In high-power applications, back reflections can cause instabilities and power spikes. Luxmux does not bear responsibility for laser power damage that is attributed to hot spots in the beam.</i> 8. <i>Single-SLED® FWHM is defined as the bandwidth from the lowest spectral dip, when the SLED is on.</i> 9. <i>Resolution of 0.1nm.</i> 10. <i>Degree of Polarization is defined as the ratio of optical powers of perpendicular polarizations, expressed in percentage (%).</i> 						

#LTC-ISB1-1430-SM-LP-1410_1450-40-1430-10_DS_2021_08_05

This document is the property of Luxmux, and contains proprietary information. Luxmux reserves the right to make product design or specification changes without notice.

F. PLOTS - Test performed at $T_{OP}=25^{\circ}C$ and $T_{TEC}=21^{\circ}C$

FIG. 1: ISB1 SPECTRUM

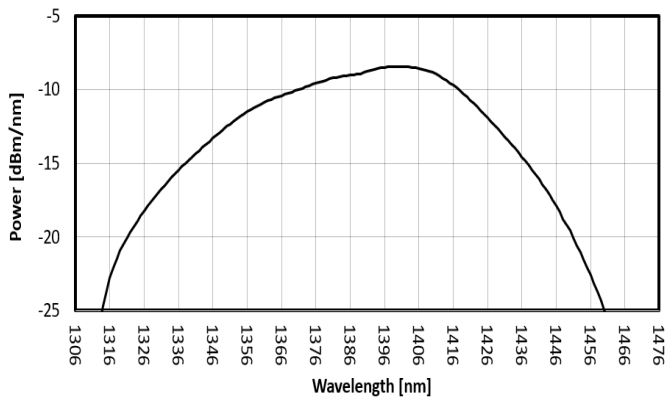

FIG. 2: SLED OUTPUT POWER VS CURRENT

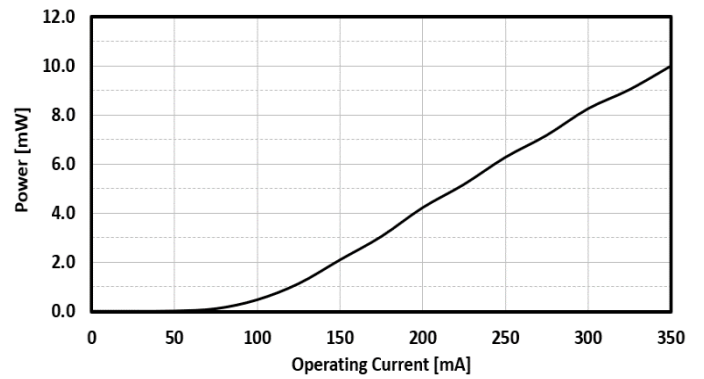

FIG. 3: ISB1 TYPICAL POWER STABILITY

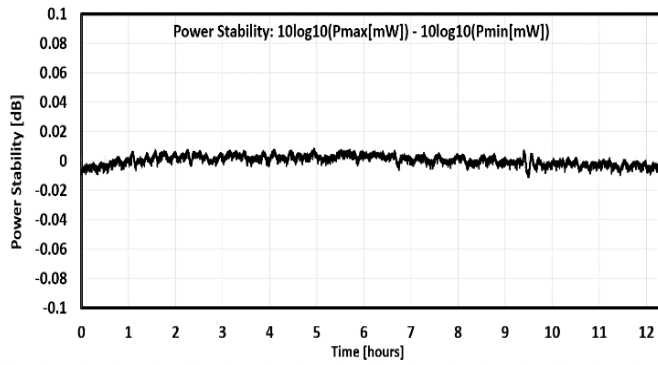

FIG. 4: WARM-UP TIME

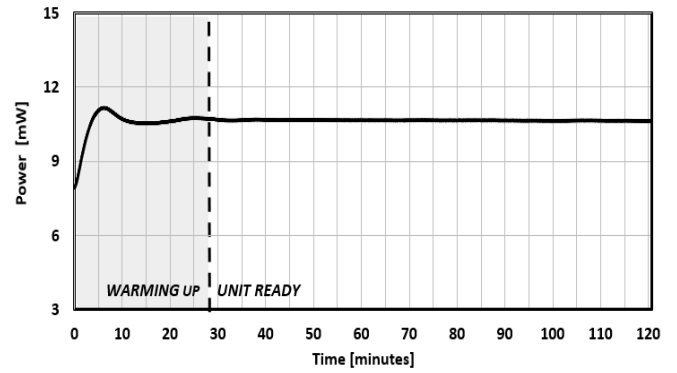
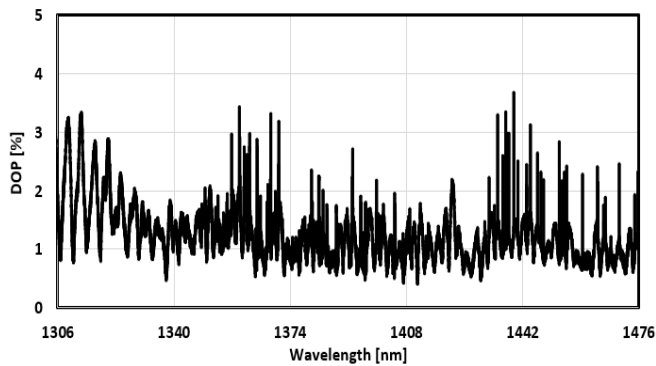
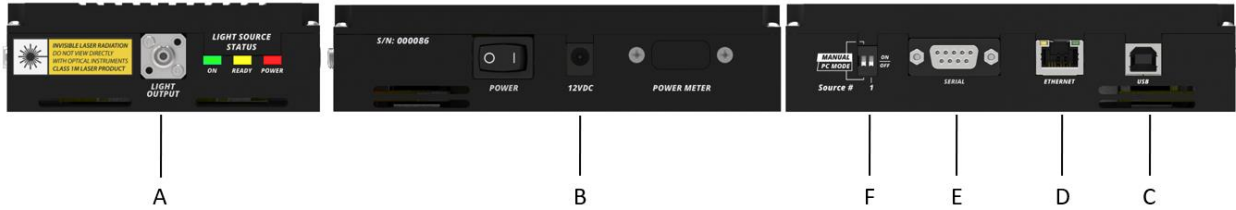

FIG. 5: DEGREE OF POLARIZATION



G. CONNECTORS



Item	Description
A	FC/APC Connector (Optional: FC/PC, SMA)
B	Power Barrel Connector Jack 2.00mm ID, 5.50mm OD, 9.5 mm Length. Center Positive $\ominus \text{---} \oplus$ Input: AC 100-240V Output: 12V 5V min
C	USB 2.0 Type B
D	RJ45 for MODBUS TCP/IP Communication
E	D-SUB 9 Positions for RS-232 Communication
F	Switches to change between PC Mode - Manual Mode and to turn SLED on when operating in Manual Mode

H. D-SUB CONNECTOR PIN OUT

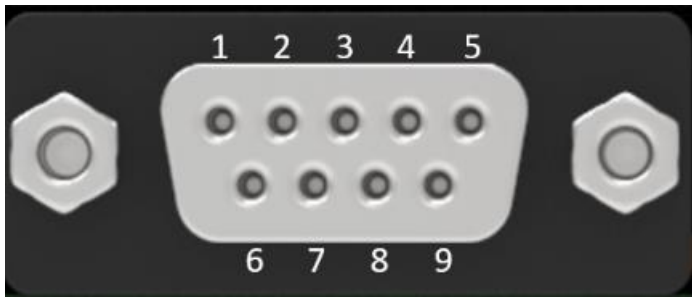

Pin #	Function RS-232
1	Not used
2	Tx
3	Rx
4	Not used
5	GND
6	Not used
7	Not used
8	Not used
9	Not used

I. MANUAL CONTROL

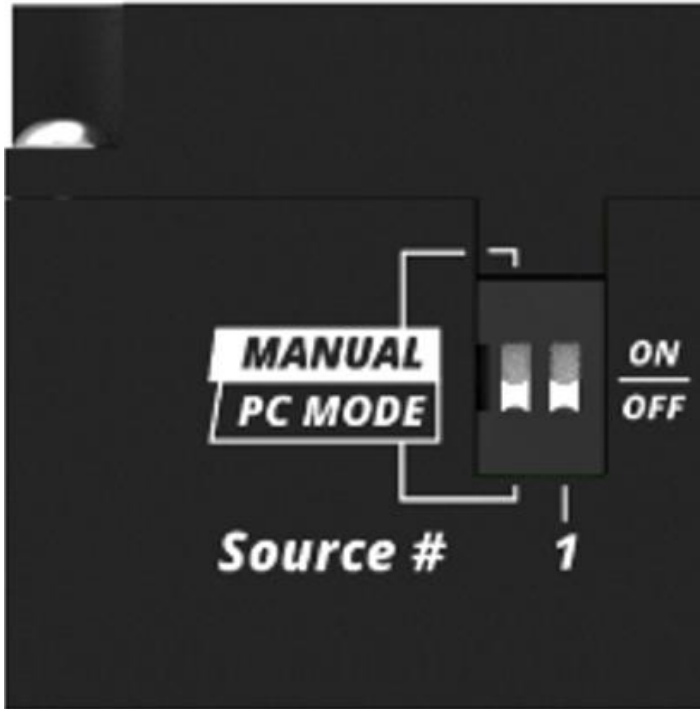

Pin #	UP	DOWN
1	Light Source in Manual Mode	Light Source in PC Mode
2	SLED ON	SLED OFF

J. OSE1 14-PIN BUTTERFLY PACKAGE PIN OUT

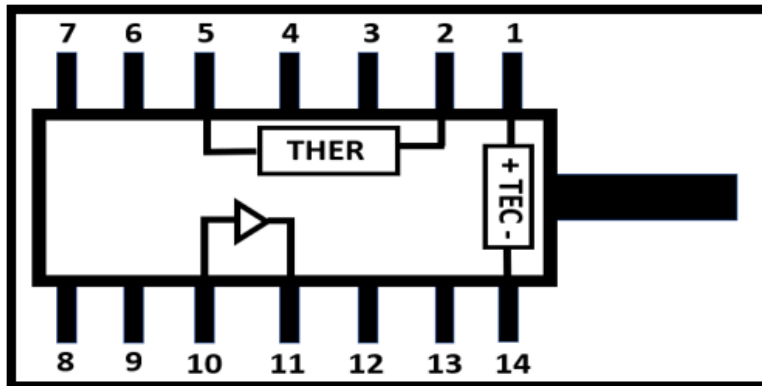

EXTERNAL PIN ASSIGNMENT			
1	TEC (+)	8	NC
2	Thermistor	9	NC
3	NC	10	SLED Anode (+)
4	NC	11	SLED Cathode (-)
5	Thermistor	12	NC
6	NC	13	Case
7	NC	14	TEC (-)

K. MECHANICAL DIAGRAM – LOW DOP ISB1

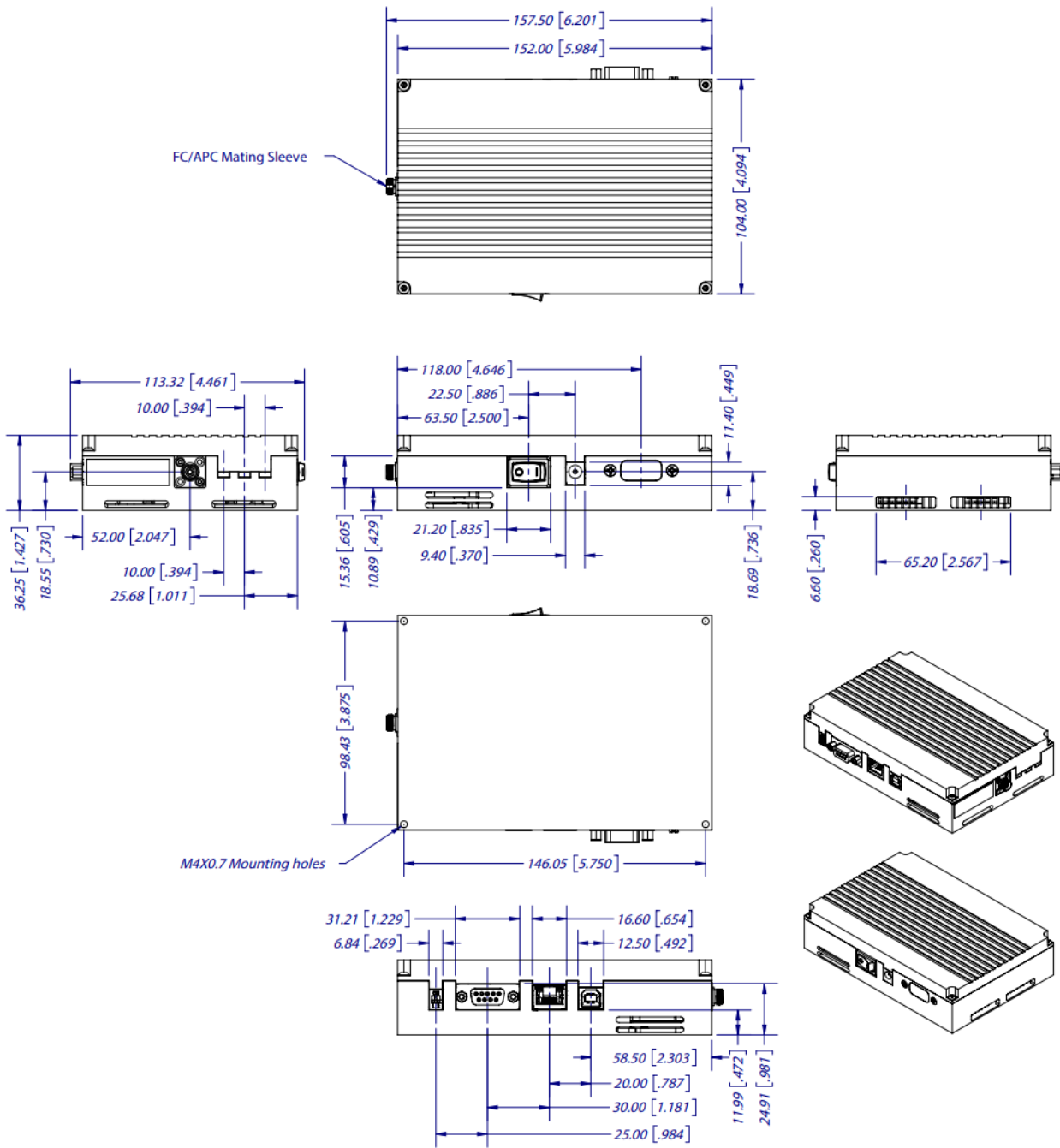

#LTC-ISB1-1430-SM-LP-1410_1450-40-1430-10_DS_2021_08_05

This document is the property of Luxmux, and contains proprietary information. Luxmux reserves the right to make product design or specification changes without notice.

L. MECHANICAL DIAGRAM – LOW DOP ISB1 WITH POWER METER

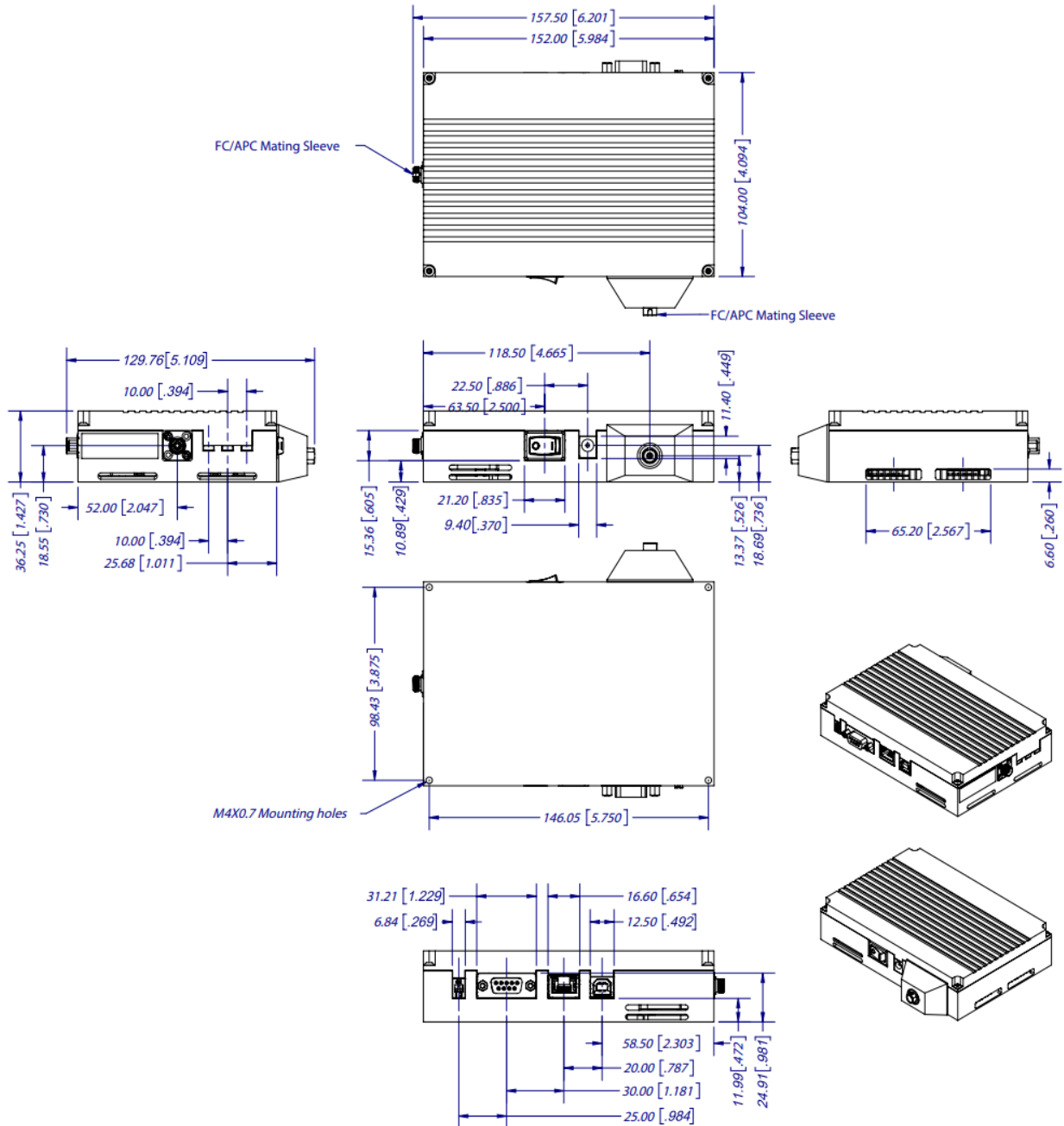

#LTC-ISB1-1430-SM-LP-1410_1450-40-1430-10_DS_2021_08_05

This document is the property of Luxmux, and contains proprietary information. Luxmux reserves the right to make product design or specification changes without notice.

M. SAFETY

All statements regarding safety of operation and technical data will only apply when the unit is operated correctly.

The driver must not be operated in environments susceptible to explosion hazards. Do not obstruct the air ventilation slots. If any parts of the driver, or electronics are broken or exposed, contact Luxmux technical support and do not attempt to operate the unit.

The ISB1 is a Class 1M laser product. It is safe for all conditions of use except when passed through magnifying optics such as microscopes and telescopes. It produces a beam that is divergent. If light is re-focused use protective eye wear.

N. APPLICATION PROTOCOL INTERFACE (API)

Luxmux's driver utilizes the MODBUS Protocol for communications. Users can find numerous detailed specifications for the protocol on the internet. MODBUS is used widely in industrial applications. The driver is designed to use this protocol over all of its communication interfaces, MODBUS – RTU is a master/slave protocol and is employed by the USB or RS232 port, and MODBUS - TCP/IP is a client/server protocol and is employed by the Ethernet Interface.

The MODBUS specification has outlined how a user can adapt the overall packet structure to suit each interface requirement. The primary section of a MODBUS packet is known as the Protocol Data Unit (PDU) and it is independent of the underlying communication interface. The PDU includes additional byte fields for the MODBUS transaction per the Application Data Unit (ADU).

A high-level overview of MODBUS Protocol can be found on the ISB1 User Manual. If users want to develop their own API, the ISB1 Register Map is available upon request. Please contact technical support: techsupport@luxmux.com.



Redefining Spectral Boundaries

O. ORDERING CODE

ORDERING CODE:		LTC	ISB1	SLEDs	FT	DOP	SC	FWHM	CW	LOP
LTC	Luxmux Technology Corporation									
ISB1	Single-sled® Integrated Spectral Bench G1									
SLEDs	SLED center wavelength, choose one of the following models: 1300nm, 1340nm, 1390nm, 1430nm, 1480nm, 1550nm, 1615nm, 1680nm									
FT	Fiber Type, choose 1: PM: Polarization Maintaining SM: Single Mode									
DOP	Degree of Polarization LP: Low Degree of Polarization HP: High Degree of Polarization									
SC	Spectral Coverage [nm]									
FWHM	Full Width Half Maximum [nm] [FWHM defined as the bandwidth from the lowest spectral dip]									
CW	Center Wavelength [nm]									
LOP	Light Output Power [mW]									

Product Code
 Available Options
 Taken From Table

Part Number	Ordering Code: LTC-ISB1-(SLED)-(FT)-(DOP)-(SC)-(FWHM)-(CW)-(LOP)	SLED [nm]	FT	SC [nm]	FWHM [nm]	CW [nm]	LOP [mW]
ASM002501	LTC-ISB1-1300-PM-HP-1270_1330-60-1300-12	1300	PM	1270-1330	60	1300	12
ASM002502	LTC-ISB1-1340-PM-HP-1310_1370-60-1340-12	1340	PM	1310-1370	60	1340	12
ASM002503	LTC-ISB1-1390-PM-HP-1360_1420-60-1390-10	1390	PM	1360-1420	60	1390	10
ASM002504	LTC-ISB1-1430-PM-HP-1410_1450-40-1430-10	1430	PM	1410-1450	40	1430	10
ASM002505	LTC-ISB1-1480-PM-HP-1455_1505-50-1480-13	1480	PM	1455-1505	50	1480	13
ASM002506	LTC-ISB1-1550-PM-HP-1515_1585-70-1550-15	1550	PM	1515-1585	70	1550	15
ASM002507	LTC-ISB1-1615-PM-HP-1585_1645-60-1615-6	1615	PM	1585-1645	60	1615	6
ASM002508	LTC-ISB1-1680-PM-HP-1655_1705-50-1680-13	1680	PM	1655-1705	50	1680	8
ASM002509	LTC-ISB1-1550-PM-HP-1500_1600-70-1550-8	1550	PM	1500-1600	70	1550	8
ASM002512	LTC-ISB1-1550-PM-HP-1532_1568-35-1550-30	1550	PM	1532-1568	35	1550	30

Part Number	Ordering Code: LTC-ISB1-(SLED)-(FT)-(DOP)-(SC)-(FWHM)-(CW)-(LOP)	SLED [nm]	FT	SC [nm]	FWHM [nm]	CW [nm]	LOP [mW]
ASM002601	LTC-ISB1-1300-SM-HP-1270_1330-60-1300-12	1300	SM	1270-1330	60	1300	12
ASM002602	LTC-ISB1-1340-SM-HP-1310_1370-60-1340-12	1340	SM	1310-1370	60	1340	12
ASM002603	LTC-ISB1-1390-SM-HP-1360_1420-60-1390-10	1390	SM	1360-1420	60	1390	10
ASM002604	LTC-ISB1-1430-SM-HP-1410_1450-40-1430-10	1430	SM	1410-1450	40	1430	10
ASM002605	LTC-ISB1-1480-SM-HP-1455_1505-50-1480-13	1480	SM	1455-1505	50	1480	13
ASM002606	LTC-ISB1-1550-SM-HP-1515_1585-70-1550-15	1550	SM	1515-1585	70	1550	15
ASM002607	LTC-ISB1-1615-SM-HP-1585_1645-60-1615-6	1615	SM	1585-1645	60	1615	6
ASM002608	LTC-ISB1-1680-SM-HP-1655_1705-50-1680-13	1680	SM	1655-1705	50	1680	8
ASM002609	LTC-ISB1-1550-SM-HP-1500_1600-70-1550-8	1550	SM	1500-1600	70	1550	8
ASM002612	LTC-ISB1-1550-SM-HP-1532_1568-35-1550-30	1550	SM	1532-1568	35	1550	30

#LTC-ISB1-1430-SM-LP-1410_1450-40-1430-10_DS_2021_08_05

This document is the property of Luxmux, and contains proprietary information. Luxmux reserves the right to make product design or specification changes without notice.



Redefining Spectral Boundaries

Part Number	Ordering Code: LTC-ISB1-(SLED)-(FT)-(DOP)-(SC)-(FWHM)-(CW)-(LOP)	SLED [nm]	FT	SC [nm]	FWHM [nm]	CW [nm]	LOP [mW]
ASM002701	LTC-ISB1-1300-SM-LP-1270_1330-60-1300-12	1300	SM	1270-1330	60	1300	12
ASM002702	LTC-ISB1-1340-SM-LP-1310_1370-60-1340-12	1340	SM	1310-1370	60	1340	12
ASM002703	LTC-ISB1-1390-SM-LP-1360_1420-60-1390-10	1390	SM	1360-1420	60	1390	10
ASM002704	LTC-ISB1-1430-SM-LP-1410_1450-40-1430-10	1430	SM	1410-1450	40	1430	10
ASM002705	LTC-ISB1-1480-SM-LP-1455_1505-50-1480-13	1480	SM	1455-1505	50	1480	13
ASM002706	LTC-ISB1-1550-SM-LP-1515_1585-70-1550-15	1550	SM	1515-1585	70	1550	15
ASM002707	LTC-ISB1-1615-SM-LP-1585_1645-60-1615-6	1615	SM	1585-1645	60	1615	6
ASM002708	LTC-ISB1-1680-SM-LP-1655_1705-50-1680-13	1680	SM	1655-1705	50	1680	8
ASM002709	LTC-ISB1-1550-SM-LP-1500_1600-70-1550-8	1550	SM	1500-1600	70	1550	8
ASM002712	LTC-ISB1-1550-SM-LP-1532_1568-35-1550-30	1550	SM	1532-1568	35	1550	30

#LTC-ISB1-1430-SM-LP-1410_1450-40-1430-10_DS_2021_08_05

This document is the property of Luxmux, and contains proprietary information. Luxmux reserves the right to make product design or specification changes without notice.

Luxmux Technology Corporation, 1030-2424 4th Street SW, Calgary, Canada, T2S 2T4
sales@luxmux.com, +1 (587) 392-6192, www.luxmux.com