

Not Insulated SOT-227 Power Module U-Series FRED Pt® Gen 4, 600 V

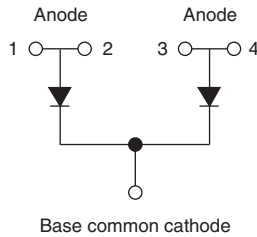

SOT-227



FEATURES

- Gen 4 FRED Pt® dices technology
- Ultrasoft reverse recovery characteristics
- Low I_{RRM} and reverse recovery charge
- Very low forward voltage drop
- Not insulated package
- 175 °C operating junction temperature
- Optimized for power conversion: welding and industrial SMPS applications
- Plug-in compatible with other SOT-227 packages
- Easy to assemble
- Direct mounting to heatsink
- Designed and qualified for industrial level
- Material categorization: for definitions of compliance please see www.vishay.com/doc?99912



DESCRIPTION

Gen 4 FRED technology, state of the art, ultra low V_F , soft switching optimized for IGBT F/W diode. The minimized conduction loss, optimized storage charge and low recovery current minimized the switching losses and reduce the over dissipation in the switching element and snubbers.

PRIMARY CHARACTERISTICS	
V_R	600 V
$I_{F(AV)}$ at $T_C = 124$ °C per module ⁽¹⁾	450 A
t_{rr}	97 ns
Type	Modules - Diode FRED Pt®
Package	SOT-227
Circuit configuration	Common cathode

Note

(1) All 4 anode terminals connected

ABSOLUTE MAXIMUM RATINGS ($T_J = 25$ °C unless otherwise specified)				
PARAMETER	SYMBOL	TEST CONDITIONS	MAX.	UNITS
Cathode to anode voltage	V_R		600	V
Continuous forward current per diode	I_F	$T_C = 133$ °C	250	A
Single pulse forward current per diode	I_{FSM}	$T_C = 25$ °C, 10 ms sine or 6 ms rectangular pulse	1170	
Maximum power dissipation per module	P_D	$T_C = 135$ °C	727	W
Operating junction and storage temperatures	T_J, T_{Stg}		-55 to +175	°C



ELECTRICAL SPECIFICATIONS PER DIODE ($T_J = 25\text{ }^\circ\text{C}$ unless otherwise specified)						
PARAMETER	SYMBOL	TEST CONDITIONS	MIN.	TYP.	MAX.	UNITS
Cathode to anode breakdown voltage	V_{BR}	$I_R = 500\text{ }\mu\text{A}$	600	-	-	V
Forward voltage, per leg	V_{FM}	$I_F = 100\text{ A}$	-	1.18	1.32	
		$I_F = 100\text{ A}, T_J = 125\text{ }^\circ\text{C}$	-	1.00	-	
		$I_F = 100\text{ A}, T_J = 175\text{ }^\circ\text{C}$	-	0.91	-	
		$I_F = 200\text{ A}$	-	1.34	1.60	
		$I_F = 200\text{ A}, T_J = 125\text{ }^\circ\text{C}$	-	1.19	-	
Reverse leakage current, per leg	I_{RM}	$V_R = V_R = 600\text{ V},$	-	0.2	150	μA
		$V_R = V_R = 600\text{ V}, T_J = 125\text{ }^\circ\text{C}$	-	169	-	mA
		$V_R = V_R = 600\text{ V}, T_J = 175\text{ }^\circ\text{C}$	-	2.1	-	
Junction capacitance, per leg	C_T	$V_R = 600\text{ V}, f = 1\text{ MHz}$	-	173	-	pF

DYNAMIC RECOVERY CHARACTERISTICS PER DIODE ($T_J = 25\text{ }^\circ\text{C}$ unless otherwise specified)							
PARAMETER	SYMBOL	TEST CONDITIONS	MIN.	TYP.	MAX.	UNITS	
Reverse recovery time, per leg	t_{rr}	$T_J = 25\text{ }^\circ\text{C}$	-	97	-	ns	
		$T_J = 125\text{ }^\circ\text{C}$	-	164	-		
Peak recovery current, per leg	I_{RRM}	$T_J = 25\text{ }^\circ\text{C}$	$I_F = 50\text{ A}$ $di_F/dt = 500\text{ A}/\mu\text{s}$ $V_R = 200\text{ V}$	-	16	-	A
		$T_J = 125\text{ }^\circ\text{C}$		-	33	-	
Reverse recovery charge, per leg	Q_{rr}	$T_J = 25\text{ }^\circ\text{C}$		-	794	-	nC
		$T_J = 125\text{ }^\circ\text{C}$		-	2736	-	

THERMAL - MECHANICAL SPECIFICATIONS						
PARAMETER	SYMBOL	TEST CONDITIONS	MIN.	TYP.	MAX.	UNITS
Junction to case, single leg conducting	R_{thJC}		-	-	0.11	$^\circ\text{C}/\text{W}$
Junction to case, both leg conducting			-	-	0.055	
Case to heatsink, per module	R_{thCS}	Flat, greased surface	-	0.1	-	
Weight			-	30	-	g
Mounting torque		Torque to terminal	-	-	1.1 (9.7)	Nm (lbf. in)
		Torque to heatsink	-	-	1.3 (11.5)	Nm (lbf. in)
Case style			SOT-227			

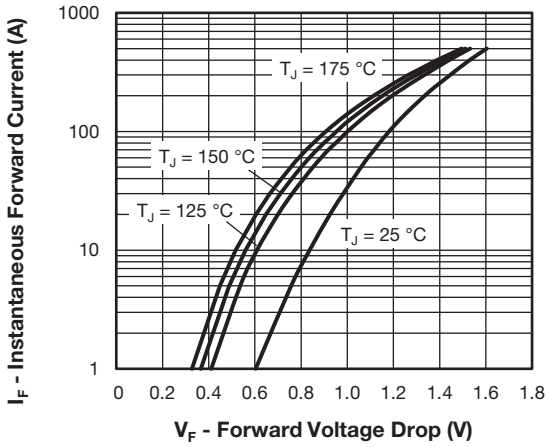

Fig. 1 - Typical Forward Voltage Drop vs. Instantaneous Forward Current (Per Diode)

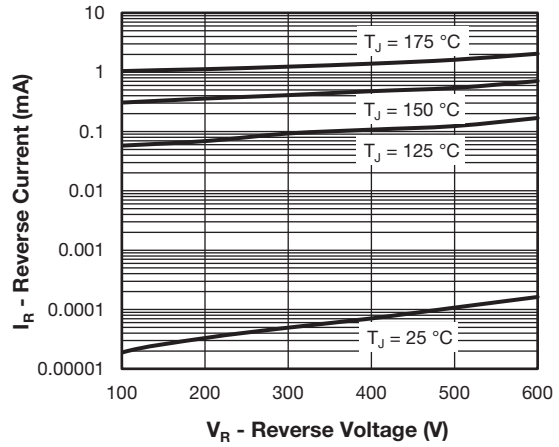

Fig. 2 - Typical Reverse Current vs. Reverse Voltage (Per Diode)

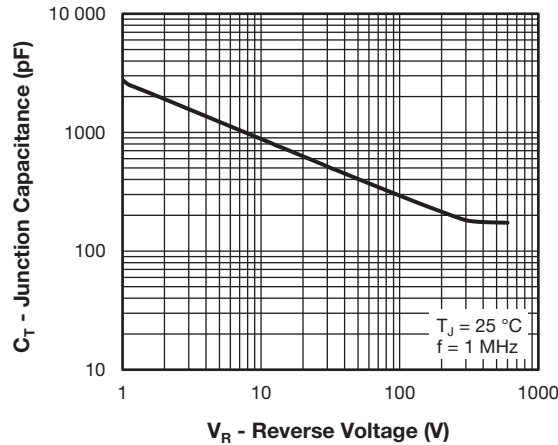

Fig. 3 - Typical Junction Capacitance vs Reverse Voltage (Per Diode)

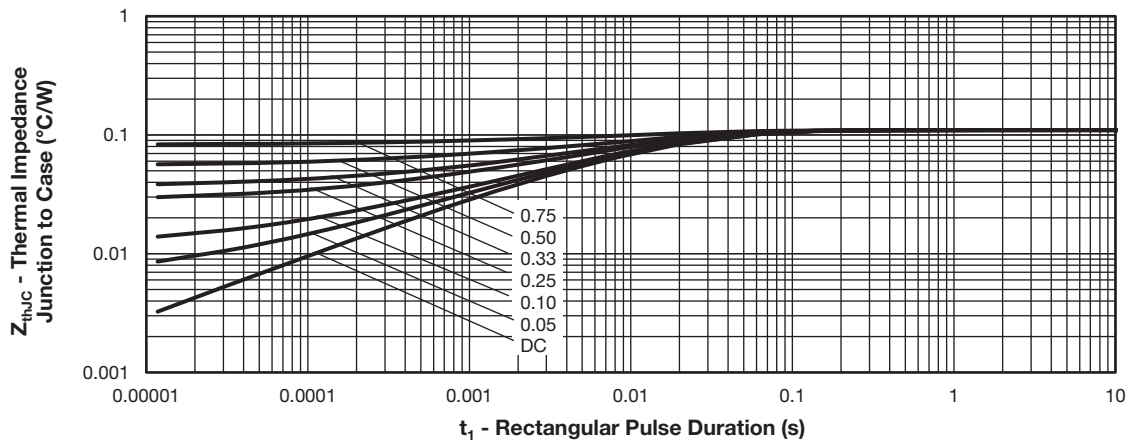

Fig. 4 - Maximum Thermal Impedance Junction-to-Case Characteristics (Per Diode)

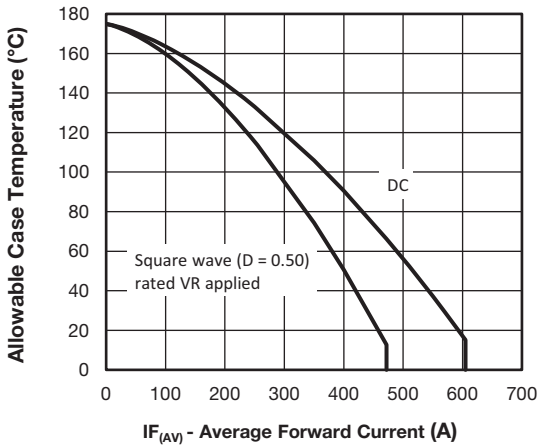

Fig. 5 - Maximum Current Rating Capability (Per Diode)

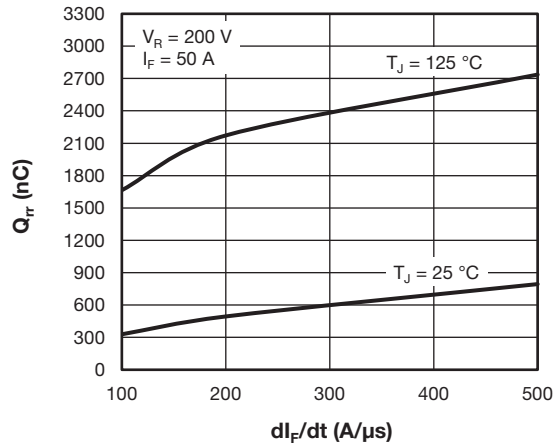

Fig. 7 - Typical Reverse Recovery Charge vs. dI_F/dt (Per Diode)

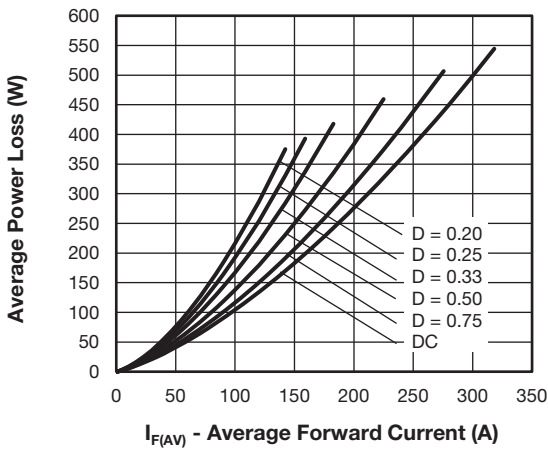

Fig. 6 - Forward Power Loss Characteristics (Per Diode)

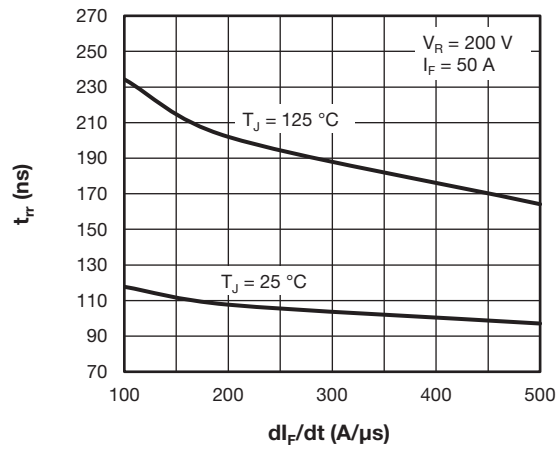

Fig. 8 - Typical Reverse Recovery Time vs. dI_F/dt (Per Diode)

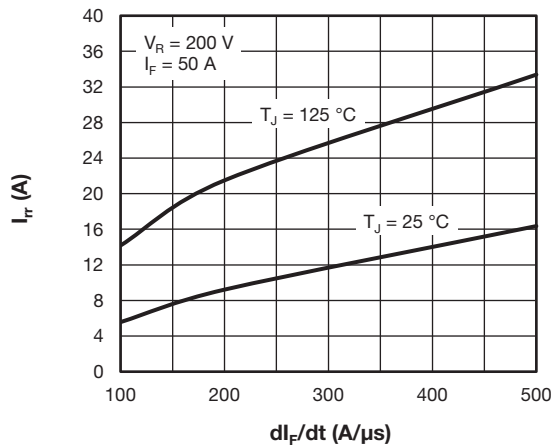

Fig. 9 - Typical Reverse Recovery Current vs. dI_F/dt (Per Diode)

ORDERING INFORMATION TABLE

Device code	VS-	UF	L	450	C	B	60
	①	②	③	④	⑤	⑥	⑦

- 1** - Vishay Semiconductors product
- 2** - Ultrafast rectifier
- 3** - Ultrafast Pt diffused, low V_F
- 4** - Current rating (450 = 450 A)
- 5** - Circuit configuration (2 common cathode diodes)
- 6** - Package indicator (SOT-227 standard not insulated)
- 7** - Voltage rating (60 = 600 V)

Quantity per tube is 10 pcs, M4 screw and washer included

CIRCUIT CONFIGURATION		
CIRCUIT	CIRCUIT CONFIGURATION CODE	CIRCUIT DRAWING
Common cathode	C	<p>Lead Assignment</p>

LINKS TO RELATED DOCUMENTS	
Dimensions	www.vishay.com/doc?95423
Part marking information	www.vishay.com/doc?95425



SOT-227 Generation 2

DIMENSIONS in millimeters (inches)

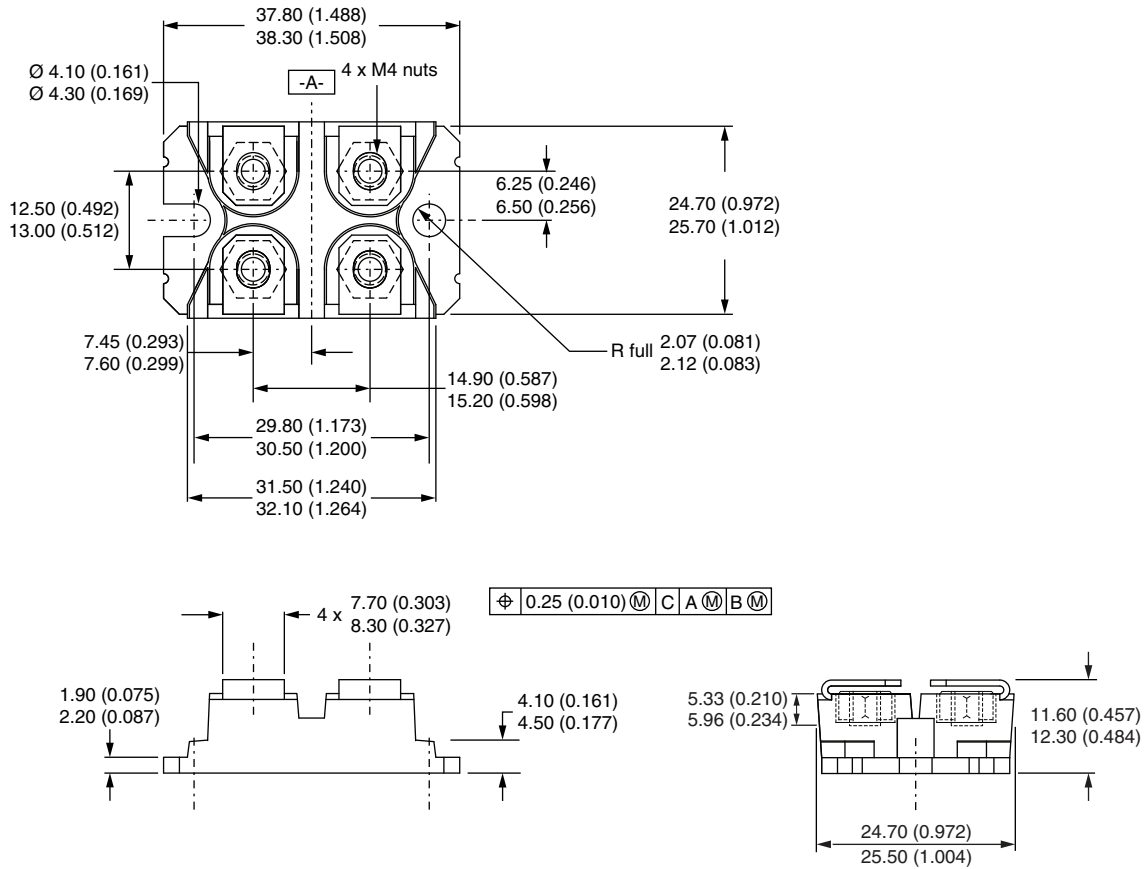

Note

- Controlling dimension: millimeter



Disclaimer

ALL PRODUCT, PRODUCT SPECIFICATIONS AND DATA ARE SUBJECT TO CHANGE WITHOUT NOTICE TO IMPROVE RELIABILITY, FUNCTION OR DESIGN OR OTHERWISE.

Vishay Intertechnology, Inc., its affiliates, agents, and employees, and all persons acting on its or their behalf (collectively, "Vishay"), disclaim any and all liability for any errors, inaccuracies or incompleteness contained in any datasheet or in any other disclosure relating to any product.

Vishay makes no warranty, representation or guarantee regarding the suitability of the products for any particular purpose or the continuing production of any product. To the maximum extent permitted by applicable law, Vishay disclaims (i) any and all liability arising out of the application or use of any product, (ii) any and all liability, including without limitation special, consequential or incidental damages, and (iii) any and all implied warranties, including warranties of fitness for particular purpose, non-infringement and merchantability.

Statements regarding the suitability of products for certain types of applications are based on Vishay's knowledge of typical requirements that are often placed on Vishay products in generic applications. Such statements are not binding statements about the suitability of products for a particular application. It is the customer's responsibility to validate that a particular product with the properties described in the product specification is suitable for use in a particular application. Parameters provided in datasheets and / or specifications may vary in different applications and performance may vary over time. All operating parameters, including typical parameters, must be validated for each customer application by the customer's technical experts. Product specifications do not expand or otherwise modify Vishay's terms and conditions of purchase, including but not limited to the warranty expressed therein.

Hyperlinks included in this datasheet may direct users to third-party websites. These links are provided as a convenience and for informational purposes only. Inclusion of these hyperlinks does not constitute an endorsement or an approval by Vishay of any of the products, services or opinions of the corporation, organization or individual associated with the third-party website. Vishay disclaims any and all liability and bears no responsibility for the accuracy, legality or content of the third-party website or for that of subsequent links.

Except as expressly indicated in writing, Vishay products are not designed for use in medical, life-saving, or life-sustaining applications or for any other application in which the failure of the Vishay product could result in personal injury or death. Customers using or selling Vishay products not expressly indicated for use in such applications do so at their own risk. Please contact authorized Vishay personnel to obtain written terms and conditions regarding products designed for such applications.

No license, express or implied, by estoppel or otherwise, to any intellectual property rights is granted by this document or by any conduct of Vishay. Product names and markings noted herein may be trademarks of their respective owners.