

4

3

2

1

THIS DRAWING IS UNPUBLISHED. RELEASED FOR PUBLICATION 2010
 © COPYRIGHT 2010 BY TYCO ELECTRONICS CORPORATION. ALL RIGHTS RESERVED.

LOC	DIST	REVISIONS			
P	LTR	DESCRIPTION	DATE	DWN	APVD
E	B	BA	NEW RELEASE	06JULY2010	PT St.P

FOR FURTHER INFORMATION SEE DATA SHEET FOR
 SERIES LR, METAL FILM FIXED RESISTORS

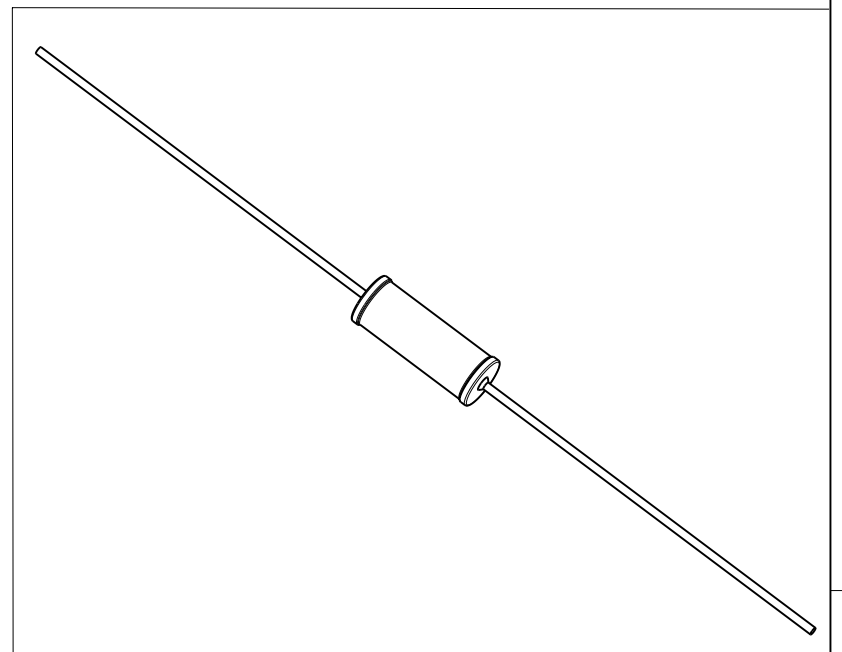
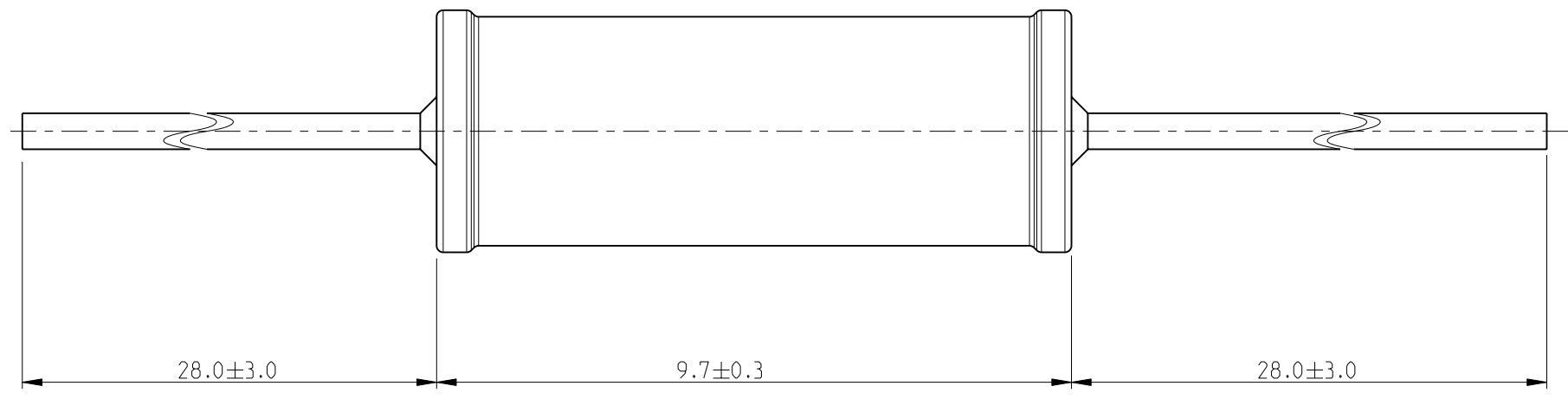
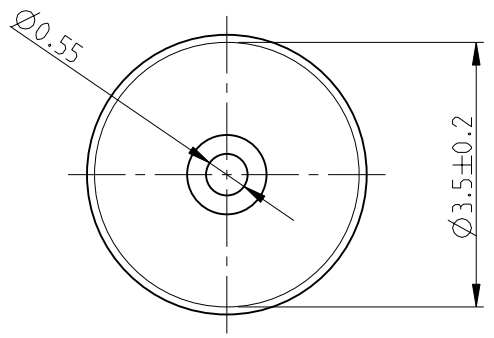

RoHS Compliant

<small>THIS DRAWING IS A CONTROLLED DOCUMENT FOR TYCO ELECTRONICS CORPORATION IT IS SUBJECT TO CHANGE AND THE CONTROLLING ENGINEERING ORGANIZATION SHOULD BE CONTACTED FOR THE LATEST REVISION.</small>		DWN 06JULY2010 PARUSURAM.T	Tyco Electronics Corporation Dorcan, Swindon, SN3 5HH	
DIMENSIONS: mm		CHK 06JULY2010 ALLAN.P	NAME METAL FILM FIXED RESISTORS SERIES LR2	
		APVD 06JULY2010 STEPHEN.P	PRODUCT SPEC -	
MATERIAL -		APPLICATION SPEC -	SIZE A3	CAGE CODE 00779
FINISH -		WEIGHT -	DRAWING NO C-1622761	RESTRICTED TO -
CUSTOMER DRAWING			SCALE 10:1	SHEET 1 OF 1
			REV BA	