

- 1 MATERIAL: HOUSING-NYLON, UL94V-0 (COLOR-NATURAL, COLOR OF PARTS MAY VARY) CONTACTS-0.25 [.010] THICK BRASS ALLOY.
- 2 TYCO ELECTRONICS LOGO AND MATERIAL ID MAY BE LOCATED ON EITHER LONG SIDE OF PART.
- 3 CONTACT FINISH: 0.002032 [.000080] MIN MATTE TIN OVER 0.000381 [.000015] MIN NICKEL OVER ENTIRE CONTACT.
- 4 MATES WITH VAL-U-LOK(TM) RECEPTACLE HOUSINGS.

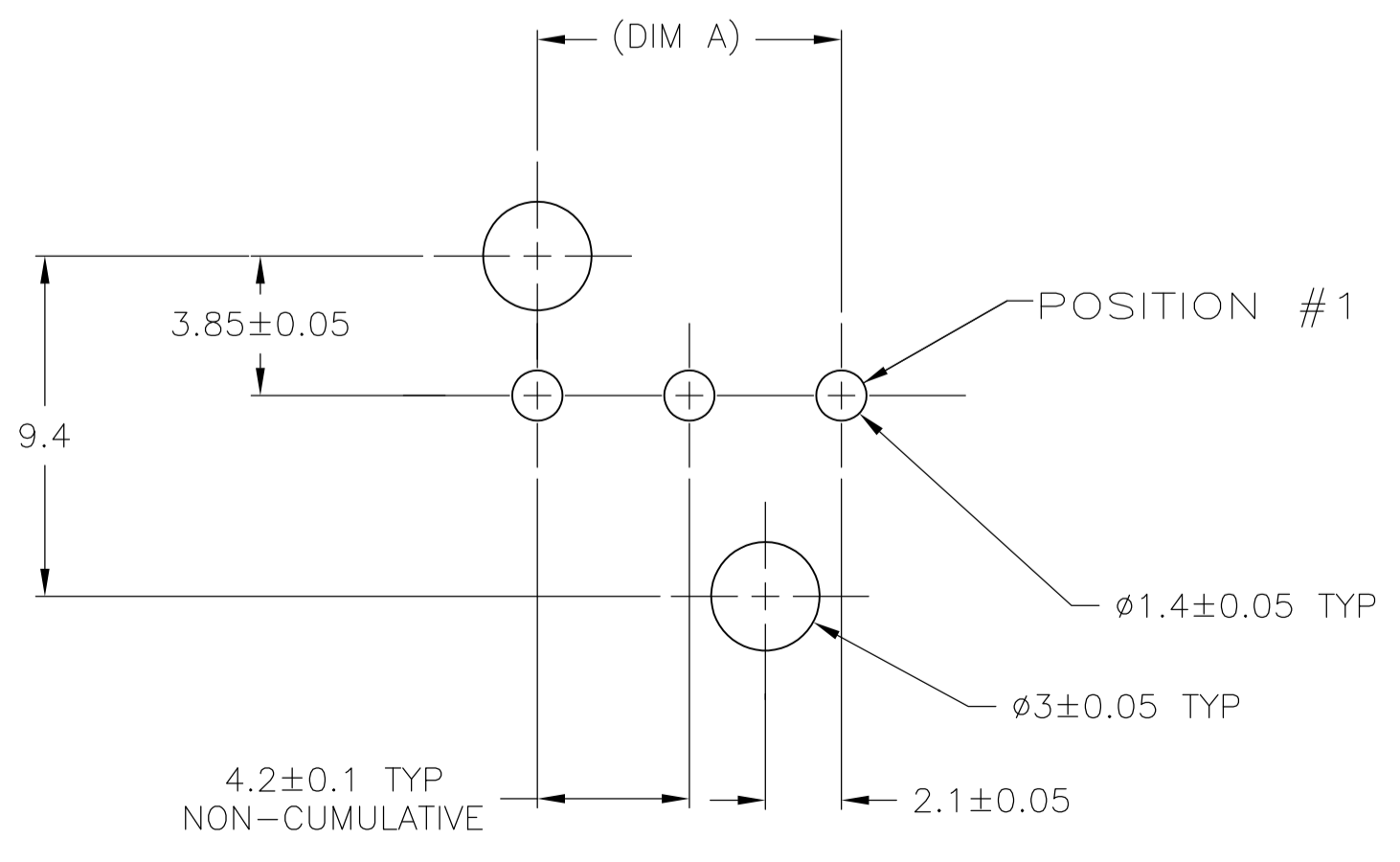

RECOMMENDED MOUNTING HOLE PATTERN FOR 1.78 MAX THICK P.C. BOARD COMPONENT SIDE SHOWN

22.2	16.8	5	2029056-5
18	12.6	4	2029056-4
13.8	8.4	3	2029056-3
DIM B	DIM A	NO. OF POSITIONS	PART NO

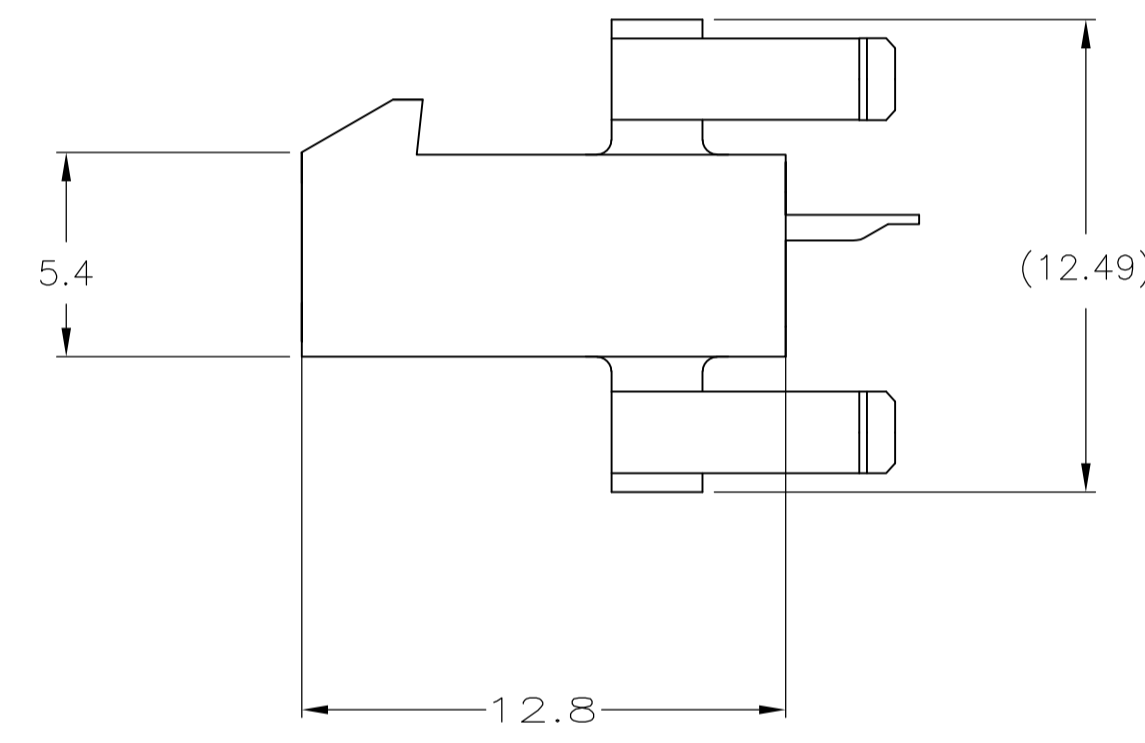
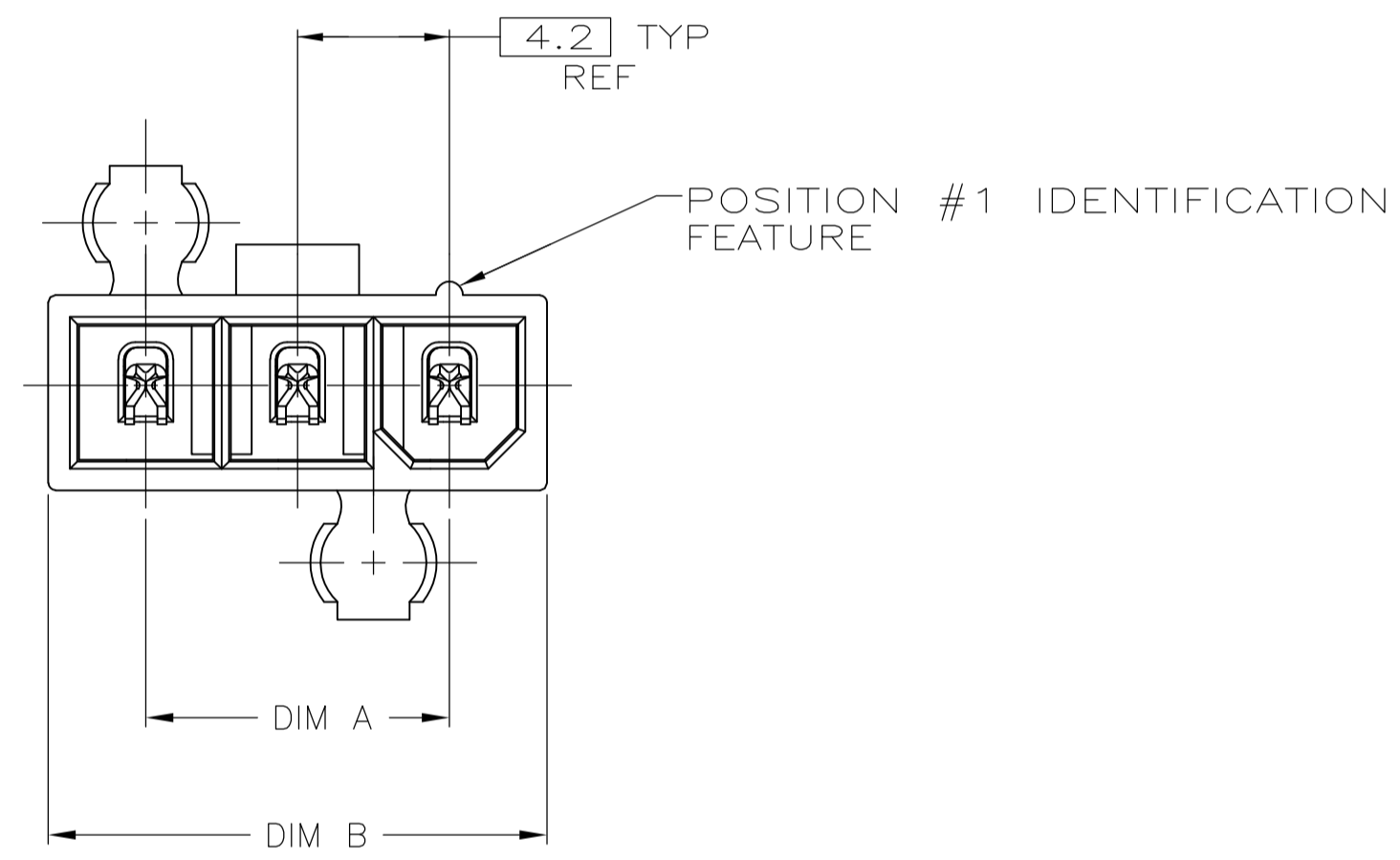
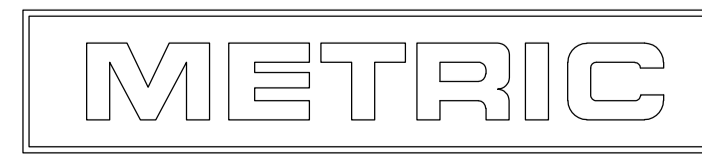

THIS DRAWING IS A CONTROLLED DOCUMENT.		DIN K. WHITAKER 11JAN2008		TE Connectivity	
DIMENSIONS: mm		CHK C. CASH 11JAN2008			
TOLERANCES UNLESS OTHERWISE SPECIFIED:		APVD C. CASH 11JAN2008		NAME	
0 PLC ± -		PRODUCT SPEC		PLUG ASSEMBLY, VERTICAL, SINGLE ROW, 94V-0, W/DRAIN HOLES, VAL-U-LOK(TM)	
1 PLC ± 0.2		APPLICATION SPEC		SIZE	
2 PLC ± 0.13		WEIGHT		CAGE CODE DRAWING NO	
3 PLC ± -		CUSTOMER DRAWING		A1 00779 C=2029056	
4 PLC ± -		SCALE 5:1		SHEET 1 OF 1	
ANGLES ± 0°30'		REV A2			