

CBT-90-G

Thermally Enhanced LED Package



Table of Contents

Technology Overview2

Binning Structure3

Ordering Information4

Optical and Electrical
Characteristics5

Angular Distribution and
Spectrum8

Thermal Resistance9

Mechanical Dimensions .. 10

Packaging Information ... 11

Revision History 13

Features

- Large, monolithic chip with uniform emitting area of 9 mm²
- Wide color gamut available for Green single color LEDs. Red, Blue, White and UV CBT-90 LEDs are also available with the same package format
- Ultra High thermal conductivity package allows operation at up to 27A CW
- High precision LEDs placement on copper core PCB for easier thermal management and optical integration
- Unencapsulated die with low profile protective window optimizes optical coupling in etendue-limited applications
- Environmentally friendly: RoHS and REACH compliant

Applications

- Fiber-coupled Illumination
- Architectural and Entertainment Lighting
- Medical Lighting
- Machine Vision
- Microscopy
- Displays and Signage
- General Illumination
- Spot Lighting
- Emergency Vehicle Lighting
- Projection Systems

Technology Overview

Luminus LEDs benefit from a suite of innovations in the fields of chip technology, packaging and thermal management. These breakthroughs allow illumination engineers and designers to achieve solutions that are high brightness and high efficiency.

Luminus LED Technology

Luminus' Devices vertical chip LED technology enables large area LED chips with uniform brightness over the entire LED chip surface. The optical power and brightness produced by these large monolithic chips enable solutions which replace arc and halogen lamps where arrays of traditional high power LEDs cannot.

Packaging Technology

Thermal management is critical in high power LED applications. With a thermal resistance from junction to heat sink of 0.5° C/W, Luminus CBT-90 LEDs have the lowest thermal resistance of any LED on the market. This allows the LED to be driven at higher current densities while maintaining a low junction temperature, thereby resulting in brighter solutions and longer lifetimes.

Environmental Benefits

Luminus LEDs help reduce power consumption and the amount of hazardous waste entering the environment. All LED products manufactured by Luminus are RoHS compliant and free of hazardous materials, including lead and mercury.

Reliability

Designed from the ground up, Luminus LEDs are one of the most reliable light sources in the world today. Luminus LEDs have passed a rigorous suite of environmental and mechanical stress tests, including mechanical shock, vibration, temperature cycling and humidity, and have been fully qualified for use in extreme high power and high current applications. With very low failure rates and median lifetimes that typically exceed 60,000 hours, Luminus LEDs are ready for even the most demanding applications.

Static Electricity

The products are sensitive to static electricity, and care should be taken when handling them. Static electricity or surge voltage will damage the LEDs. It is recommended to wear an anti-electrostatic wristband or an anti-electrostatic gloves when handling the LEDs. All devices, equipment and machinery must be properly grounded. It is recommended that measures be taken against surge voltage to the equipment that mounts the LEDs.

Reference: APN-002815 Electrical Stress Damage to LEDs and How to Prevent It

Understanding Luminus LED Test Specifications

Every Luminus LED is fully tested to ensure that it meets the high quality standards expected from Luminus' products.

Testing of Luminus LEDs

Luminus core board products are typically measured in such a way that the characteristics reported agree with how the devices will actually perform when incorporated into a system. This measurement is accomplished by mounting the devices on a 40°C heat sink and allowing the device to reach thermal equilibrium while fully powered. Only after the device reaches

equilibrium are the measurements taken. This method of measurement ensures that Luminus LEDs perform in the field just as they are specified.

Expected flux values in real world operation can be extrapolated based on the information contained within this product data sheet.

Binning Structure

All CBT-90 monochromatic LEDs are tested for luminous flux/ dominant wavelength and placed into one of the following flux/ wave length bins. The binning structure is universally applied across each monochromatic color of the CBT-90 product line.

Flux Bins

Color	Luminous Flux Bin (FF) ³	Binning @ 13.5A, T _{hs} = 40°C ⁵	
		Minimum Flux (lm)	Maximum Flux (lm)
Green	CM	2,000	2,300
	CN	2,300	2,600
	CP	2,600	2,900
	CQ	2,900	3,200

Dominant Wavelength Bins

Color	Wavelength Bin ³	Binning @ 13.5A, T _{hs} = 40°C ⁵	
		Minimum Wavelength (nm)	Maximum Wavelength (nm)
Green	G2	510	515
	G3	515	520
	G4	520	525
	G5	525	530
	G6	530	535
	G7	535	540

Note 1: Luminus maintains a +/- 6% tolerance on flux measurements.

Note 2: Products are production tested then sorted and packed by bin.

Note 3: Individual bins are not orderable. Please refer to the Product Ordering information page for a list of orderable bin kits.

Note 4: Product test condition: 13.5A DC, 40°C heat sink temperature.

Note 5: T_{hs} = Testing Heat Sink Temperature.

Ordering Information

Part Number Nomenclature

CBT — 90 — G — L11 — <Bin kit>

Product Family	Chip Area	Color	Package Configuration	Bin Kit ¹
CBT: Copper-core PCB, no encapsulation	90: 9 mm ²	G= Green	Internal package code	Refer to ordering part numbers in this document

Ordering Part Numbers

Color	Luminous Flux		Wavelength Bins	Ordering Part Number
	Min. Flux Bin	Min. Flux		
Green	CM	2,000 lm	G2, G3, G4, G5, G6, G7	CBT-90-G-L11-CM100-R2
			G4, G5, G6	CBT-90-G-L11-CM101-R2

Note 1: Flux Bin listed is minimum bin shipped, higher bins may be included at Luminus' discretion.

Optical & Electrical Characteristics

Typical Device Performance

General Characteristics		Symbol	Green	Unit
Emitting Area			9.0	mm ²
Emitting Area Dimensions			3.0x3.0	mm x mm
Characteristics at Recommended Test Drive Current , $I_f^{1,2,3}$				
Reference Duty Cycle			100	%
Test Peak Drive Current	typ	I_F	13.5	A
Peak Luminous Flux ^{4,5,6}	typ	Φ_v	2,600	lm
Peak Radiometric Flux ^{4,5,6}	typ	Φ_r	5.5	W
Dominant Wavelength ⁴	typ	λ_d	527	nm
Peak Wavelength ⁴	typ	λ_d	520	nm
FWHM- Spectral bandwidth at 50% of Φ_v^4	typ		35	nm
Chromaticity Coordinates ⁷	typ	x	0.180	
	typ	y	0.721	
Forward Voltage	min	V_{Fmin}	2.6	V
	typ	V_F	3.1	V
	max	V_{Fmax}	4.0	V
Dynamic Resistance	typ	Ω_{dyn}	0.05	Ω
Device Thermal Characteristics				
Thermal Coefficient of Photometric Flux	typ		-0.2	% / °C
Thermal Coefficient of Radiometric Flux	typ		-0.2	% / °C
Forward Voltage Temperature Coefficient	typ		-4.7	mV/ °C

Optical & Electrical Characteristics

Absolute Maximum Ratings

	Symbol	Value	Unit
Absolute Minimum Current (CW or Pulsed) ^{8,9}		0.2	A
Absolute Maximum Current (CW) ¹⁰		27	A
Absolute Maximum Surge Current ¹⁰ (Frequency > 240 Hz, duty cycle =10%, t=1ms)		31.5	A
Absolute Maximum Junction Temperature ¹⁰	T _{Jmax}	150	°C
Storage Temperature Range		-40/+100	°C

Note 1: All ratings are based on operation with a constant heat sink temperature T_{hs} =40°C. See Thermal Resistance section for T_{hs} definition.

Note 2: CBT-90-G device can be driven at currents ranging from 200mA to 27A and at duty cycles ranging from 1% to 100%. Drive current and duty cycle should be adjusted as necessary to maintain the junction temperature desired to meet application lifetime requirements. In pulsed operation, rise time from 10-90% of forward current should be larger than 0.5 microseconds.

Note 3: Tested at Current Density of 1.5 A/mm².

Note 4: Unless otherwise noted, values listed are typical. Devices are production tested and specified at 13.5 A.

Note 5: Total flux from emitting area at listed dominant wavelength. Reported performance is included to show trends for a selected power level. For specific minimum and maximum values, use bin tables. For product roadmap and future performance of devices, contact Luminus.

Note 6: Caution must be taken not to stare at the light emitted from these LEDs. Under special circumstances, the high intensity could damage the eye.

Note 7: In CIE 1931 chromaticity diagram coordinates, normalized to X+Y+Z=1.

Note 8: For reference only.

Note 9: Special design considerations must be observed for operation under 1 A. Please contact Luminus for further information.

Note 10: CBT-90-G LED is designed for operation to an absolute maximum current and temperature as specified above. Product lifetime data is specified at recommended forward drive currents. Sustained operation at or beyond absolute maximum currents or temperatures will result in a reduction of device life ime compared to recommended conditions. Refer to the lifetime derating curves for further information.

Optical & Electrical Characteristics

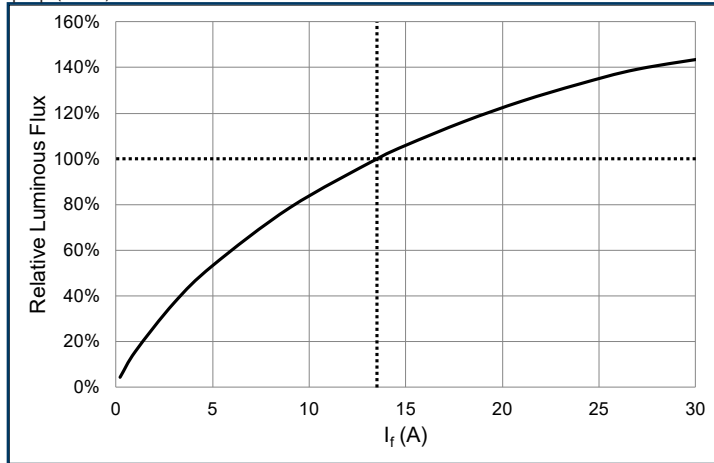
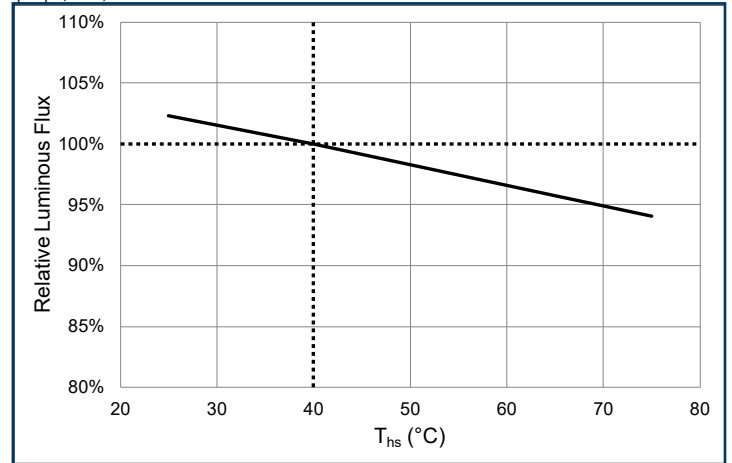
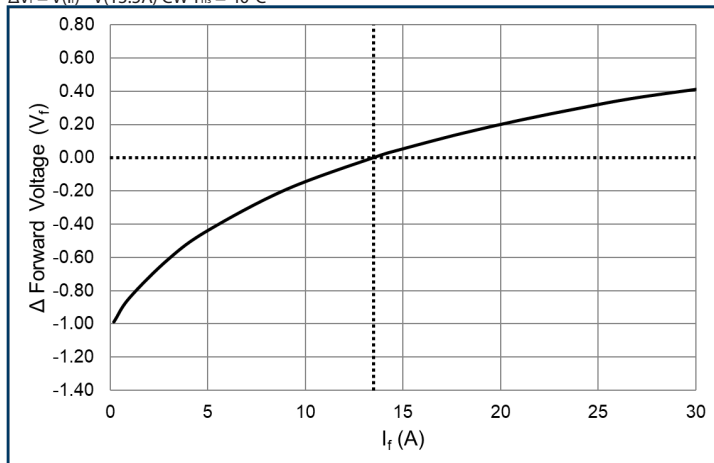
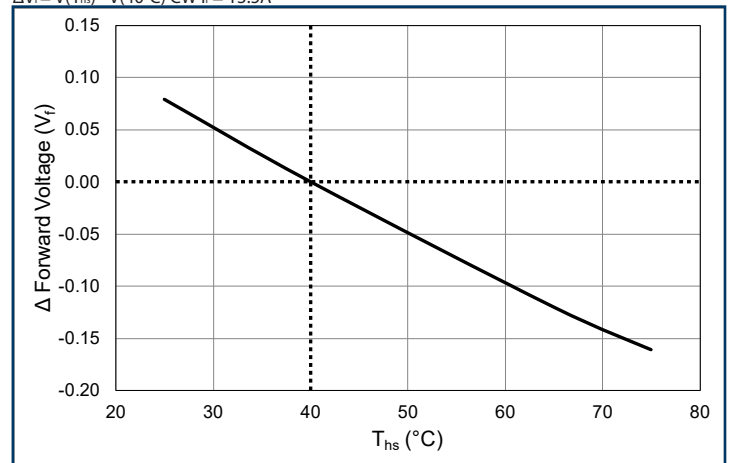
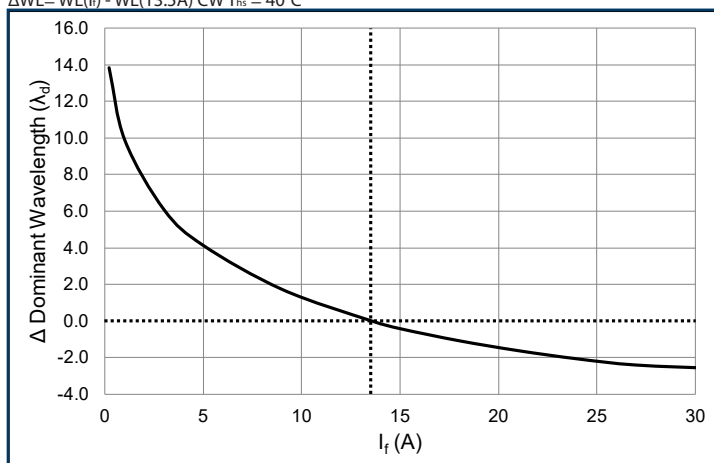
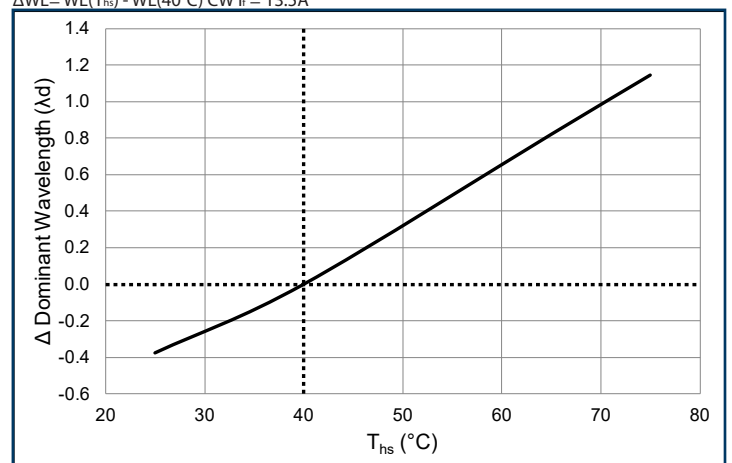
Relative Luminous Flux vs Forward Current
 $\phi_v/\phi_v(13.5A)$ CW $T_{hs} = 40^\circ C$

Relative Luminous Flux vs Temperature
 $\phi_v/\phi_v(40^\circ C)$ CW $I_f = 13.5A$

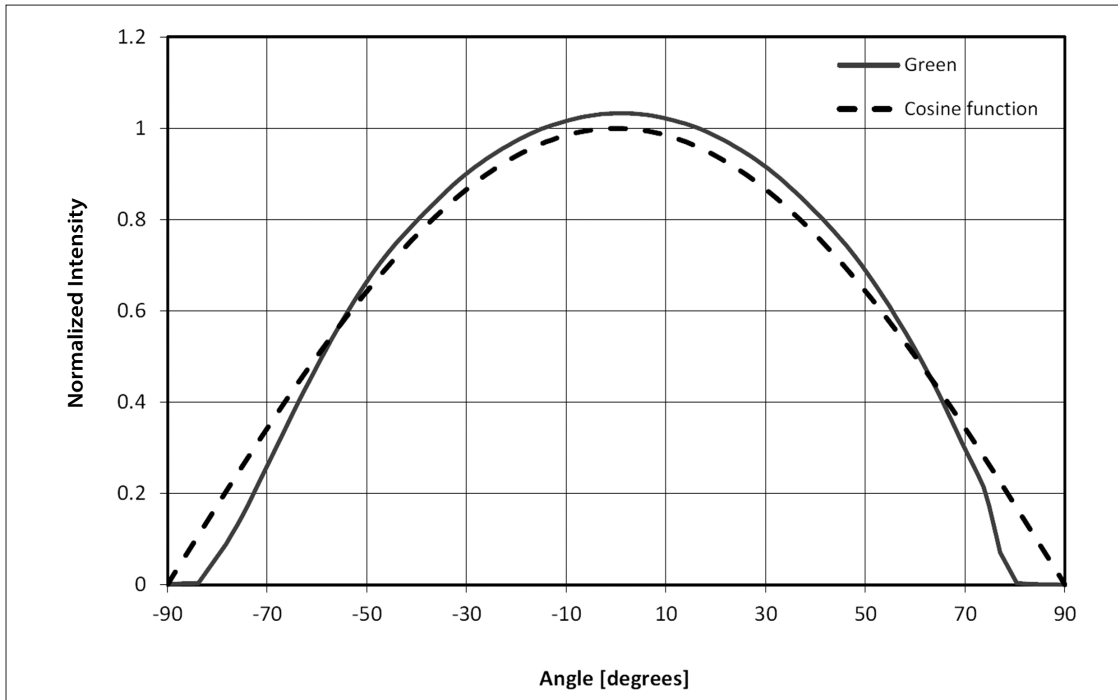
Relative Forward Voltage vs Forward Current
 $\Delta V_f = V(I_f) - V(13.5A)$ CW $T_{hs} = 40^\circ C$

Relative Forward Voltage vs Temperature
 $\Delta V_f = V(T_{hs}) - V(40^\circ C)$ CW $I_f = 13.5A$

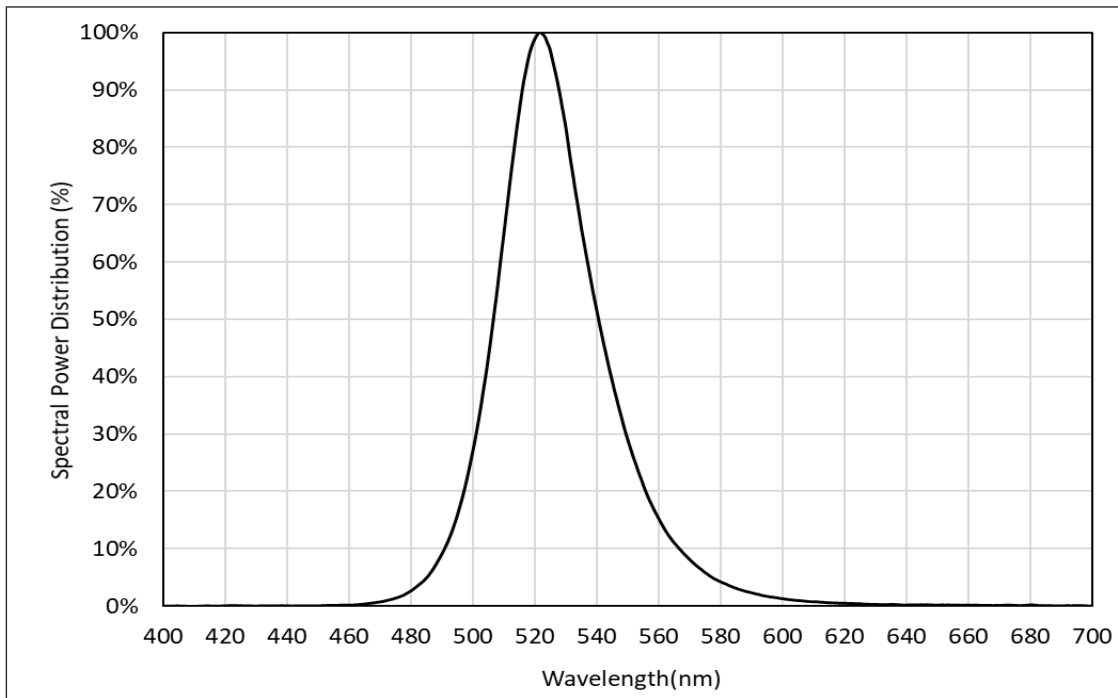
Dom Wavelength Shift vs Forward Current
 $\Delta WL = WL(I_f) - WL(13.5A)$ CW $T_{hs} = 40^\circ C$

Dom Wavelength Shift vs Temperature
 $\Delta WL = WL(T_{hs}) - WL(40^\circ C)$ CW $I_f = 13.5A$

Angular Intensity Distribution (Typical)



Typical Spectrum



Thermal Resistance

Typical Thermal Resistance

$R_{\theta j-b}^{-1}$	0.5 °C/W
$R_{\theta b-hs}^{-1}$	0.1 °C/W
$R_{\theta j-hs}^{-2}$	0.6 °C/W
$R_{\theta j-ref}^{-1}$	0.5 °C/W

Note 1: Thermal resistance values are based on FEA model results correlated to measured $R_{\theta j-hs}$ data.

Note 2: Thermal resistance is measured using eGraf 1205 thermal interface material.

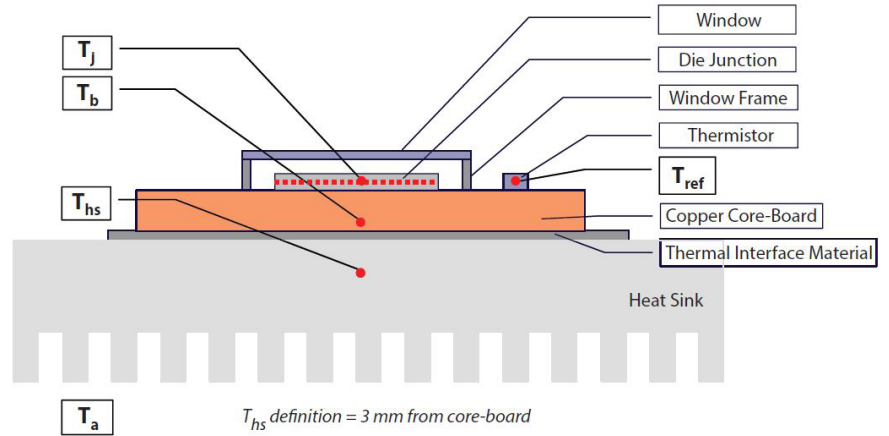

Thermistor Information

The thermistor used in CBT-90-G LED mounted on core-boards is from Murata Manufacturing Co. The global part number is NCP18XH103J03RB. Please see <http://www.murata.com/> for details on calculating thermistor temperature.

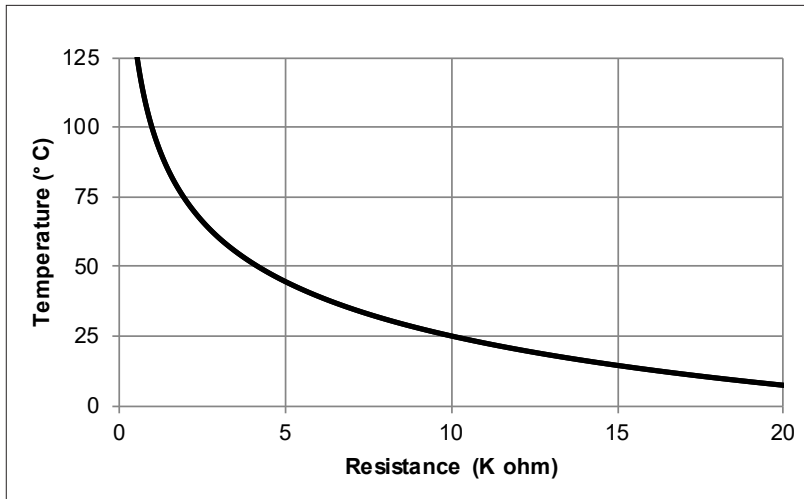

Electrical Pinout

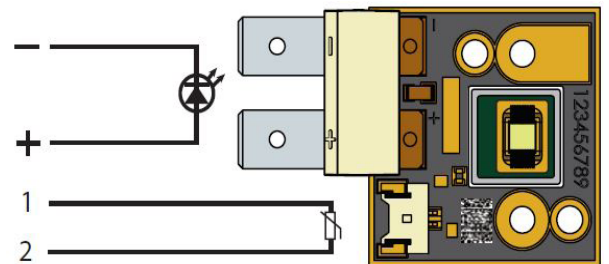

Mechanical Dimensions



GREEN LED DEVICE

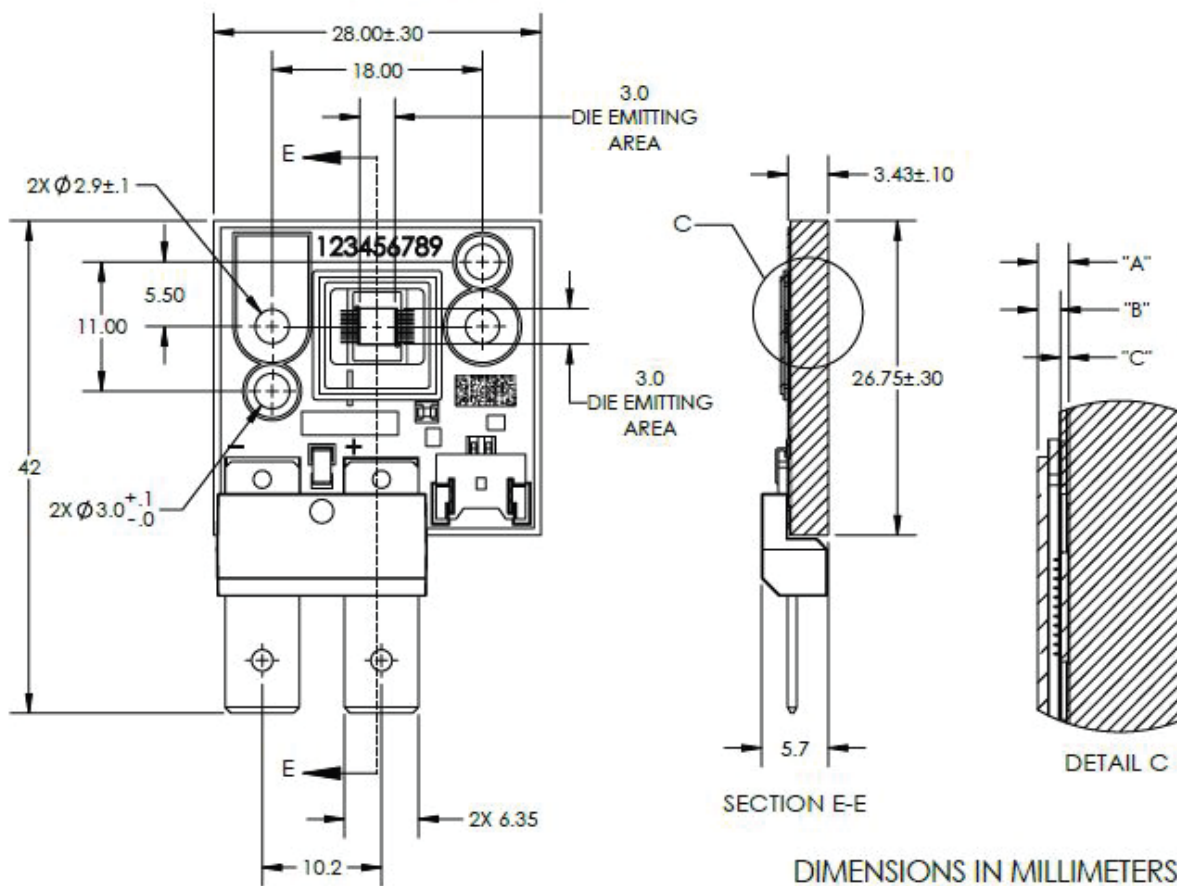

DIMENSIONS IN MILLIMETERS

DIMENSION NAME	DESCRIPTION	NOMINAL DIMENSION	TOLERANCE
"A"	TOP OF METAL SUBSTRATE TO TOP OF WINDOW	.88	$\pm .13$
"B"	TOP OF DIE EMITTING AREA TO TOP OF WINDOW	.65	$\pm .11$
"C"	TOP OF METAL SUBSTRATE TO TOP OF DIE EMITTING AREA	.23	$\pm .02$

Recommended connector for Anode and Cathode:

Panduit Disco Lok™ Series P/N: DNF14-250FIB-C or JST Manufacturing Co: SPS-61T-250 for AWG 16 to 14

Panduit Disco Lok™ Series P/N: DNF10-250FIB-L or JST Manufacturing Co: SPS-91T-250 for AWG 12 to 10

(Check NEC standards for ampacity of the power cable being used)

Recommended Female: MOLEX P/N 51146-0200 (not recommended for new designs), GCT P/N WTB06-020H-A or equivalent

For detailed drawing please refer to DWG-002309 document

Shipping Tray Outline

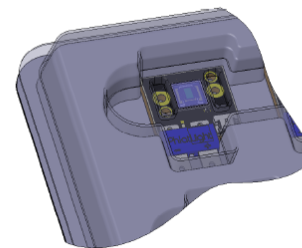
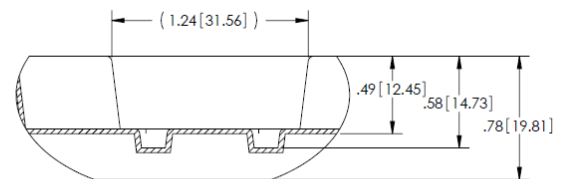
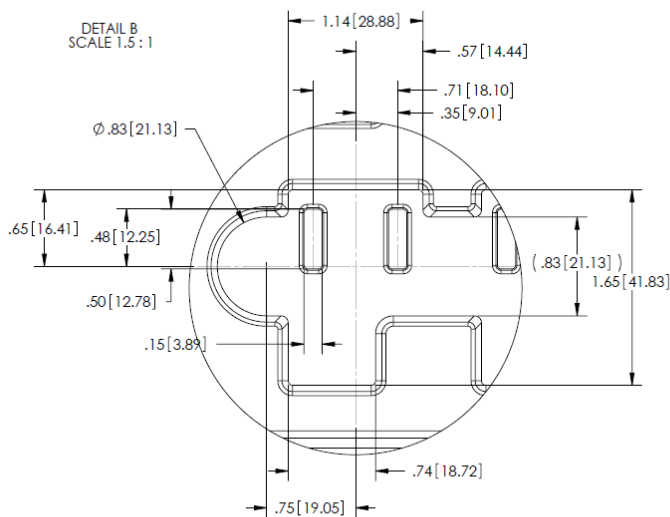
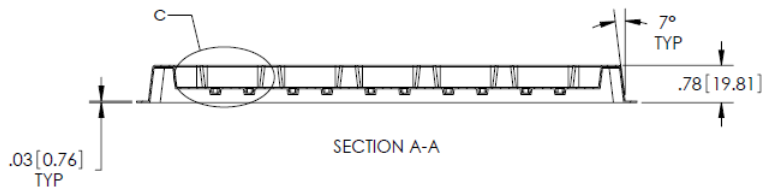
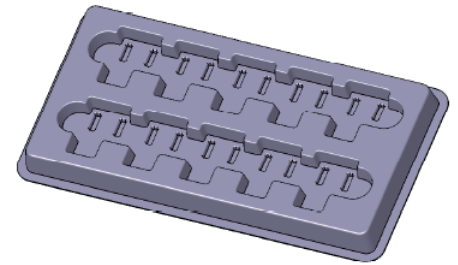
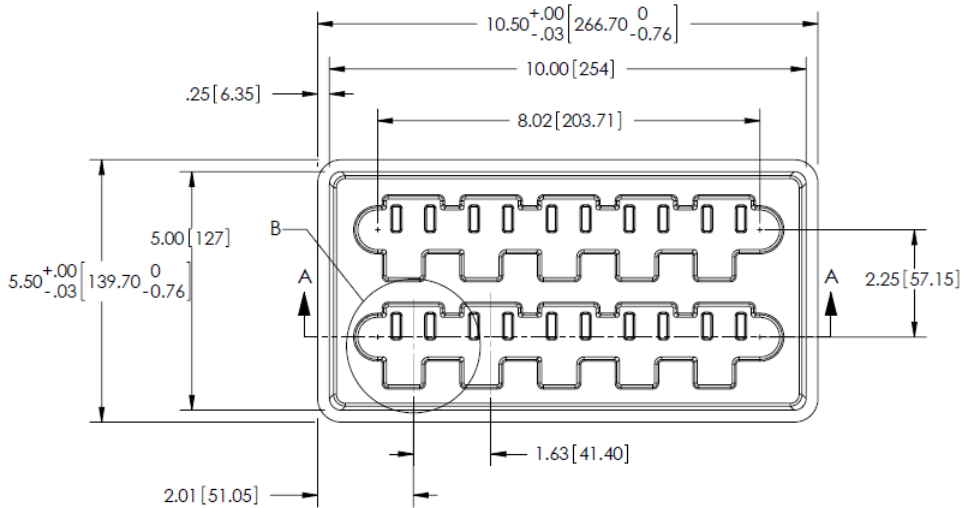

TOP TRAY SHOWN TRANSPARENT FOR REFERENCE ONLY

Shipping Label

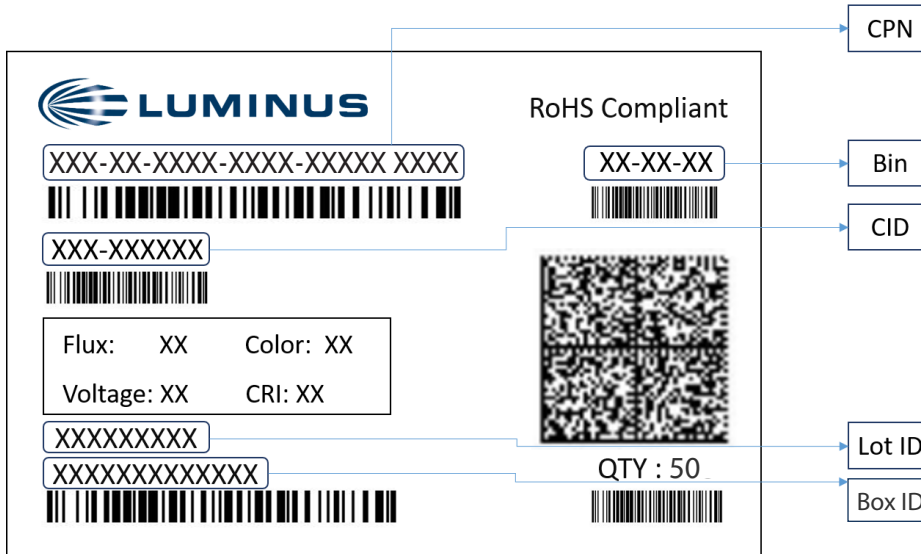
Label Fields:

- CPN: Luminus ordering part number
- CID: Customer's part number
- QTY: Quantity of devices in pack
- Flux: Bin as defined on page 3
- Voltage: NA
- Color: Bin as defined on page 3
- CRI: NA

Packing Configuration:

- Maximum: stack of 5 trays with 10 devices per tray per pack
- Each pack is enclosed in antistatic bag
- Shipping label is placed on top of each pack

Revision History

Rev	Date	Description of Change
01	02/09/2022	Initial Release

Luminus Devices assumes no liability for errors that may appear in this document, and no liability otherwise arising from the application or use of the product or information contained herein. None of the information provided herein should be considered to be a representation of the fitness or suitability of the product for any particular application or as any other form of warranty. Luminus Devices' product warranties are limited to only such warranties as accompany a purchase contract or purchase order for such products. Nothing herein is to be construed as constituting an additional warranty. No information contained in this publication may be considered as a waiver by Luminus Devices of any intellectual property rights that Luminus Devices may have in such information.

This product is protected by U.S. Patents 6,831,302; 7,074,631; 7,083,993; 7,084,434; 7,098,589; 7,105,861; 7,138,666; 7,166,870; 7,166,871; 7,170,100; 7,196,354; 7,211,831; 7,262,550; 7,274,043; 7,301,271; 7,341,880; 7,344,903; 7,345,416; 7,348,603; 7,388,233; 7,391,059 Patents Pending in the U.S. and other countries.