

Press-Fit Card Edge Connectors 0.100" (2.54mm) Pitch

Features:

- 0.100" (2.54mm) contact spacing x 0.200" (5.08mm) row spacing
- Accepts 0.062" (1.57mm) nominal thickness P.C. board
- Low profile insulator body, 0.550" (13.97mm)
- Contact termination options include P.C. tail, and 0.025" (0.64mm) square wire wrap
- Press-Fit compliant section for gas tight reliable connection in plated through holes eliminates soldering operations
- Single or dual row configurations
- Accepts between contact and in-contact polarizing keys (special features if requested)
- Tools available for insulator and contact removal. Simple "flat rock" tooling is used for connector installation
- RoHS Compliant & UL Certified

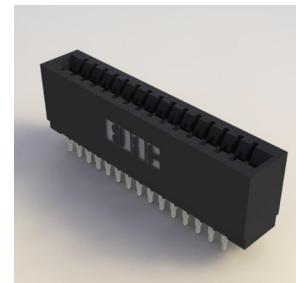

Specifications:

Insulator Material	UL 94V-0 Thermoplastic Polyester, Black
Contact Material	Copper Alloy
Contact Plating	30µ" Gold Plating on mating area and Tin Plating on tails with Nickel underplating all over
Current Rating	3 amps
Contact Resistance	10 milliohms Maximum
Dielectric Withstanding Voltage	1200 V AC rms at sea level between adjacent contacts
Insulation Resistance	5000 megaohms Minimum
Operating Temperature	-40°C to +105°C
Insertion Force	16 oz (4.45 N) maximum per contact pair when tested with .070" (1.78mm) thick gauge
Withdrawal Force	1 oz (0.28 N) minimum per contact pair when tested with .054" (1.37mm) thick gauge
Contact insertion into Hole	20 lbs (89 N) Maximum
Contact Retention in Hole	10 lbs (44 N) Minimum
Re-Insertability in same Hole	3 Times Minimum

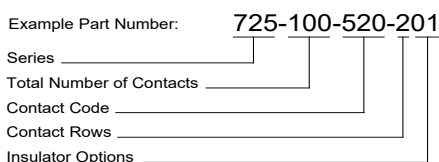

Series:

725

Total Number of Contacts: Contact Rows:

005, 006, . . . 075

Single Row

010, 012, . . . 150

Dual Row

Contact Code: Description: Contact Point: Tail Length "G":

520	P.C. Tail	Regular Point	.190 (4.83)
522	P.C. Tail	Regular Point	.375 (9.53)
525	P.C. Tail	High Point	.190 (4.83)
540	Wire Wrap	Regular Point	.560 (14.22)
541	Wire Wrap	Regular Point	.750 (19.05)
545	Wire Wrap	High Point	.560 (14.22)
560	Make Before Break (MBB) Contacts		.190(4.83)

Contact Rows: Description:

1 Single Row

2 Dual Row

Insulator Options: Description:

01 .550" (13.97mm)

BETWEEN CONTACT
POLARIZING KEY
P/N 341-240-318

PROPOSED
IN-CONTACT
POLARIZING KEY
P/N 725-240-328

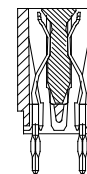
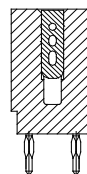

Ordering Code Notes:

- 1) All connector sizes up to 75 contacts single row / 150 contacts dual row are available upon request.
- 2) Make-Before-Break switching contacts, assembled in specific contact positions, are available upon request.

Press-Fit Card Edge Connectors 0.100" (2.54mm) Pitch

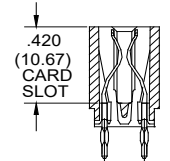
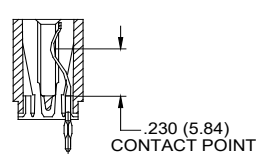
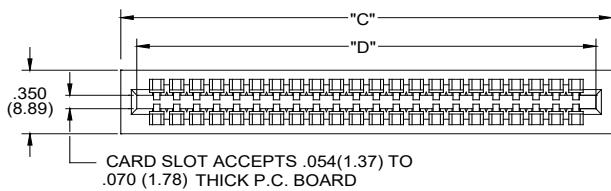

CODE 101
Single Row Versions May Require Backup Springs Depending upon the Application.

CODE 201

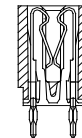
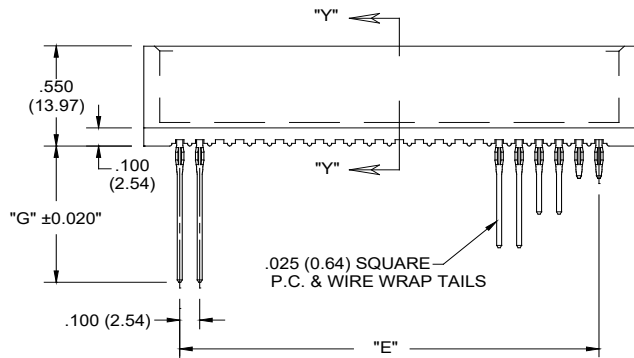

MAKE BEFORE BREAK (M.B.B) POINT CONTACTS

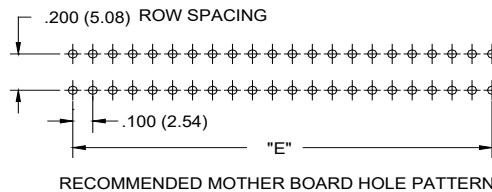
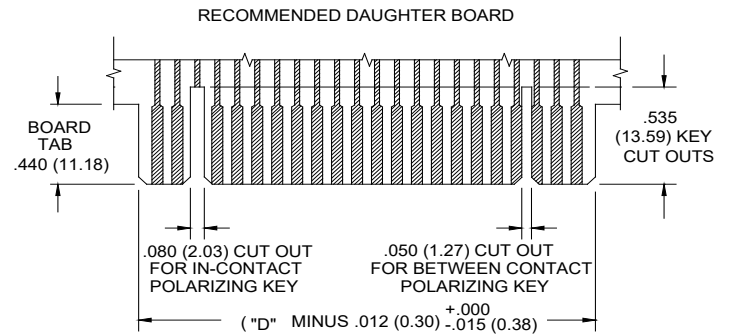
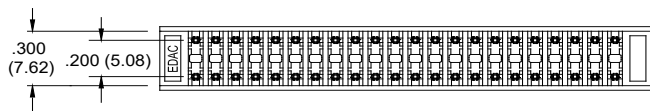

.040 (1.02) DIA ± .003 (0.08)
SEE NOTE BELOW
⌀ .008 (0.20) DIA

TO OBTAIN OPTIMUM COMPLIANT SECTION PERFORMANCE, DRILL HOLES .0453 ± .001 (1.15 ± 0.03) DIAMETER COPPER PLATE, .001 (25.4 MICRONS) MINIMUM THICKNESS, FOLLOWED BY TIN PLATE TO PROVIDE FINISHED HOLES .040 ± .003 (1.02 ± 0.08) DIAMETER

NUMBER OF CONTACTS		"C"		"D"		"E"	
Single	Double	Inch	mm	Inch	mm	Inch	mm
5	10	0.760	19.30	0.600	15.24	0.400	10.16
10	20	1.260	32.00	1.100	27.94	0.900	22.86
15	30	1.760	44.70	1.600	40.64	1.400	35.56
18	36	2.060	52.32	1.900	48.26	1.700	43.18
22	44	2.460	62.48	2.300	58.42	2.100	53.34
25	50	2.760	70.10	2.600	66.04	2.400	60.96
28	56	3.060	77.72	2.900	73.66	2.700	68.58
30	60	3.260	82.80	3.100	78.74	2.900	73.66
31	62	3.360	85.34	3.200	81.28	3.000	76.20
35	70	3.760	95.50	3.600	91.44	3.400	86.36
36	72	3.860	98.04	3.700	93.98	3.500	88.90
43	86	4.560	115.82	4.400	111.76	4.200	106.68
50	100	5.260	133.60	5.100	129.54	4.900	124.46
75	150	7.760	197.10	7.600	193.04	7.400	187.96