

DETAILS

Product Number	C14274_SHELLY-T-6X1-WAS
Family	Shelly
Type	Lens
Color	clear
Diameter	119,8 + 19,6 mm
Height	7,6 mm
Style	rectang
Optic Material	PMMA
Holder Material	
Fastening	pin, screw
Status	production ready
ROHS Compliant	Yes
Date Updated	16/06/2015



OPTICAL PROPERTIES

LED	Viewing Angle	Light Beam	Efficiency	cd/lm	Connector
XQ-E	asymmetric deg	Asymmetric	94 %	1.400	-
XQ-E HI	sim: Asymmetric	Asymmetric	sim: 93 %	sim: 1.500	-
LUXEON T	Asymmetric deg	Asymmetric	94 %	0.960	-
LUXEON Z ES	asymmetric deg	Asymmetric	94 %	1.400	-
LUXEON Rebel ES	Asymmetric deg	Asymmetric	94 %	1.000	-
LUXEON TX	Asymmetric deg	Asymmetric	94 %	0.980	-
NF2x757A	Asymmetric deg	Asymmetric	94 %	0.960	-
NCSxx19A	asymmetric deg	Asymmetric	94 %	1.100	-
NVSxx19A	asymmetric deg	Asymmetric	94 %	0.940	-
NCSxx19B	Asymmetric deg	Asymmetric	94 %	0.820	-
NVSxx19B/NVSxx19C	Asymmetric deg	Asymmetric	94 %	0.890	-
NF2x757G	sim: Asymmetric	Asymmetric	sim: 94 %	sim: 1.100	-
Duris S5 (2 chip)	asymmetric deg	Asymmetric	94 %	0.970	-

Bottom view

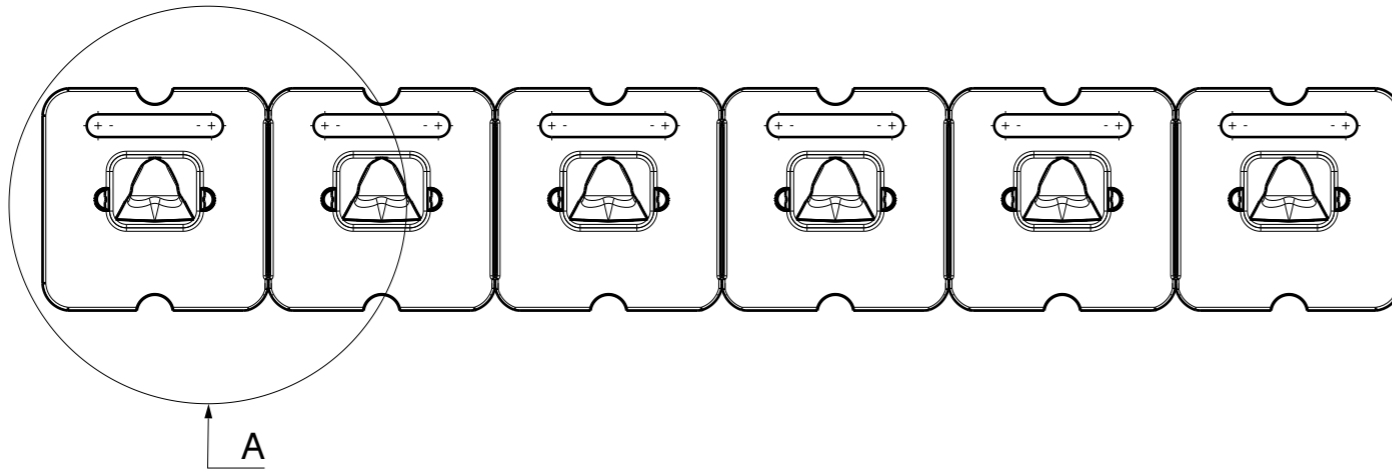

Front view

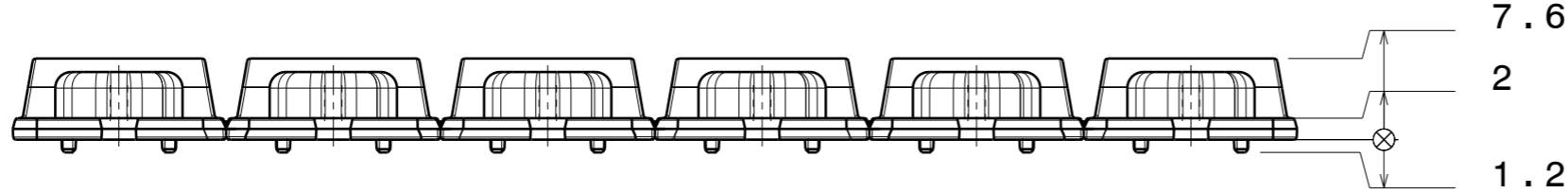

Top view

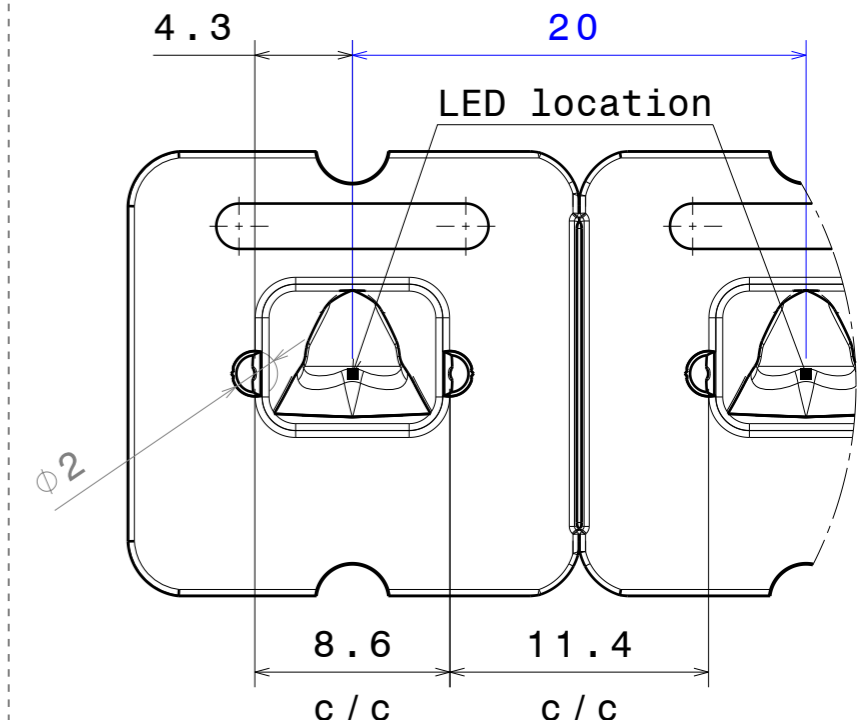
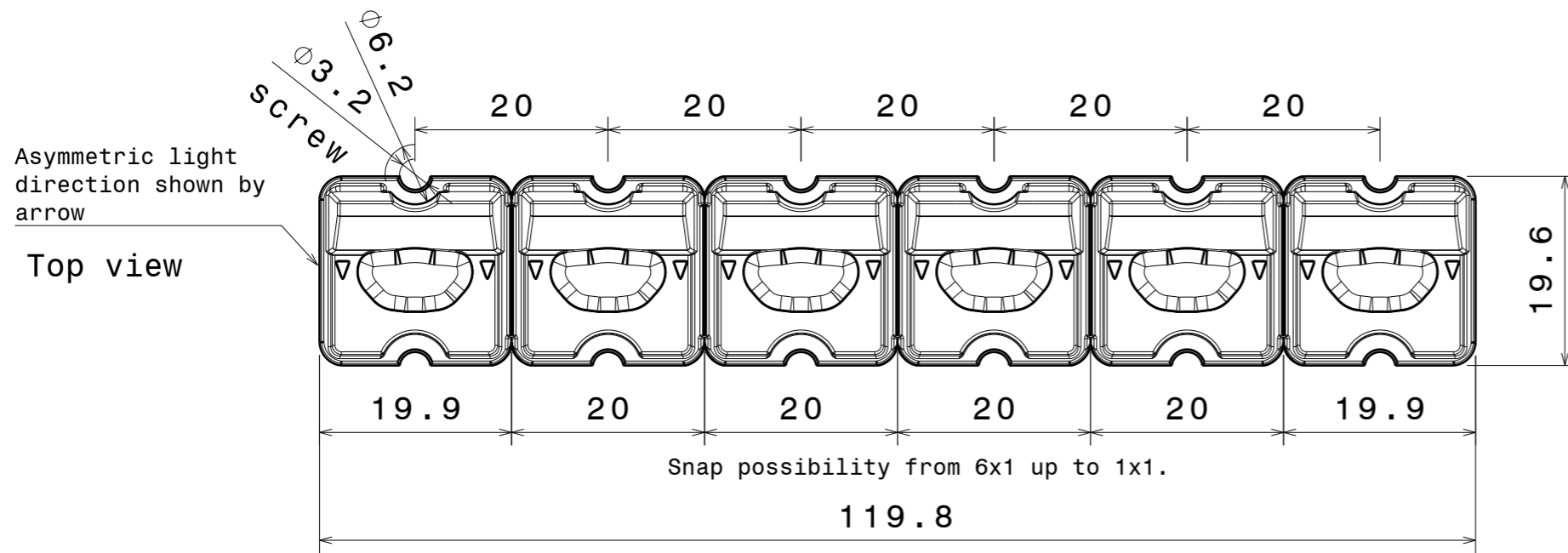

Detail A

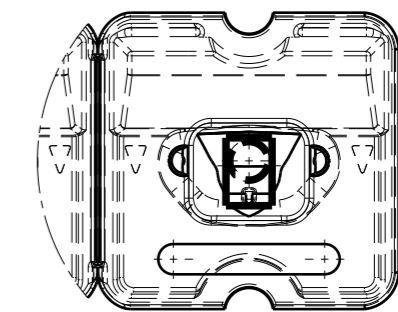

Led direction for Rebel / rebel-es / luxeon-r / luxeon-a LED types.

To ease assembly: two main 2mm position pins holes recommended to use - other holes larger sized or oval/oblong geometry.

($\phi 2.5$) example

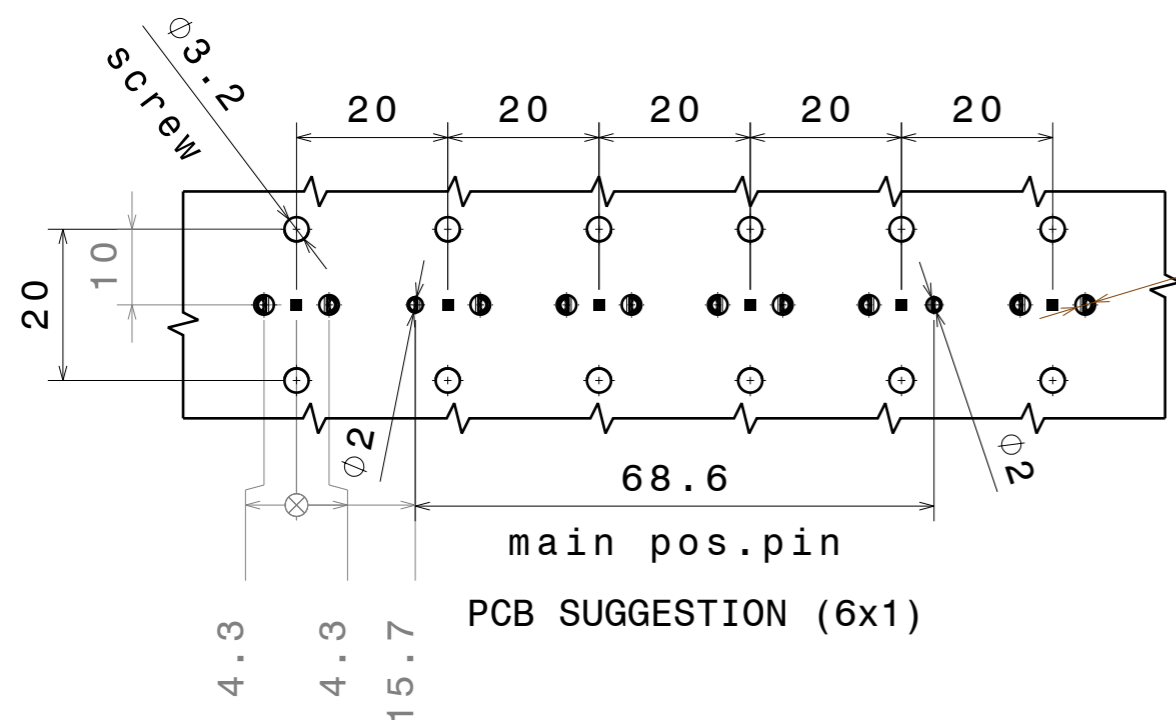

INDEX	PART NO	DESCRIPTION	MATERIAL	COLOUR
1	C14274	SHELLY-T-6X1-WAS	PMMA	

	LediL Oy Salorankatu 10 FIN 24240 SALO Finland			
	DRAWING TITLE			
C14274_SHELLY-T-6X1-WAS				
SIZE	PART NUMBER			
A3	C14274			
SCALE	1:1	WEIGHT	- g	SHEET 1/1

Tolerances if not otherwise shown
 According to DIN ISO 2768-1
 Linear measures:
 Up to 30mm class M, otherwise class C.
 According to DIN ISO 2768-2
 Form and position: class L

THIRD ANGLE PROJECTION:

This drawing is the property of LEDiL Oy. It may not be reproduced, copied or communicated without a written agreement with LEDiL Oy.

Luminaire: Ledil C14274_SHELLY-T-6X1-WAS_(Cree_XQ-E)

Lamps: 1 x Cree_XQ-E_(XQEAWT-0-7B1-Q40-0H-00001)_497.31lm@250mA_P=4.5957W_I=0.250A

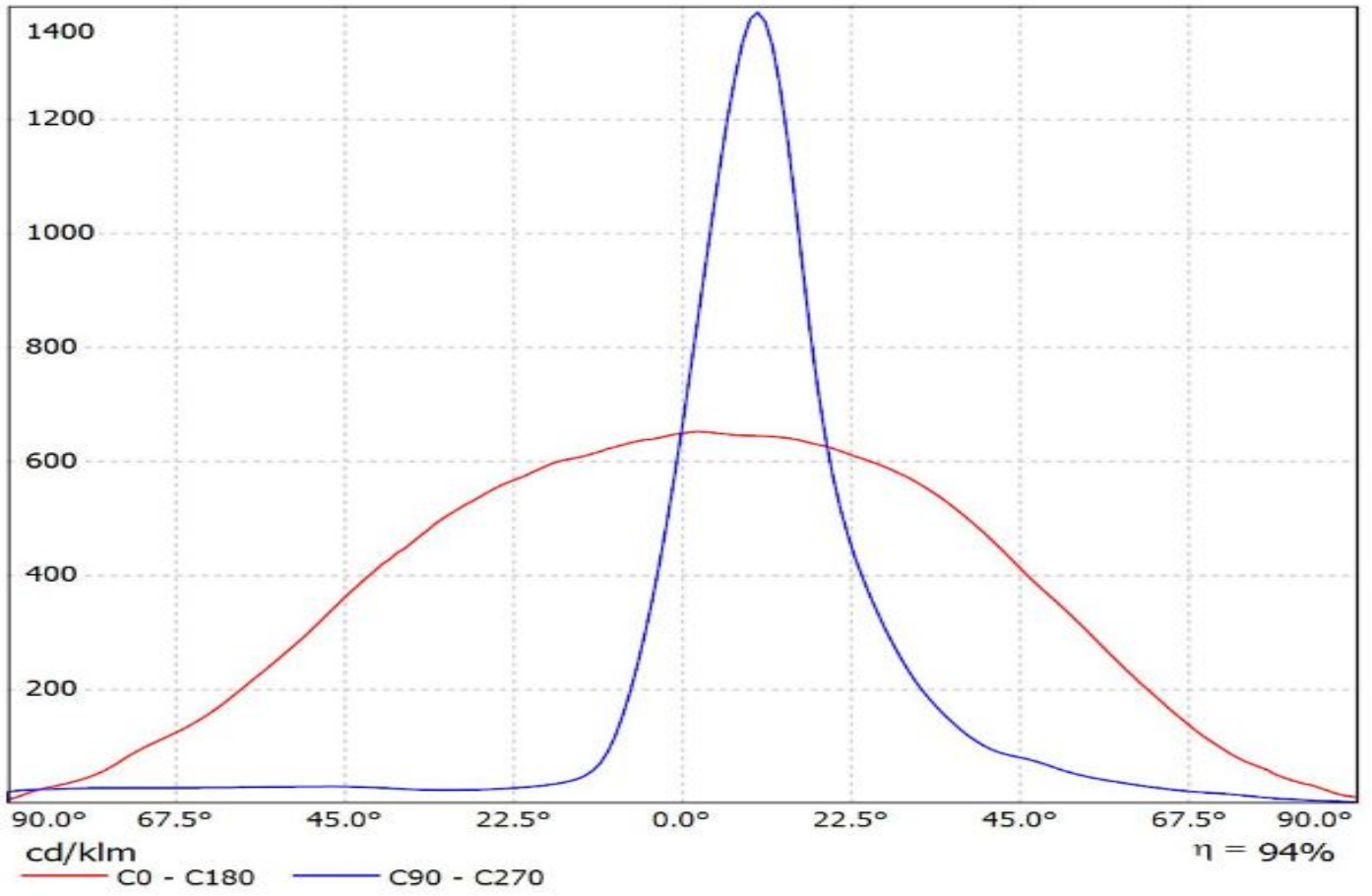

Luminaire: LEDiL Oy C14274_SHELLY-T-6X1-WAS_(LUXEON_T)
Lamps: 1 x LUXEON_T_1x6_(LXH8-FW30-3)_438.8lm@250mA_P=4.17608W_I=249.9mA

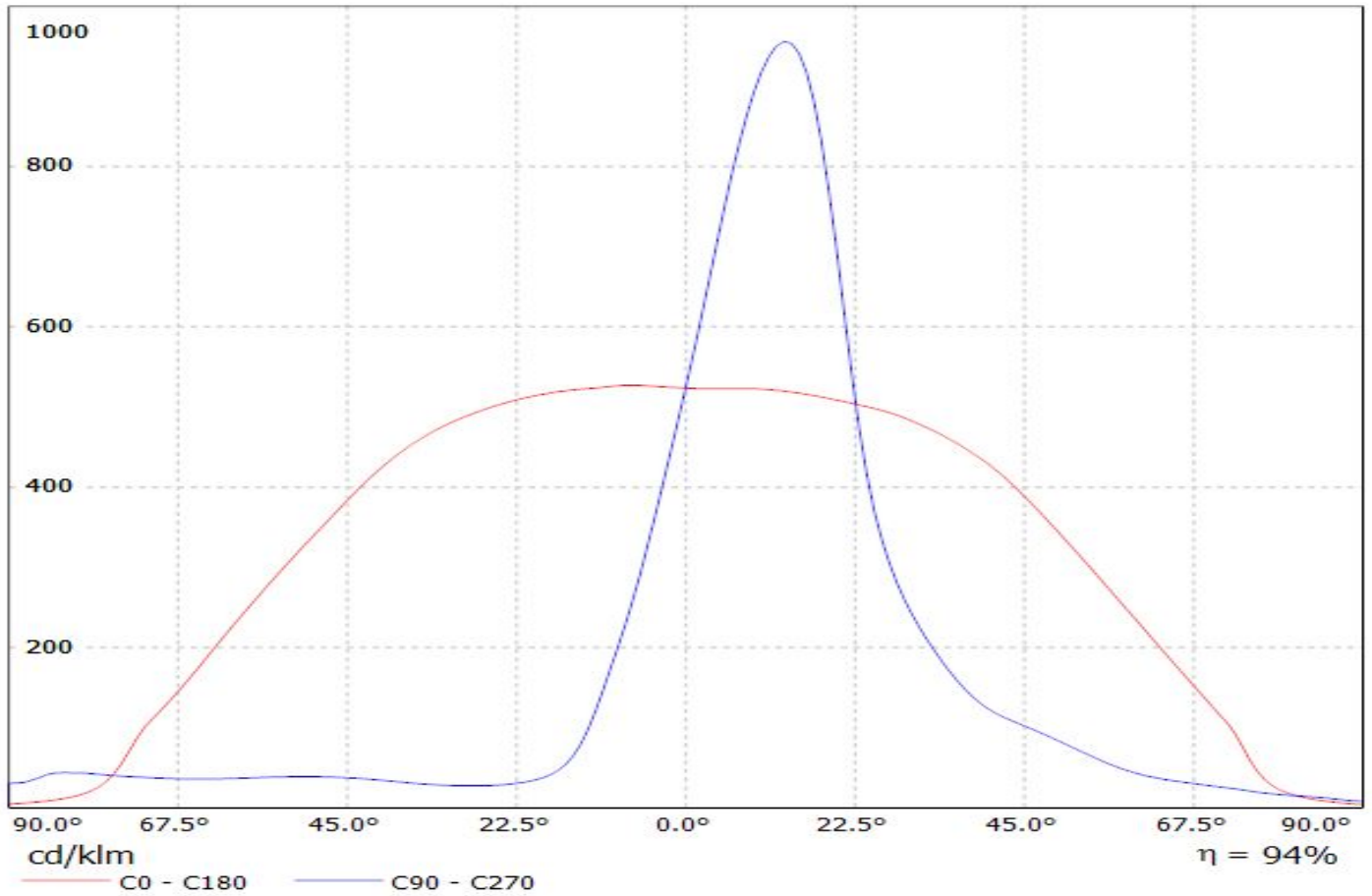

Luminaire: Ledil C14274_SHELLY-T-6X1-WAS_(Luxeon_Z_ES)

Lamps: 1 x Luxeon_Z_ES_(LXZ2-4080-3)_534.9462lm@250mA_P=4.3941W_I=0.250A

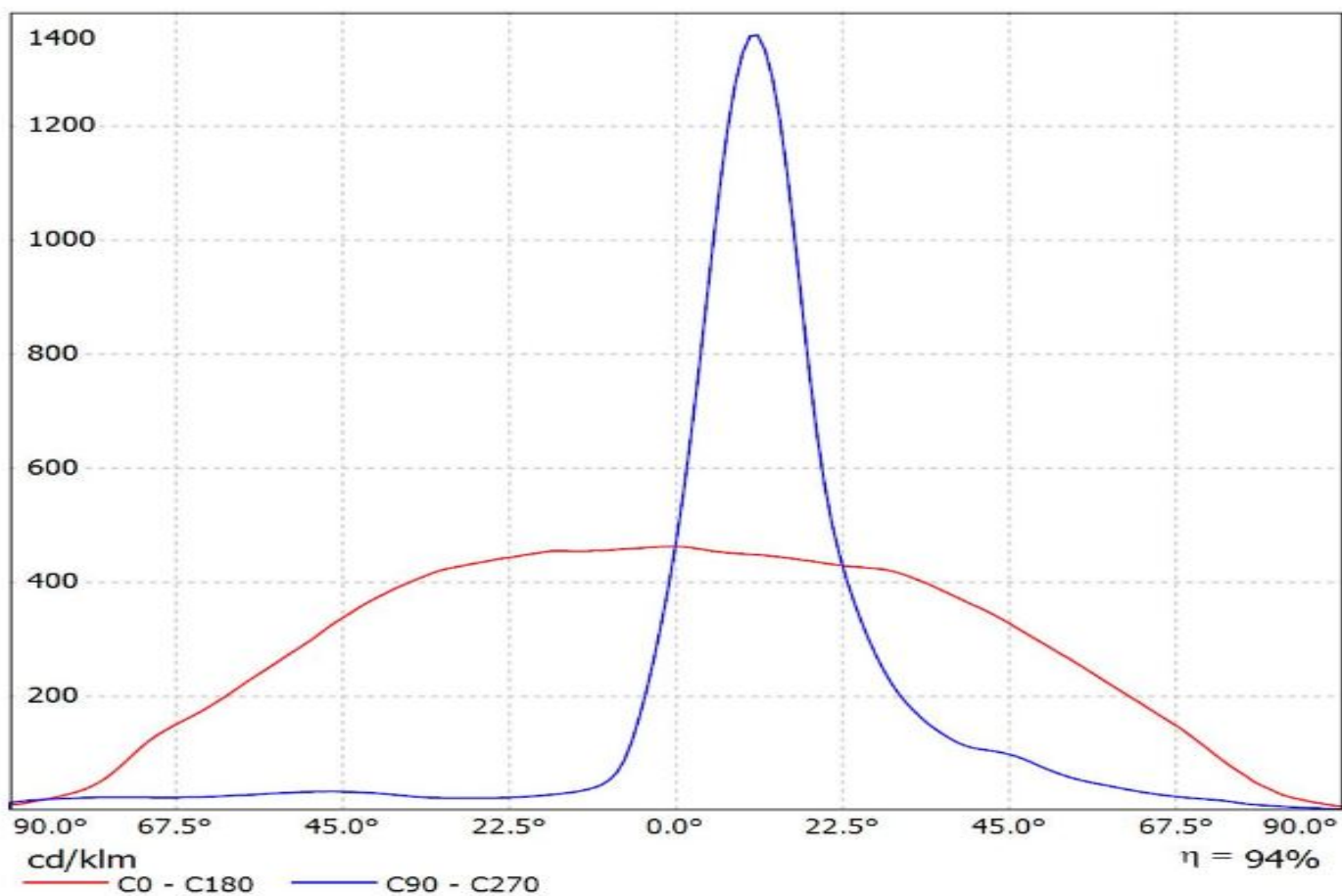

Luminaire: LEDiL Oy C14274_SHELLY-T-6X1-WAS_(REBEL_ES)

Lamps: 1 x LUXEON_REBEL_ES_1x6_512.943lm@250mA_P=4.33102W_I=249.9mA

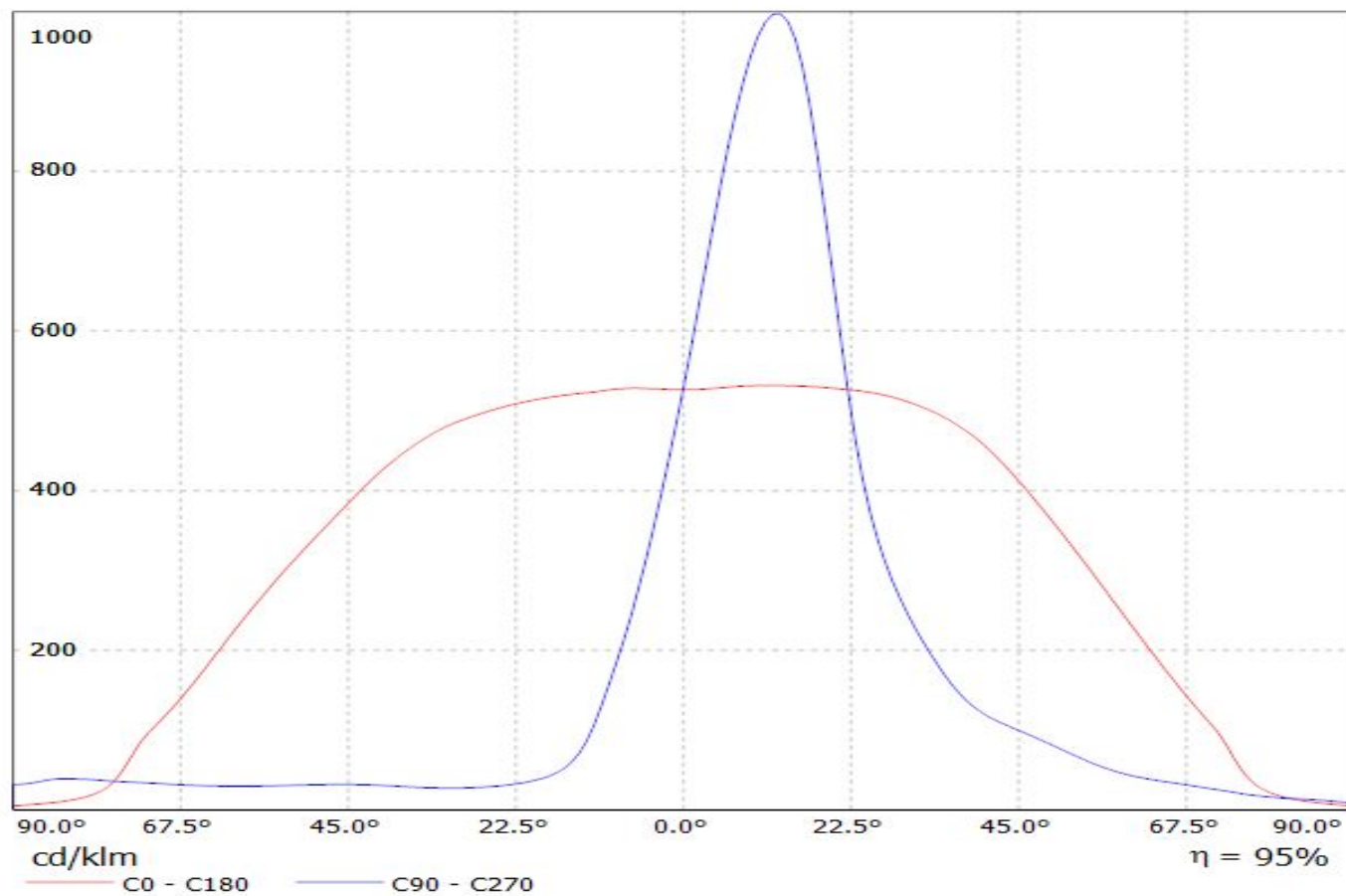

Luminaire: LEDiL Oy C14274_SHELLY-T-6X1-WAS_(Luxeon_TX)

Lamps: 1 x Luxeon_TX_6x1_(L1T2-5770)_652.342lm@250mA_CCT=5700K_P=4.18365W_I=249.8mA

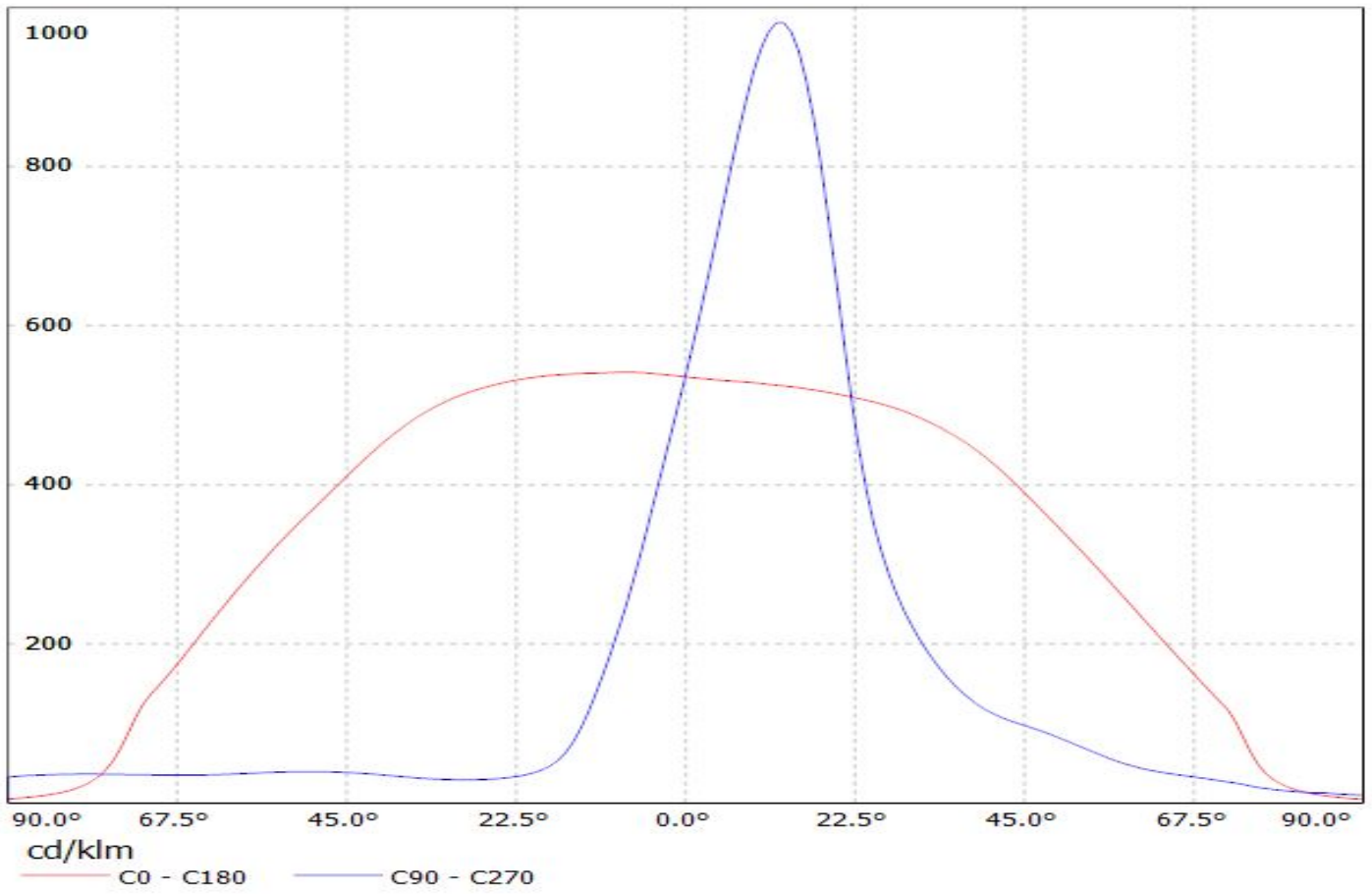

Luminaire: LEDiL Oy C14274_SHELLY-T-6X1-WAS_(NF2x757A)
Lamps: 1 x Nichia_NF2x757A_6x1_405.289lm@100mA_P=3.58939W_I=100.1mA

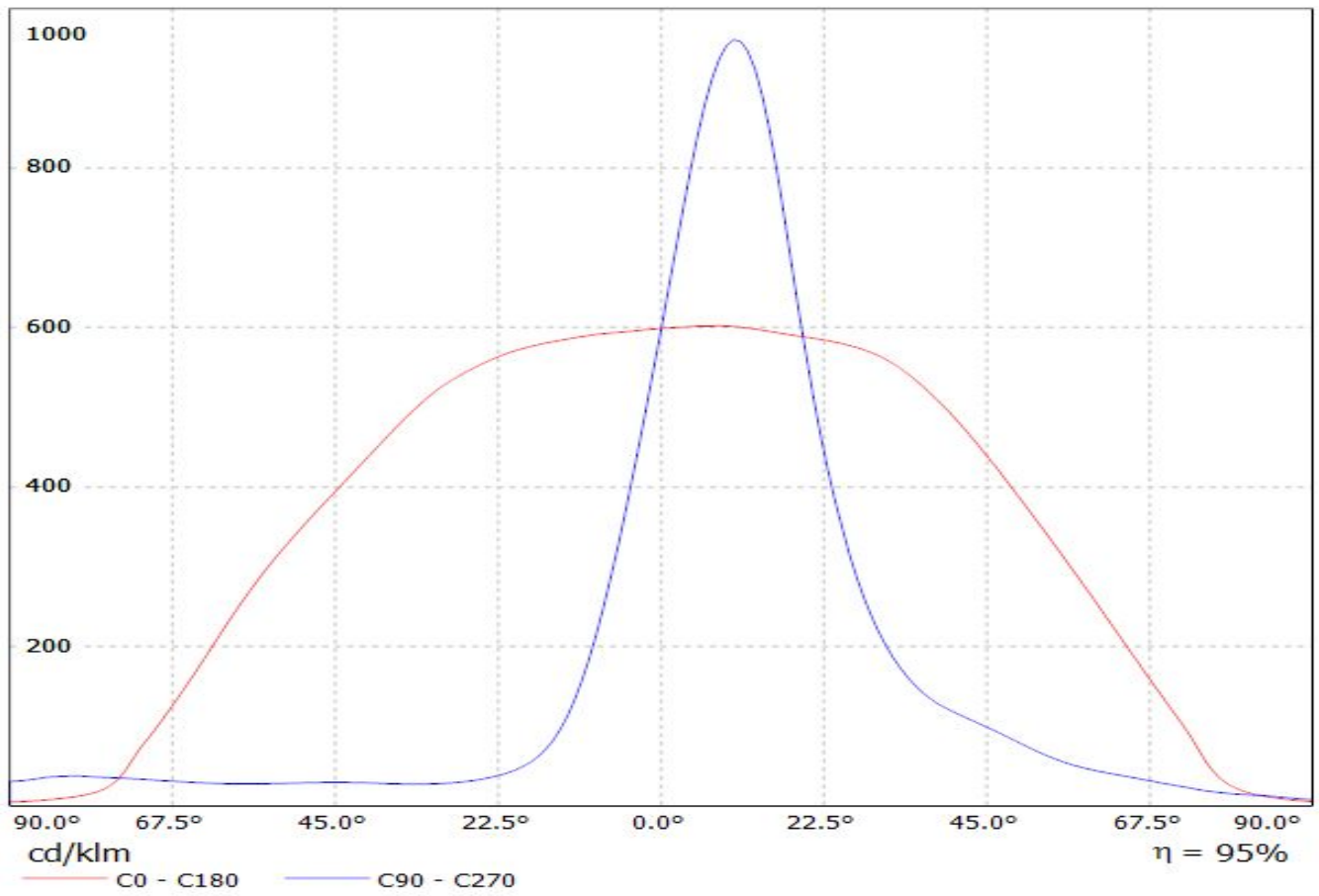

Luminaire: LEDiL Oy C14274_SHELLY-T-6X1-WAS_(NCS19A)_1 Eff.94.3%
Lamps: 1 x NICHIA_NCS19A_1x6_531.294lm@250mA_P=4.61215W_I=249.9mA

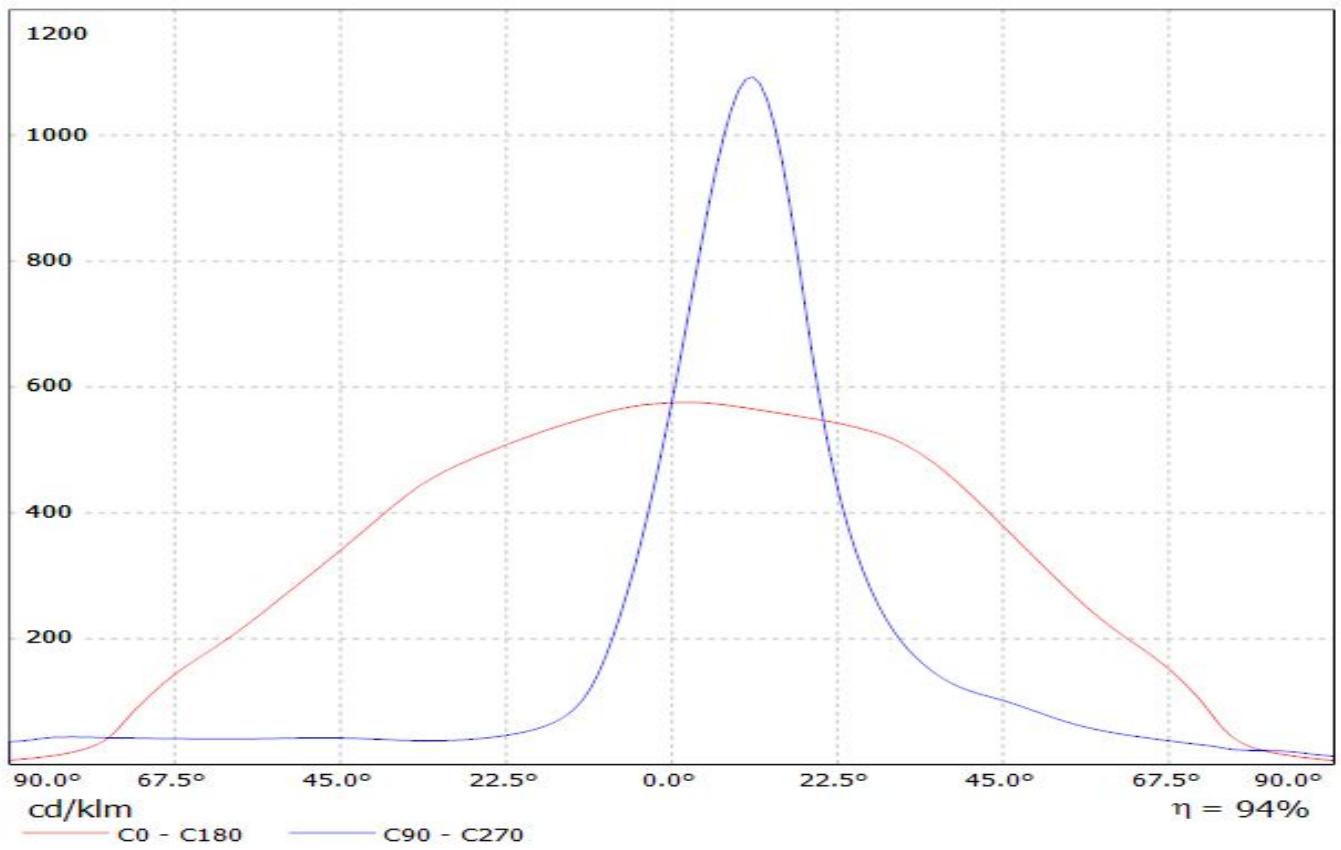

Luminaire: LEDiL Oy C14274_SHELLY-T-6X1-WAS_(NVSxx19A) Eff.94.0%
Lamps: 1 x NVSxx19A_1x6_584.6lm@250mA_P=4.379W_I=249.9mA

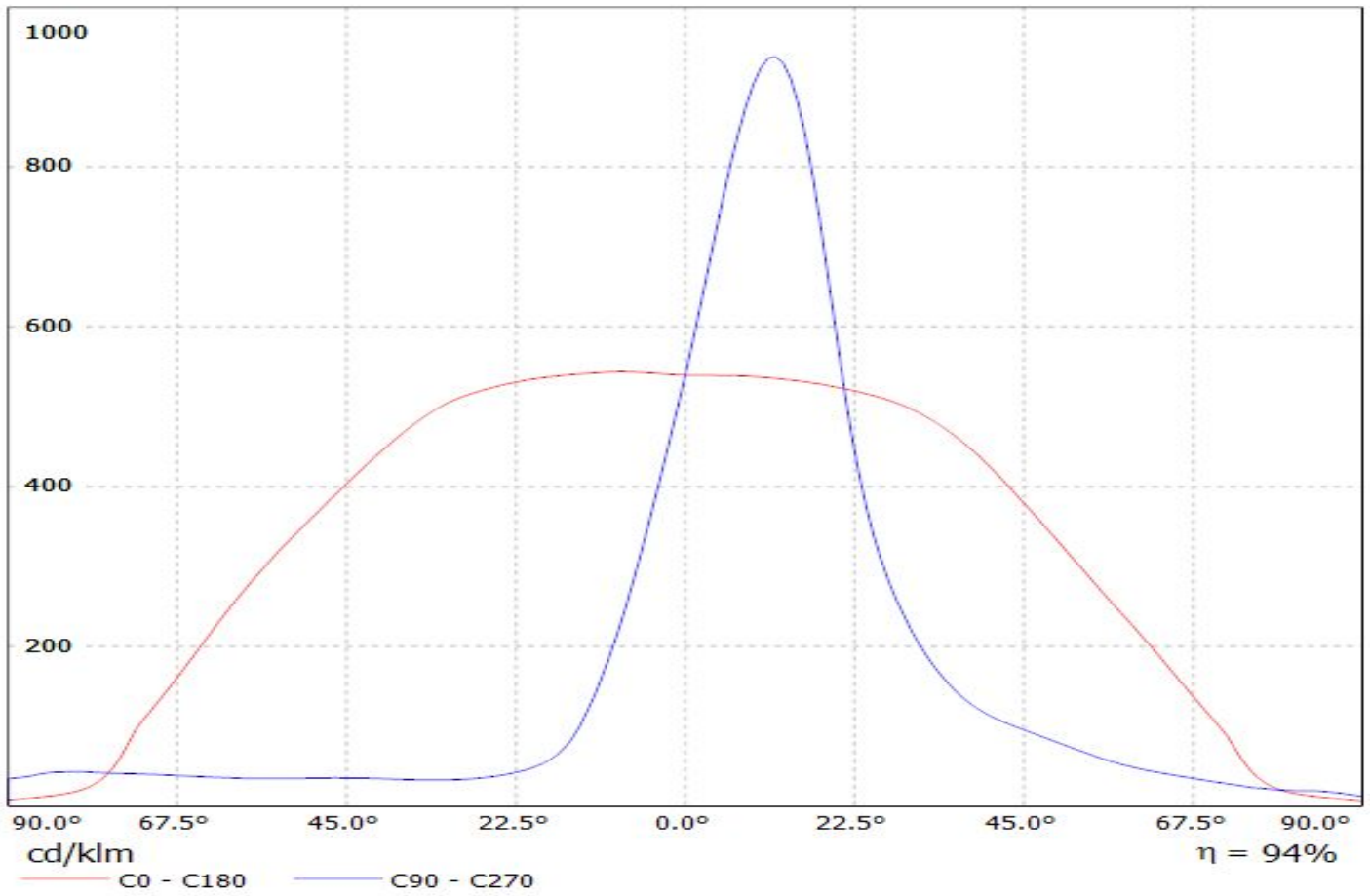

Luminaire: LEDiL Oy C14274_SHELLY-T-6X1-WAS_(NCSxx19B)
Lamps: 1 x NCSxx19B_1x6_631.5lm@250mA_P=4.18008W_I=249.9mA

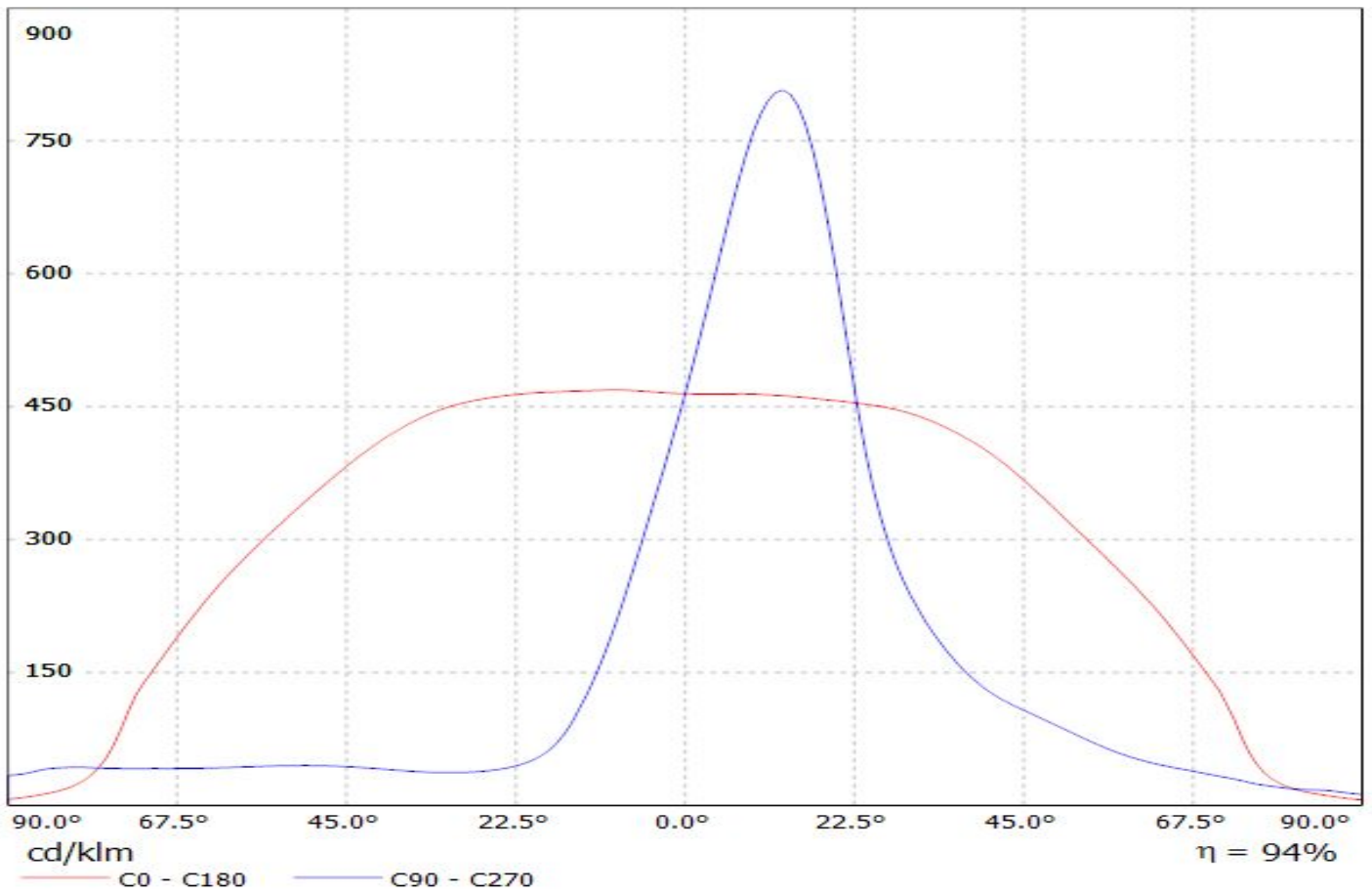

Luminaire: LEDiL Oy C14274_SHELLY-T-6X1-WAS_(NVSxx19B)
Lamps: 1 x NVSxx19B_1x6_459.756lm@250mA_P=4.21581W_I=249.9mA

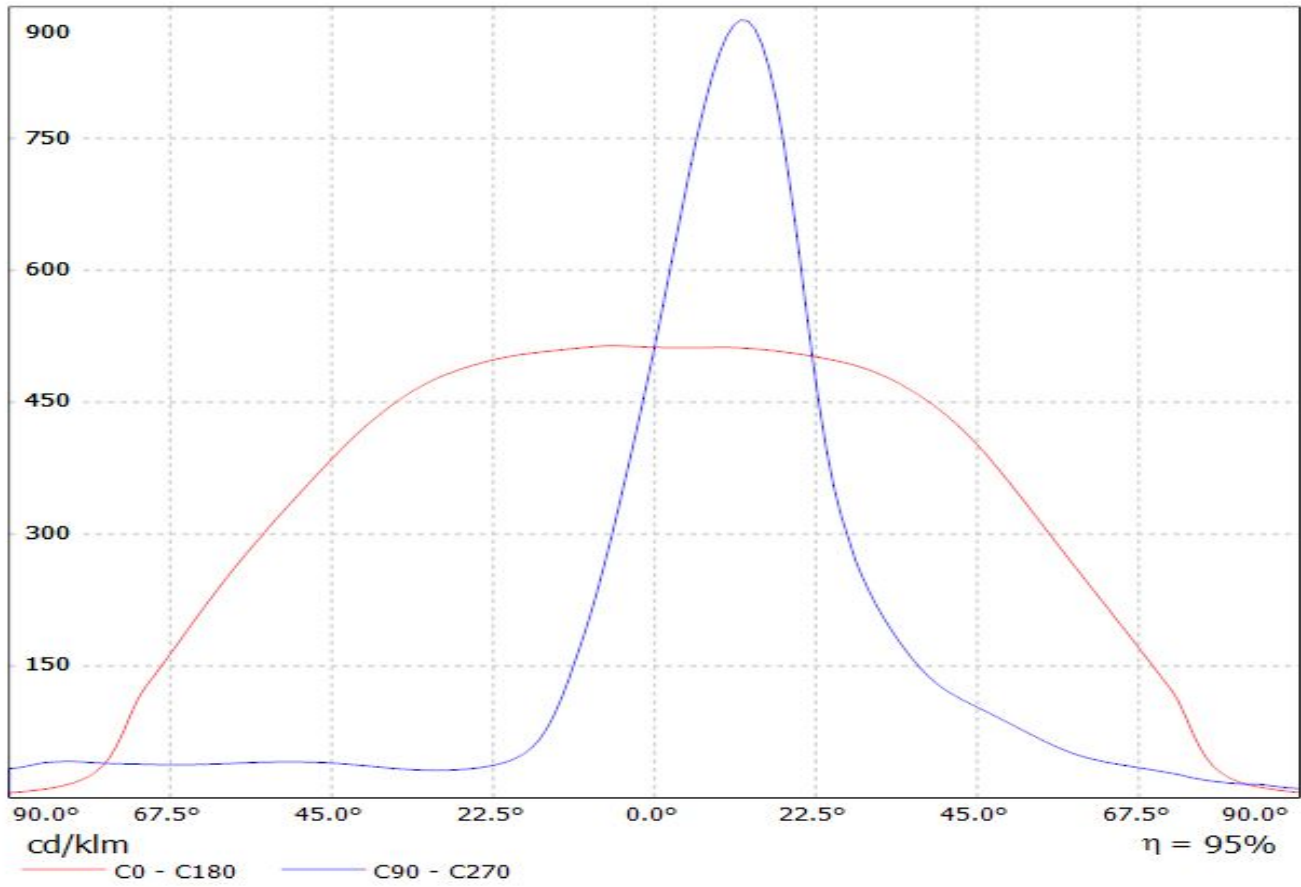

Luminaire: Ledil C14274_SHELLY-T-6X1-WAS (Duris_S5_2_chip)
Lamps: 1 x Osram_Duris_S5_2_chip_(PSLRS1EC-LQLS-5H7I-1)
_756.726lm@150mA_P=5.6W_I=0.150A

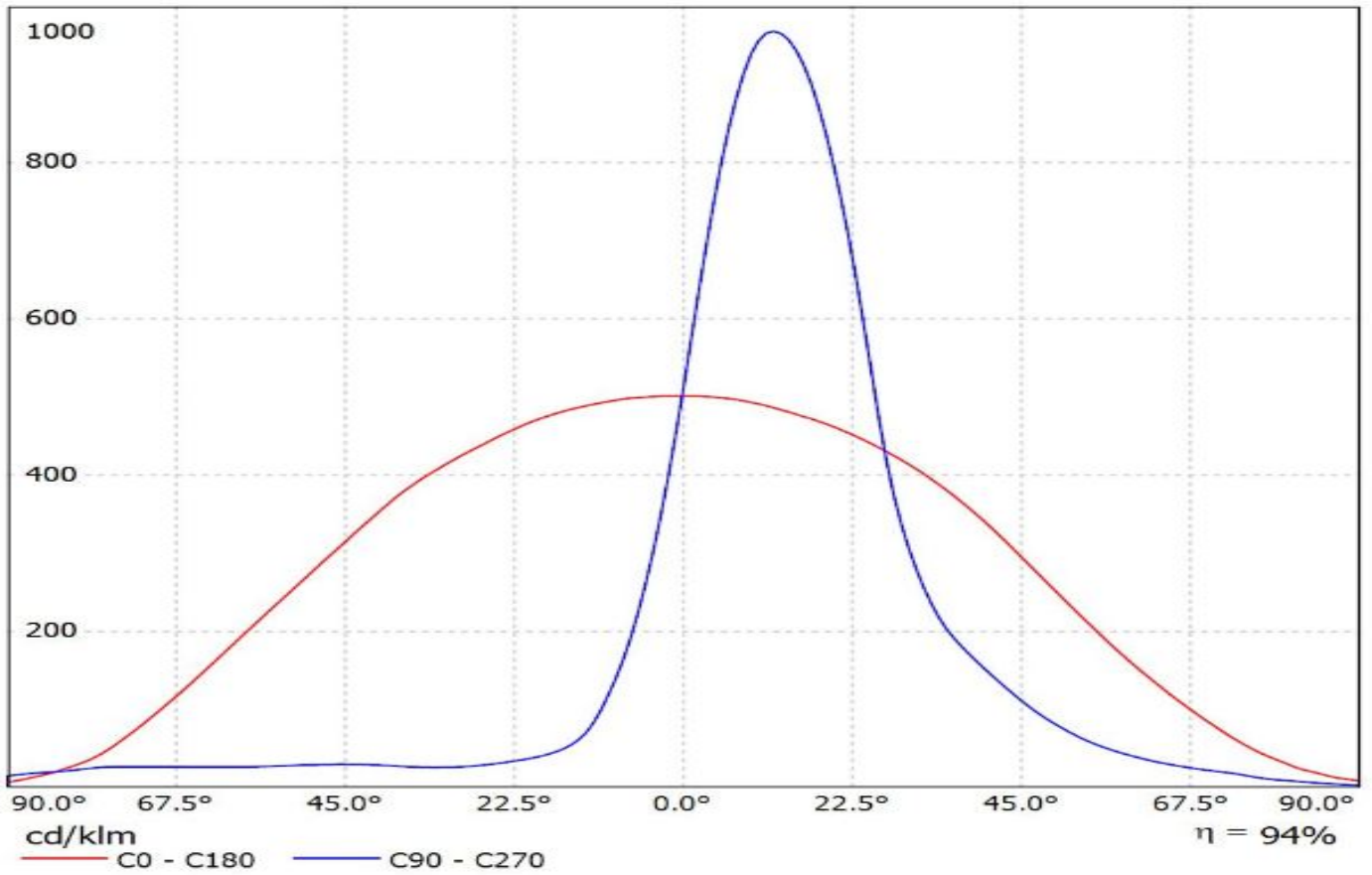

Luminaire: Ledil C14274_SHELLY-T-6X1-WAS_(Cree_XQ-E)

Lamps: 1 x Cree_XQ-E_(XQEAWT-0-7B1-Q40-0H-00001)_497.31lm@250mA_P=4.5957W_I=0.250A

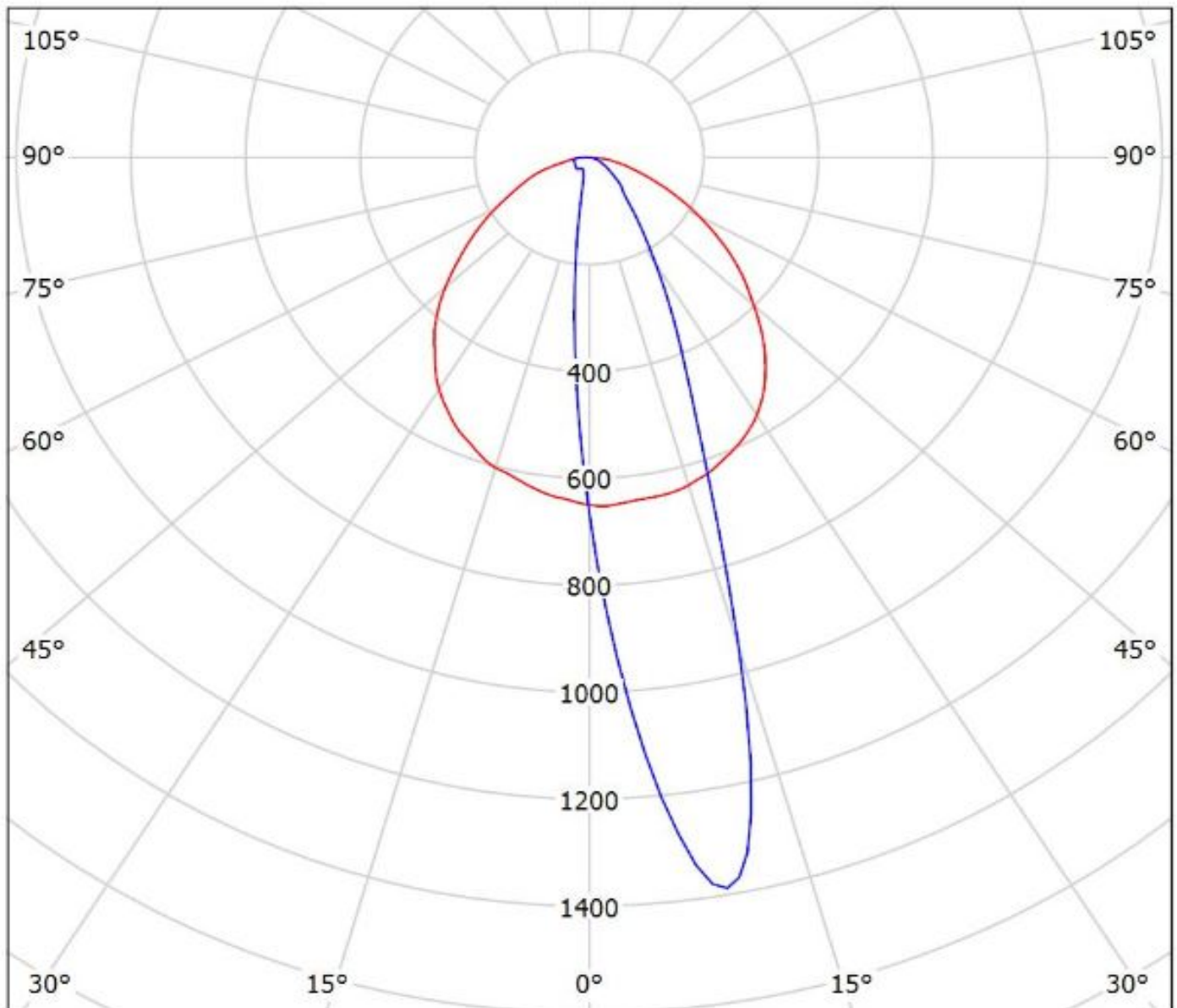

cd/klm

— C0 - C180 — C90 - C270

$\eta = 94\%$

Luminaire: LEDiL Oy C14274_SHELLY-T-6X1-WAS_(LUXEON_T)

Lamps: 1 x LUXEON_T_1x6_(LXH8-FW30-3)_438.8lm@250mA_P=4.17608W_I=249.9mA

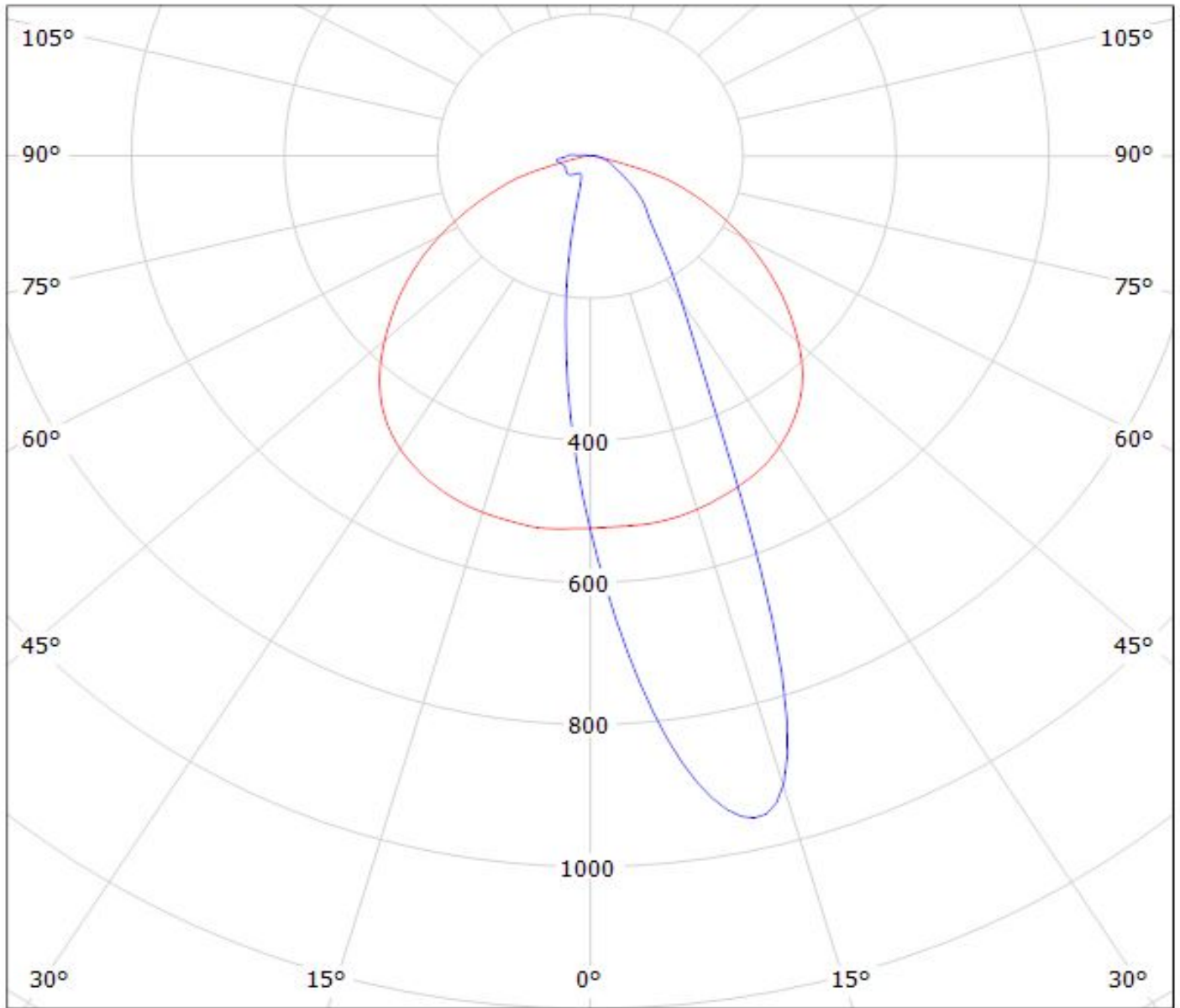

cd/klm

— C0 - C180 — C90 - C270

$\eta = 94\%$

Luminaire: Ledil C14274_SHELLY-T-6X1-WAS_(Luxeon_Z_ES)

Lamps: 1 x Luxeon_Z_ES_(LXZ2-4080-3)_534.9462lm@250mA_P=4.3941W_I=0.250A

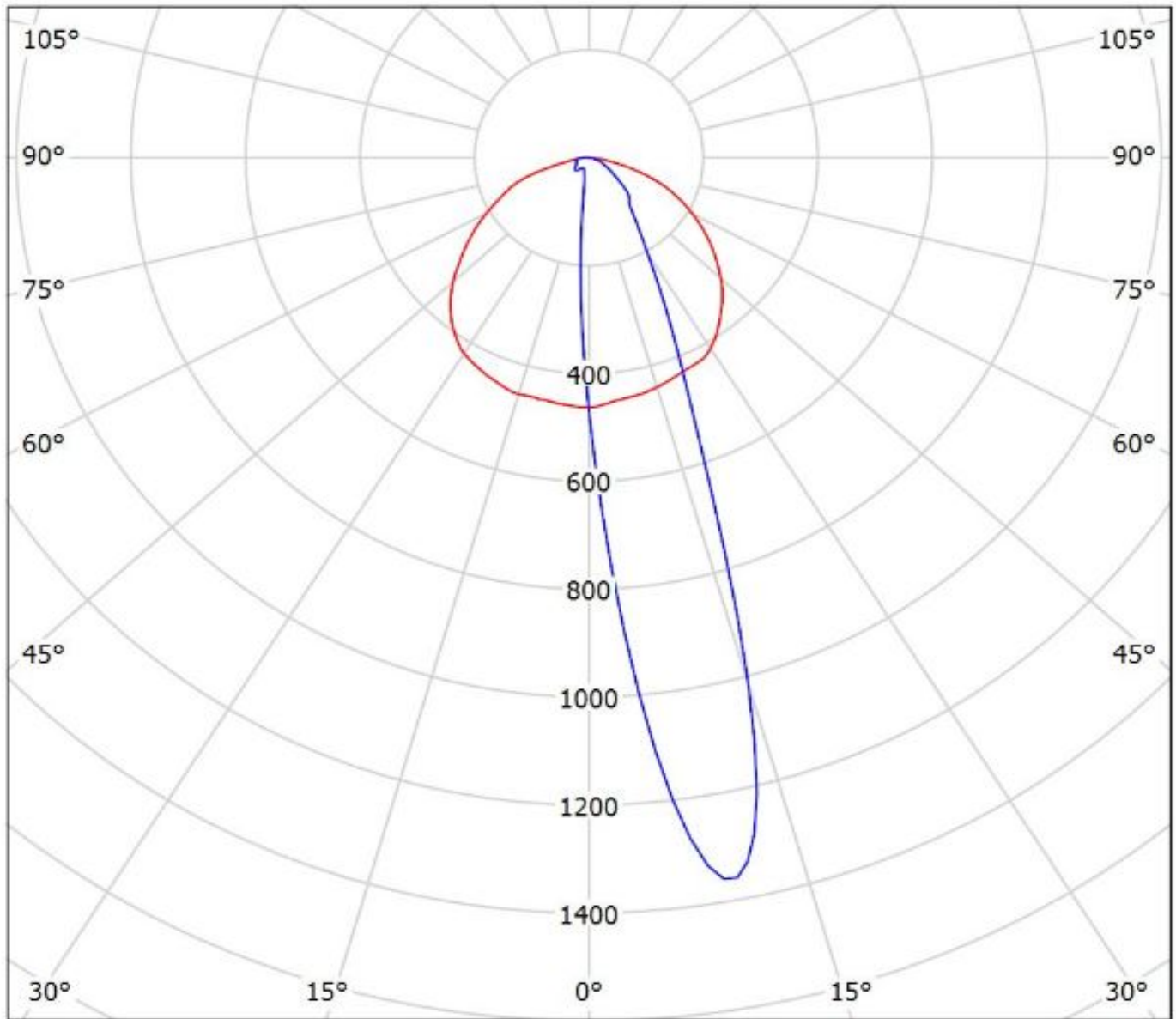

cd/klm

— C0 - C180 — C90 - C270

$\eta = 94\%$

Luminaire: LEDiL Oy C14274_SHELLY-T-6X1-WAS_(REBEL_ES)
Lamps: 1 x LUXEON_REBEL_ES_1x6_512.943lm@250mA_P=4.33102W_I=249.9mA

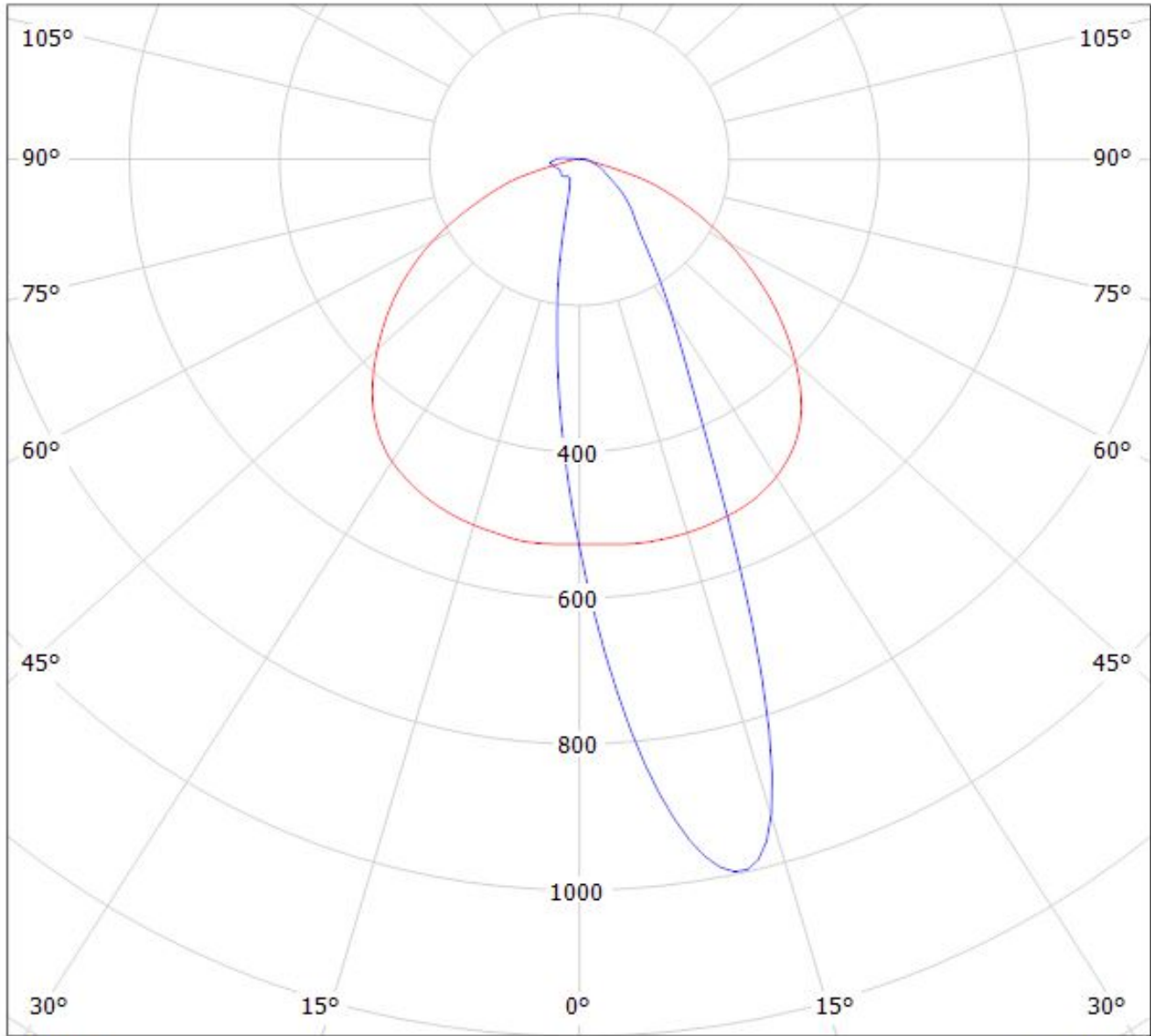

cd/klm

— C0 - C180 — C90 - C270

$\eta = 95\%$

Luminaire: LEDiL Oy C14274_SHELLY-T-6X1-WAS_(Luxeon_TX)

Lamps: 1 x Luxeon_TX_6x1_(L1T2-5770)_652.342lm@250mA_CCT=5700K_P=4.18365W_I=249.8mA

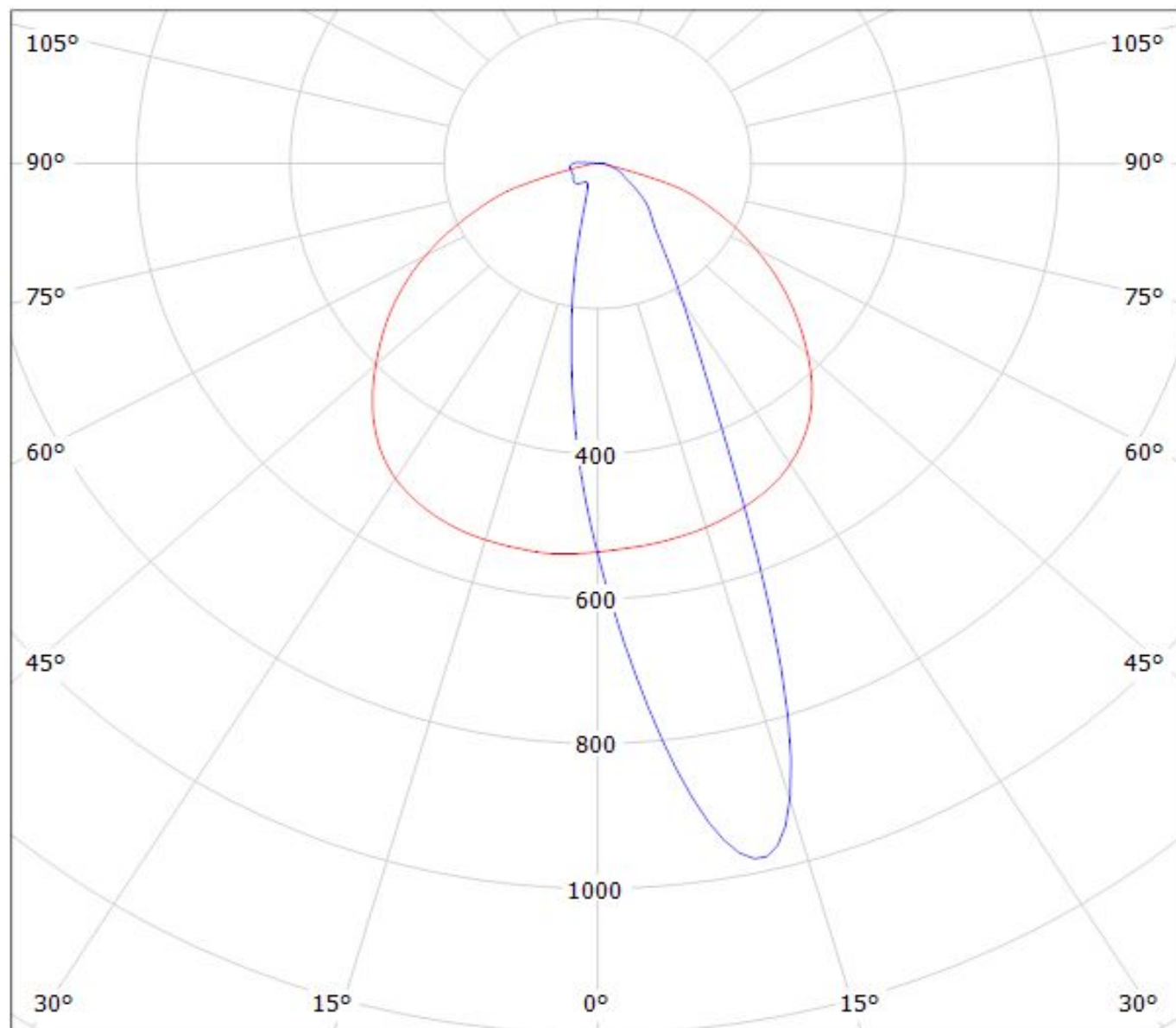

cd/klm

— C0 - C180

— C90 - C270

Luminaire: LEDiL Oy C14274_SHELLY-T-6X1-WAS_(NF2x757A)
Lamps: 1 x Nichia_NF2x757A_6x1_405.289lm@100mA_P=3.58939W_I=100.1mA

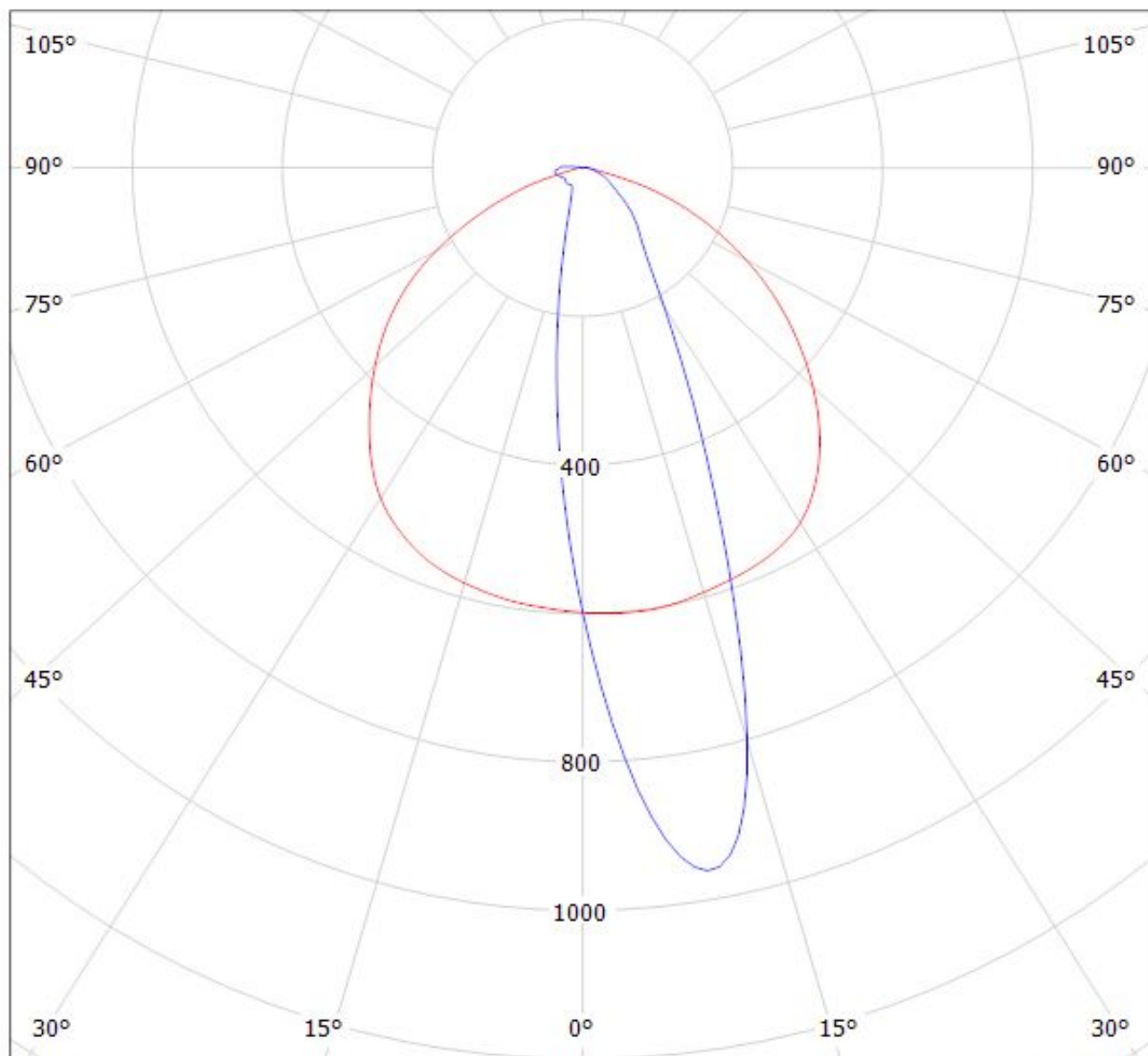

cd/klm

$\eta = 95\%$

— C0 - C180

— C90 - C270

Luminaire: LEDiL Oy C14274_SHELLY-T-6X1-WAS_(NCS19A)_1 Eff.94.3%
Lamps: 1 x NICHIA_NCS19A_1x6_531.294lm@250mA_P=4.61215W_I=249.9mA

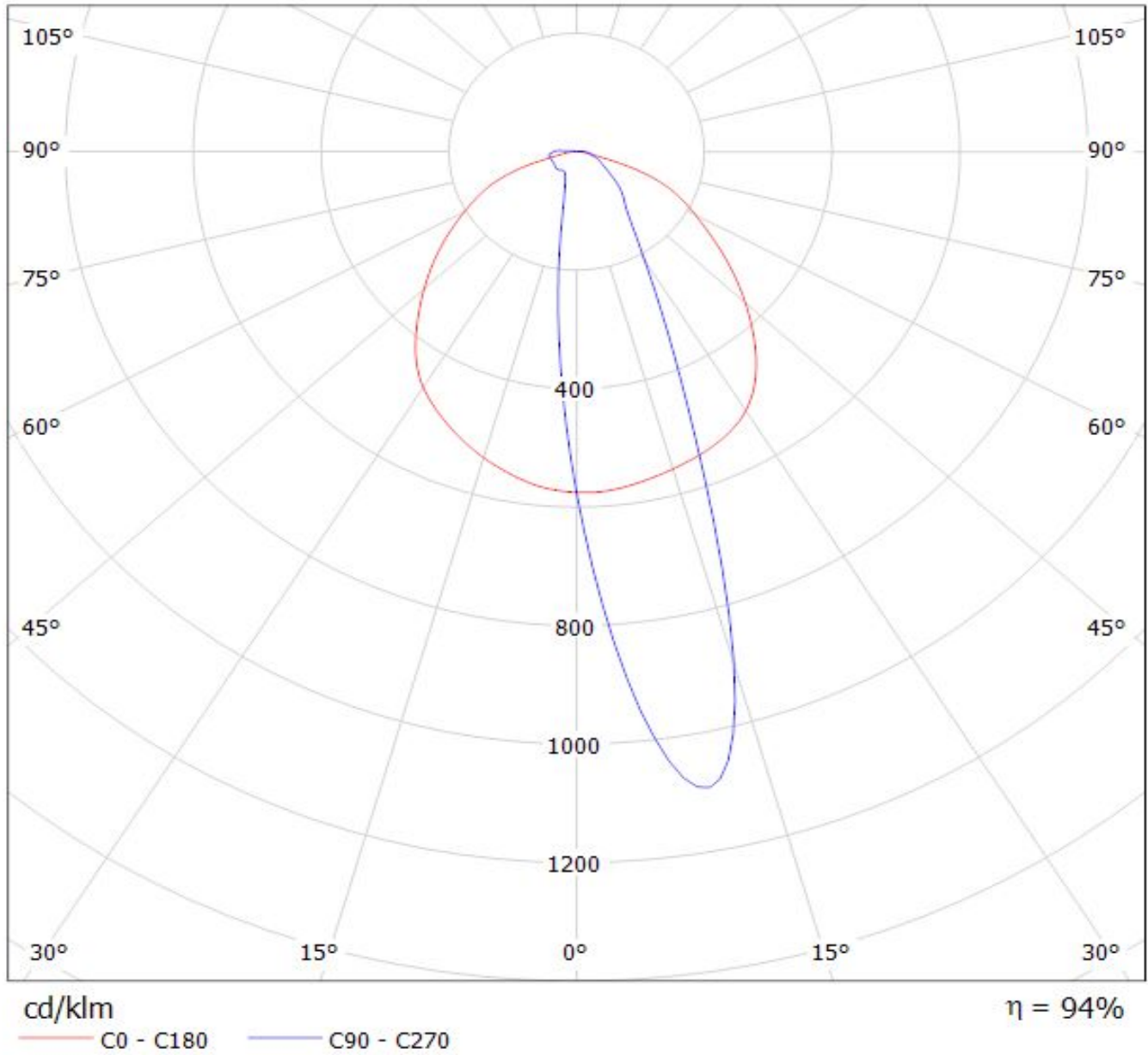

Luminaire: LEDiL Oy C14274_SHELLY-T-6X1-WAS_(NVSxx19A) Eff.94.0%
Lamps: 1 x NVSxx19A_1x6_584.6lm@250mA_P=4.379W_I=249.9mA

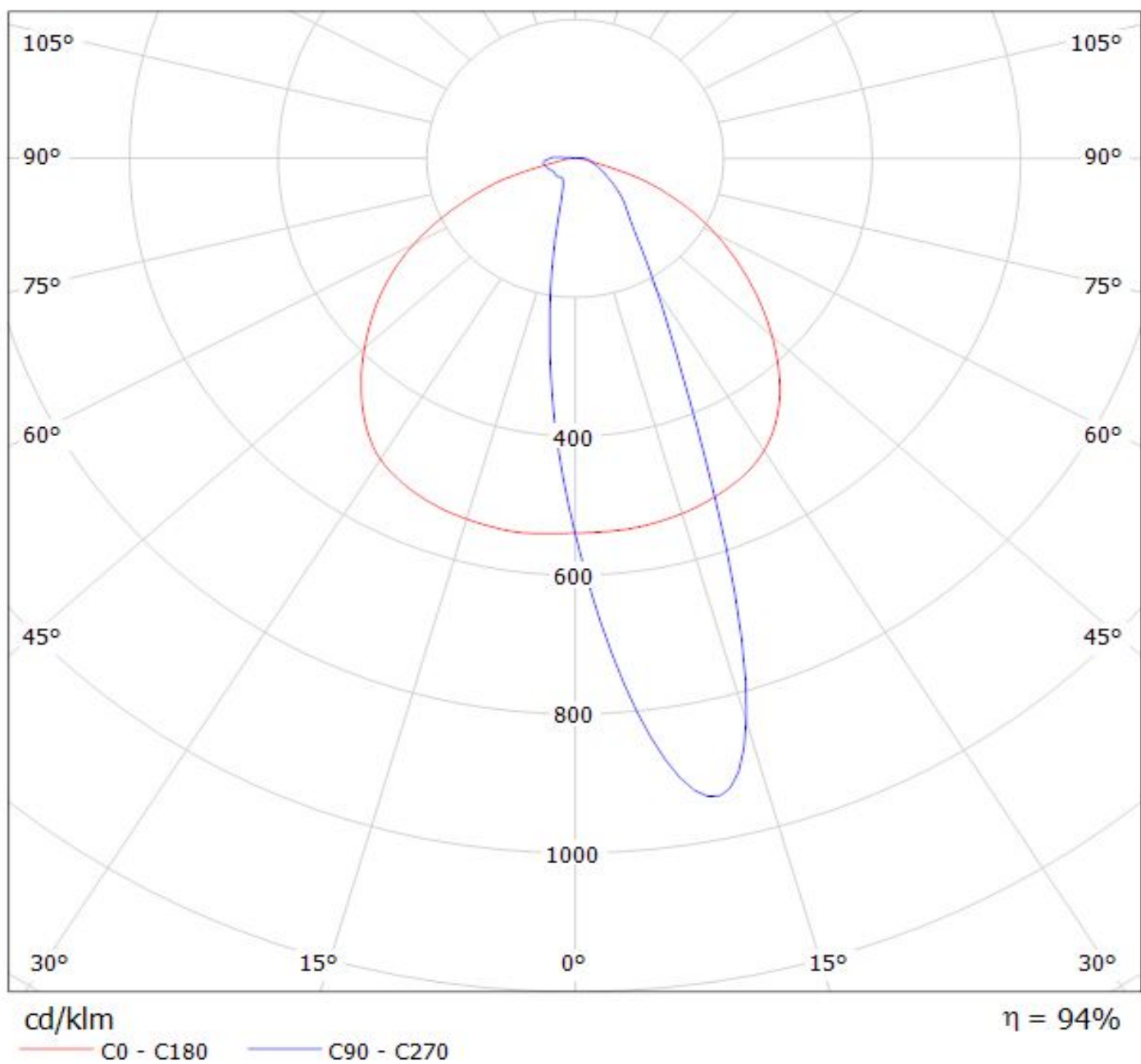

Luminaire: LEDiL Oy C14274_SHELLY-T-6X1-WAS_(NCSxx19B)
Lamps: 1 x NCSxx19B_1x6_631.5lm@250mA_P=4.18008W_I=249.9mA

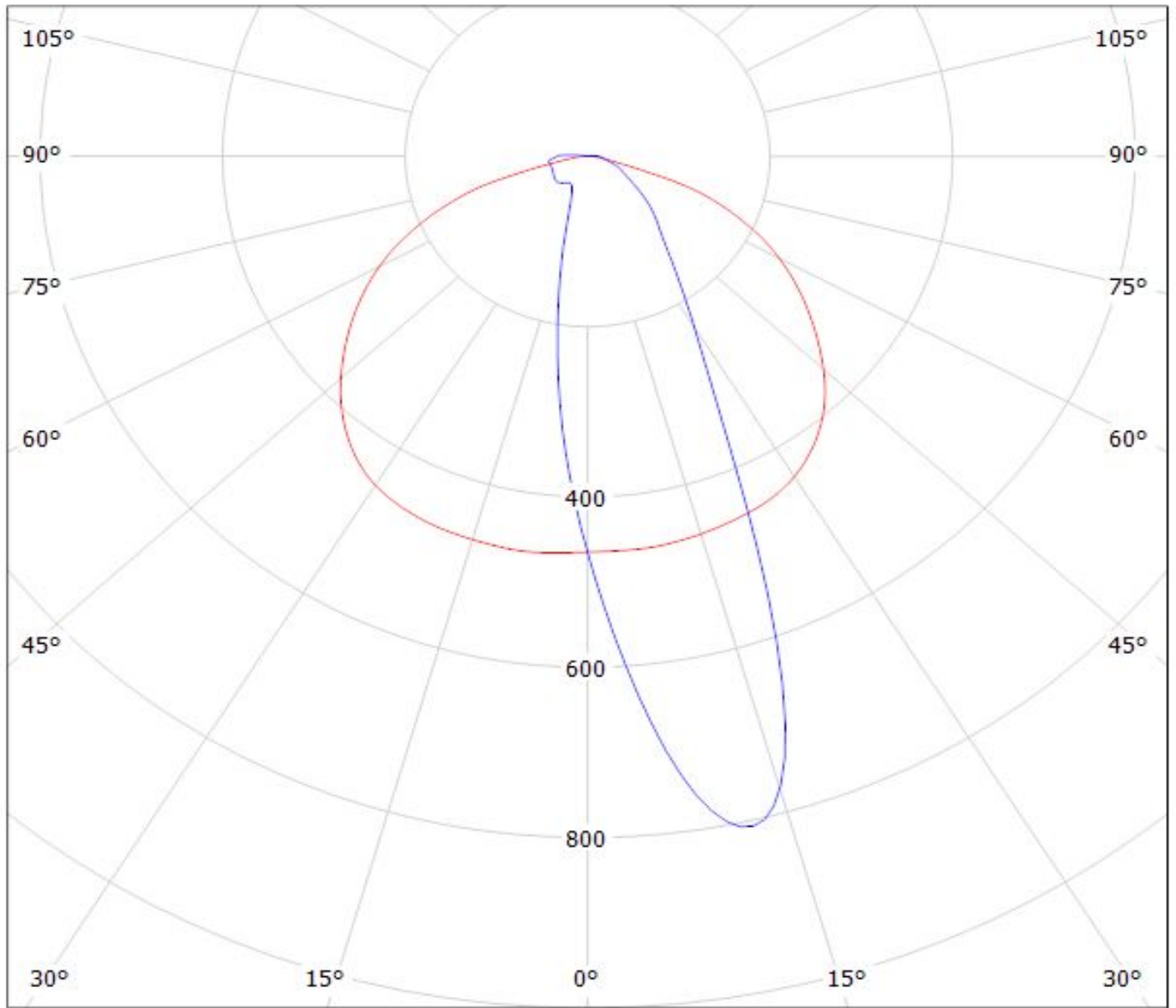

cd/klm

— C0 - C180 — C90 - C270

$\eta = 94\%$

Luminaire: LEDiL Oy C14274_SHELLY-T-6X1-WAS_(NVSxx19B)
Lamps: 1 x NVSxx19B_1x6_459.756lm@250mA_P=4.21581W_η=249.9mA

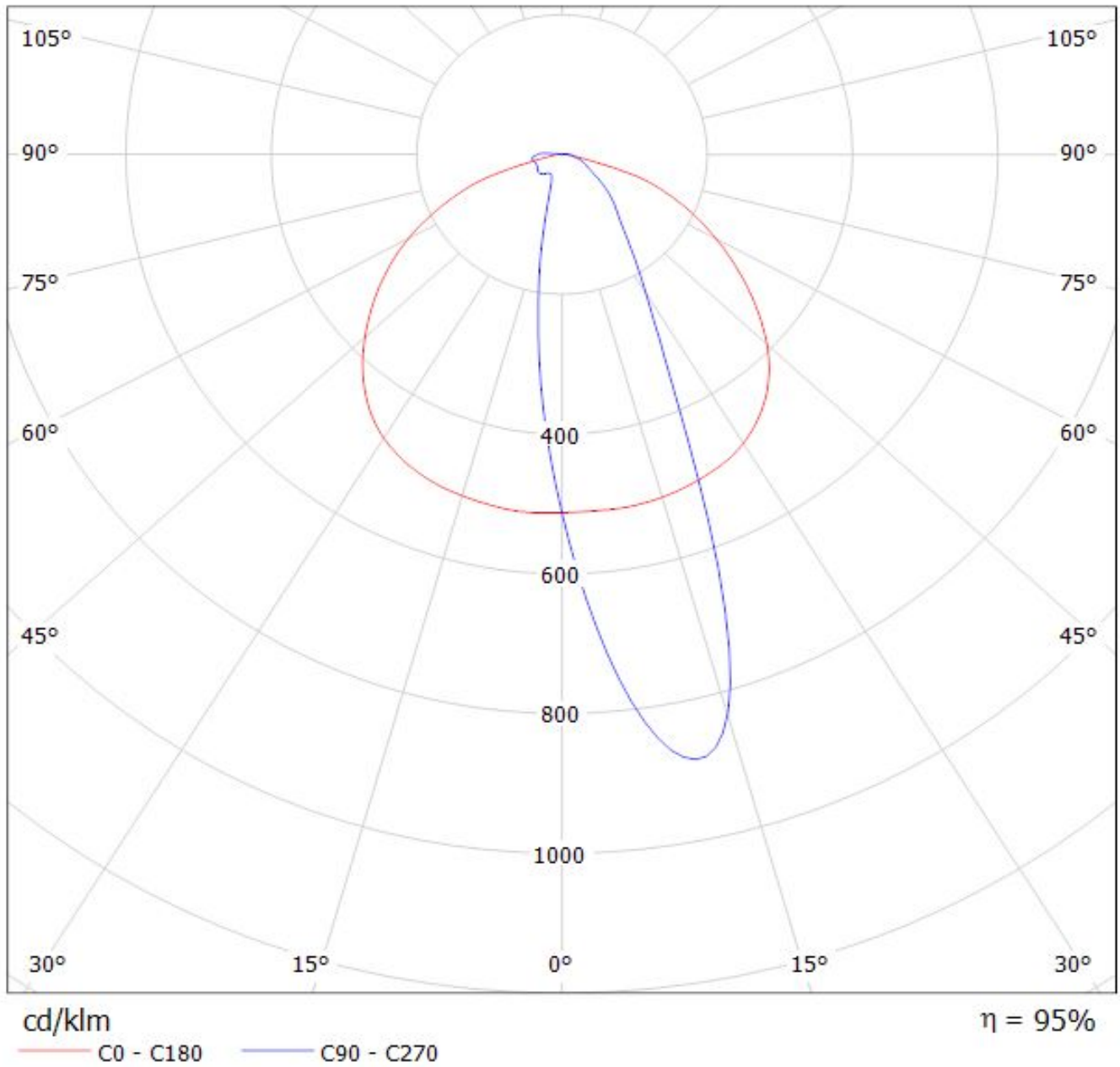

Luminaire: Ledil C14274_SHELLY-T-6X1-WAS_(Duris_S5_(2_chip))
Lamps: 1 x Osram_Duris_S5_(2_chip)_(PSLRS1EC-LQLS-5H7I-1)
_756.726lm@150mA_P=5.6W_I=0.150A

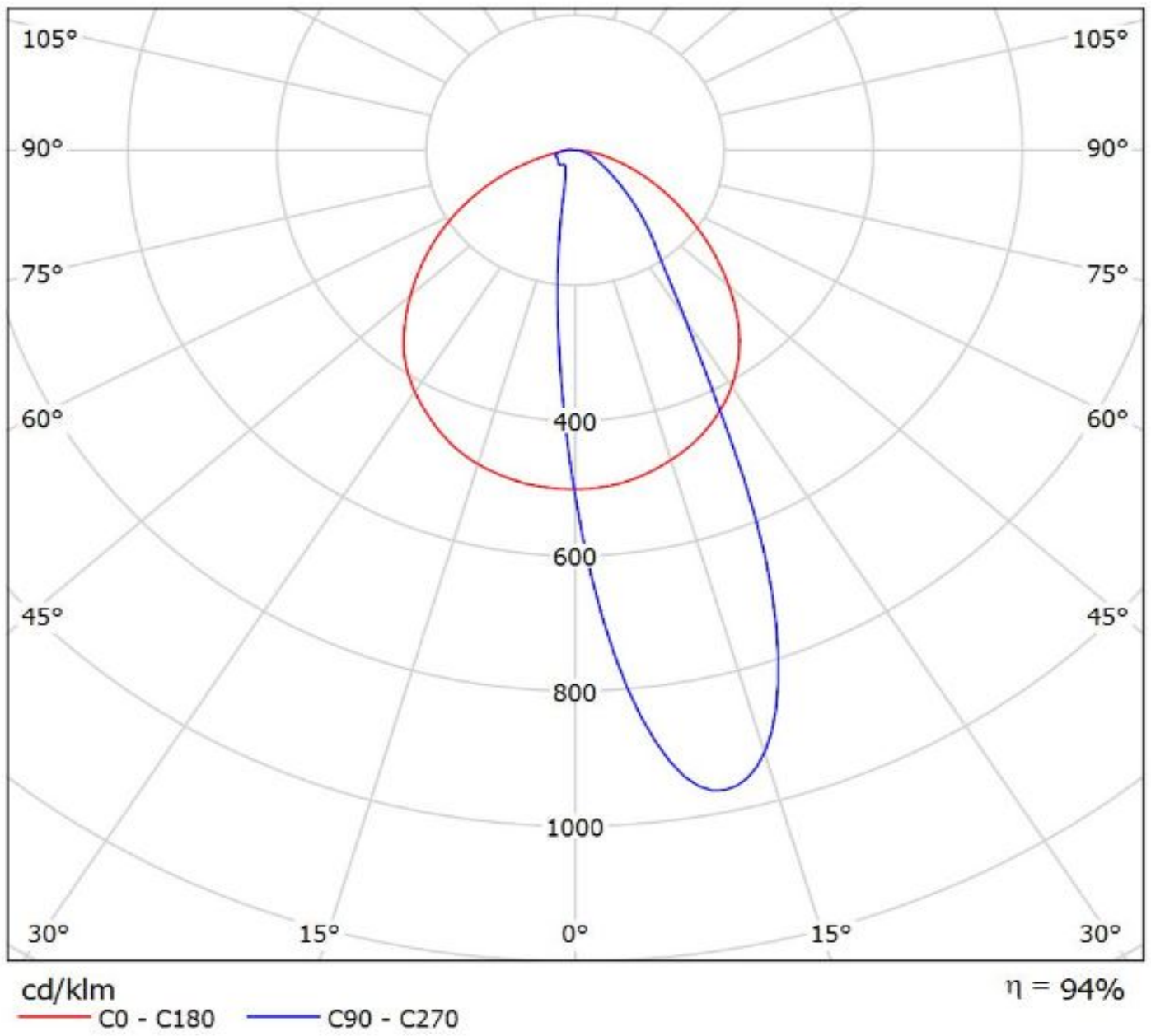

NOTE: The typical divergence will be changed by different color, chip size and chip position tolerance. The typical total divergence is the full angle measured where the luminous intensity is half of the peak value.