

DETAILS

Product Number	CA11998_EMILY-SS-WAS
Family	Emily
Type	Assembly
Color	clear
Diameter	26 mm
Height	14,8 mm
Style	round
Optic Material	PMMA
Holder Material	
Fastening	tape, pin
Status	production ready
ROHS Compliant	Yes
Date Updated	9/06/2016

OPTICAL PROPERTIES

LED	Viewing Angle	Light Beam	Efficiency	cd/lm	Connector
XP-E	10 deg	Asymmetric	92 %	18.300	-
XP-G	11 deg	Asymmetric	93 %	11.920	-
XM-L	13 deg	Asymmetric	92 %	-	-
XM-L2	asymmetric deg	Asymmetric	88 %	10.500	-
XP-L HI	asymmetric deg	Asymmetric	91 %	14.600	-
LUXEON Rebel	8 deg	Asymmetric	88 %	11.600	-
LUXEON Rebel ES	12 deg	Asymmetric	91 %	9.950	-
LUXEON A	12 deg	Asymmetric	-	10.280	-
LUXEON T	11 deg	Asymmetric	89 %	14.000	-
LUXEON H50-2	sim: Asymmetric	Asymmetric	-	-	-
LUXEON TX	asymmetric deg	Asymmetric	88 %	14.800	-
NVSxx19A	13 deg	Asymmetric	89 %	8.030	-
NCSxx19B	11 deg	Asymmetric	89 %	15.500	-
NVSxx19B/NVSxx19C	Asymmetric deg	Asymmetric	93 %	12.100	-
Oslon SSL 80	11 deg	Asymmetric	91 %	10.980	-
Oslon SSL 150	11 deg	Asymmetric	88 %	14.870	-
Z5M1/Z5M2	Asymmetric deg	Asymmetric	88 %	15.200	-



D

C

B

A

4

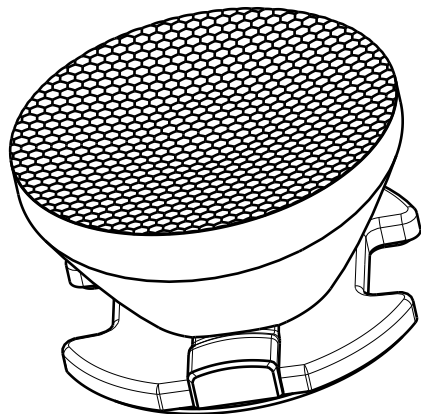

Isometric view

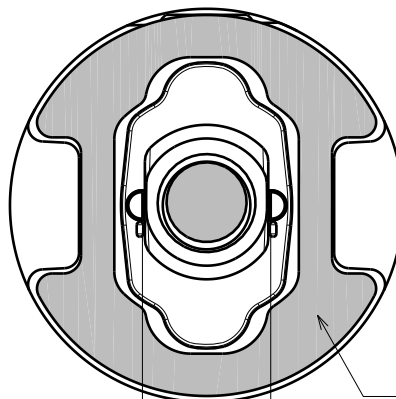

Bottom view

0.4mm tape

8.6

location pins

3

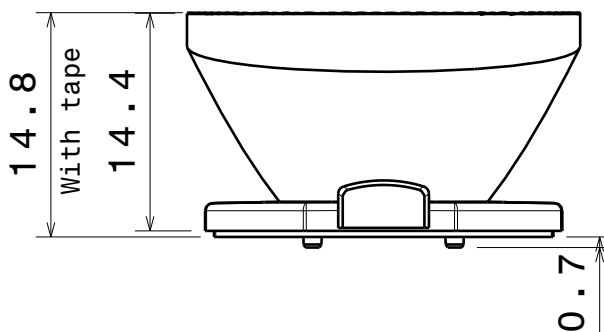

Front view

3

2

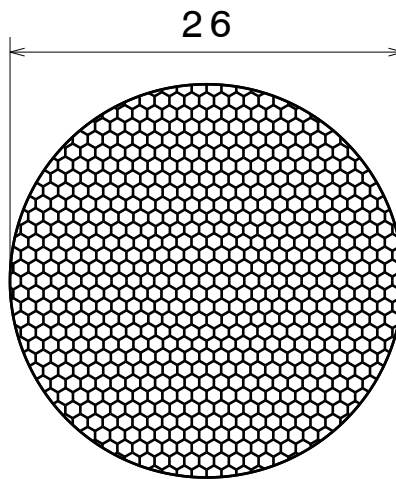

Top view

2

Part No.s:
 CA11998_EMILY-SS-WAS
 CA12000_EMILY-O-WAS
 CA12797_EMILY-O-WAS
 CA12799_EMILY-SS-WAS

Material: PMMA

This drawing is our property.
 It can't be reproduced
 or communicated without
 our written agreement.



L
T
F
F

e
e
i
i
N
n

d
h

DRAWING TITLE

Datasheet Emily-was Assembly

1

DRAWN BY

DATE

m

01.03.2011

CHECKED BY

DATE

h

h

01.03.2011

SIZE

A4

DRAWING NUMBER

REV

1

DESIGNED BY

DATE

hh

25.01.2011

SCALE

2:1

WEIGHT (g)

SHEET

1/1

D

A

Luminaire: Ledil Oy CA11998_Emily-SS-was-Tape-RE LOR=92%
Lamps: 1 x Luxeon Rebel 72lm 250mA

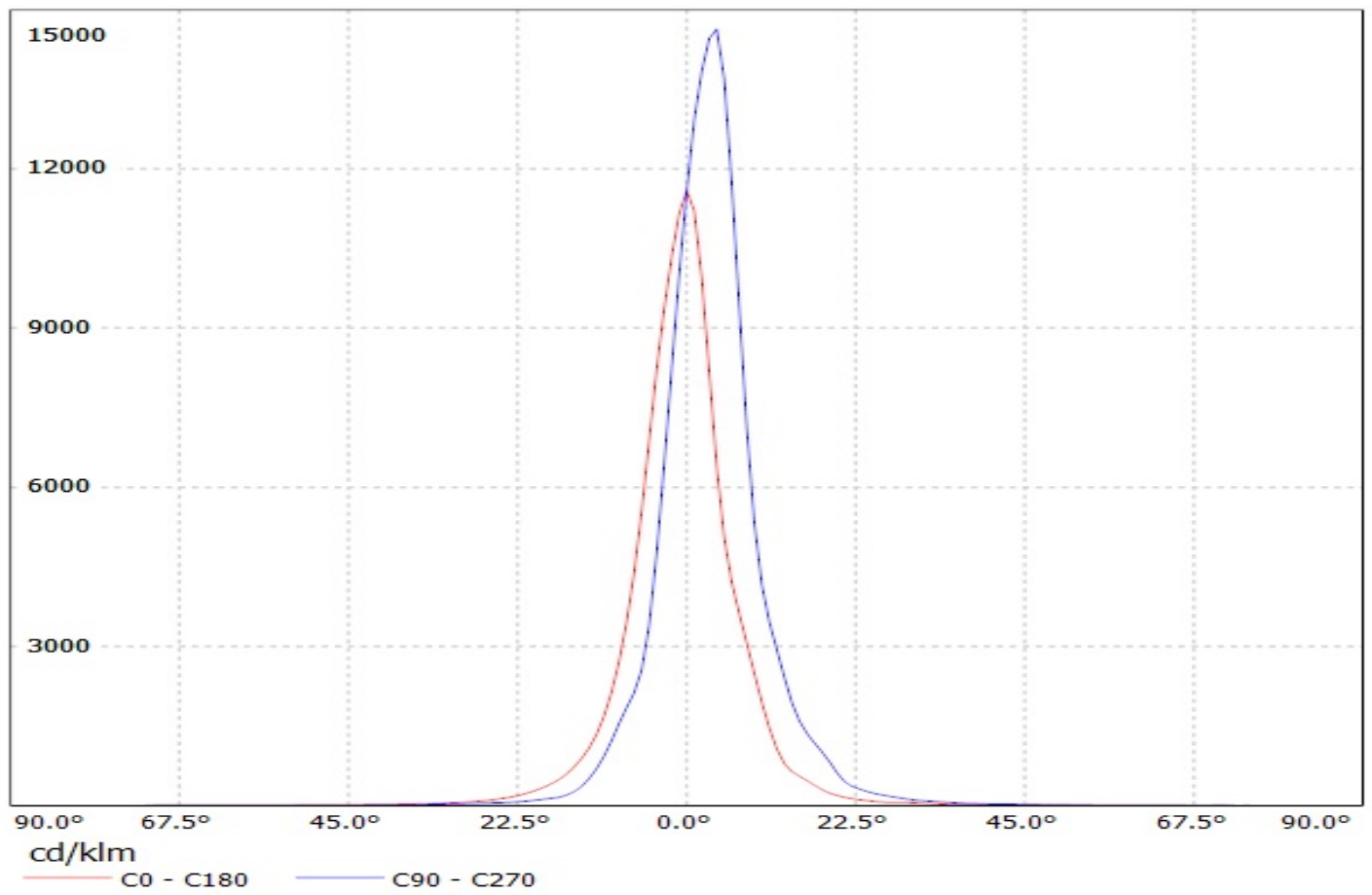

Luminaire: LEDil Oy CA11998_EMILY-SS-WAS_(XM-L2) Efficiency=88%
Lamps: 1 x Cree XM-L2 (XMLBWT-0-7B4-T30-0L-0001) 91lm @ 250mA CCT=3200K P=0.7W I=250mA

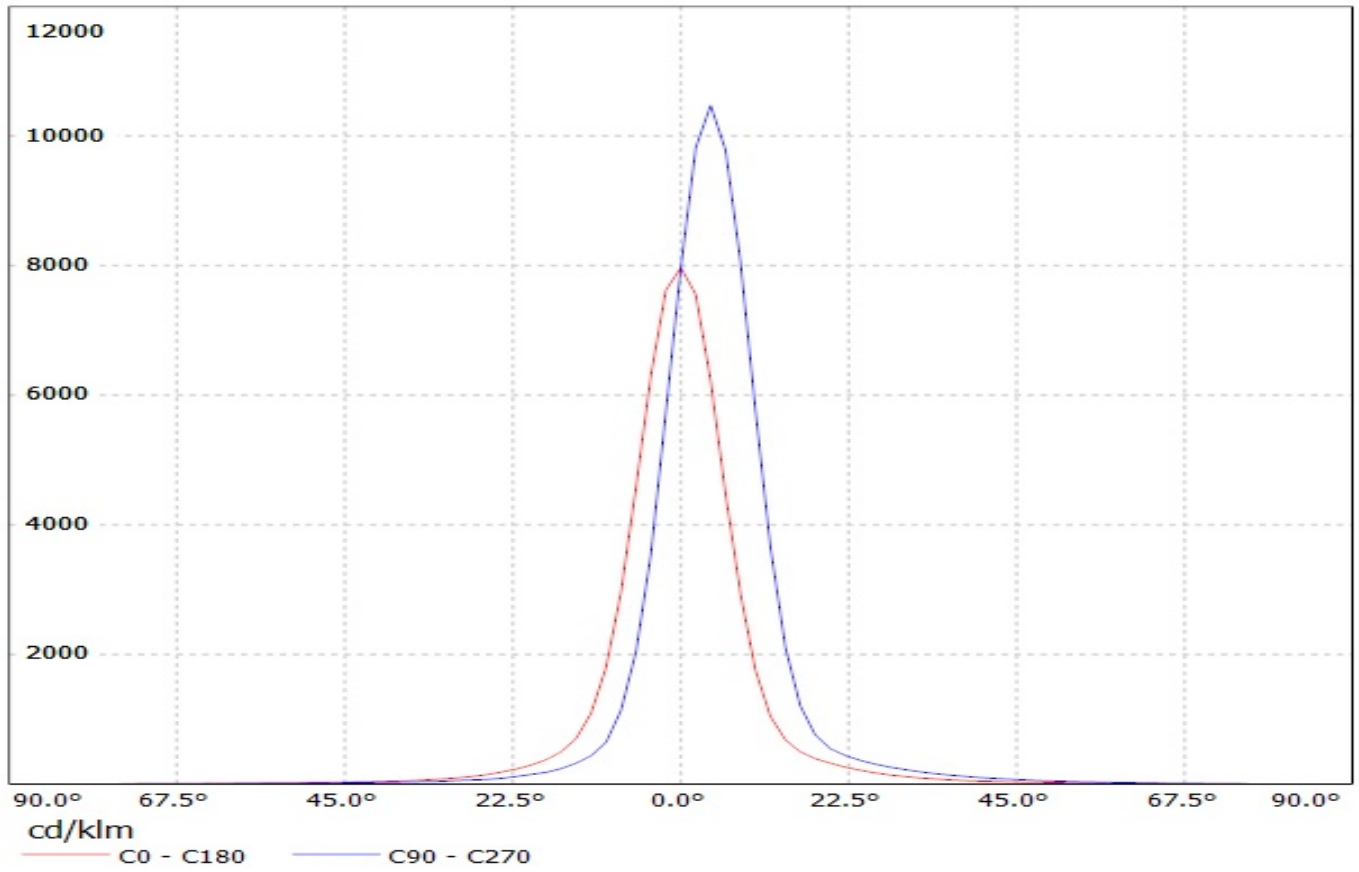

Luminaire: LEDiL Oy CA11998_EMILY-SS-WAS_(XP-L_HI)
Lamps: 1 x Cree_XP-L_HI_114.406lm@250mA_P=0.745352W_I=0.2499A

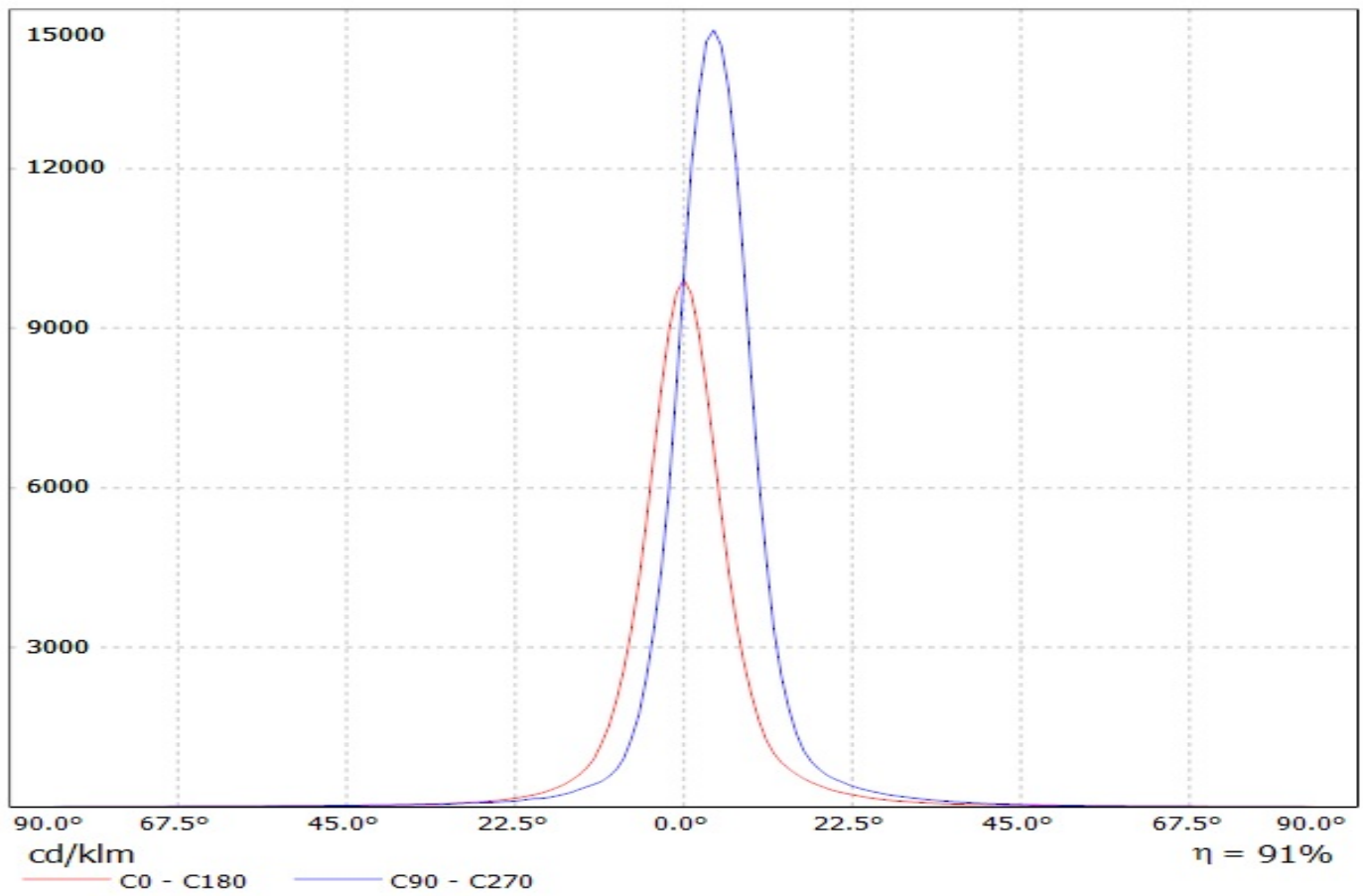

LEDiL Oy CA11998_EMILY-SS-WAS_(LUXEON_T)_2 Eff.88.8% / LDC (Linear)

Luminaire: LEDiL Oy CA11998_EMILY-SS-WAS_(LUXEON_T)_2 Eff.88.8%
Lamps: 1 x LUXEON T (74lm@250mA)

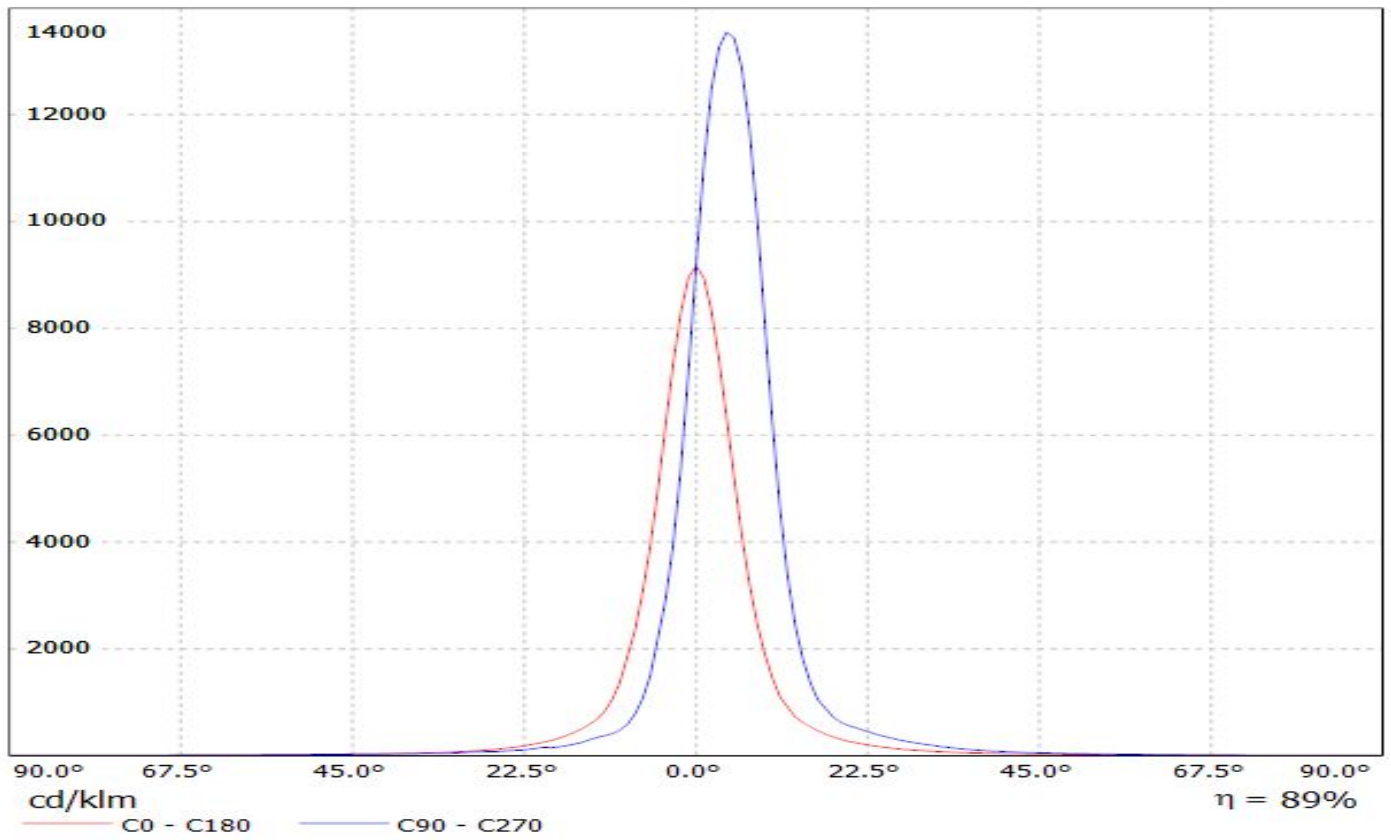

Luminaire: LEDil Oy CA11998_EMILY-SS-WAS_(Luxeon_TX)

Lamps: 1 x Philips Lumileds Luxeon TX (L1T2-3585) 80.38lm @ 250mA CCT=3554K P=0.7W I=250mA

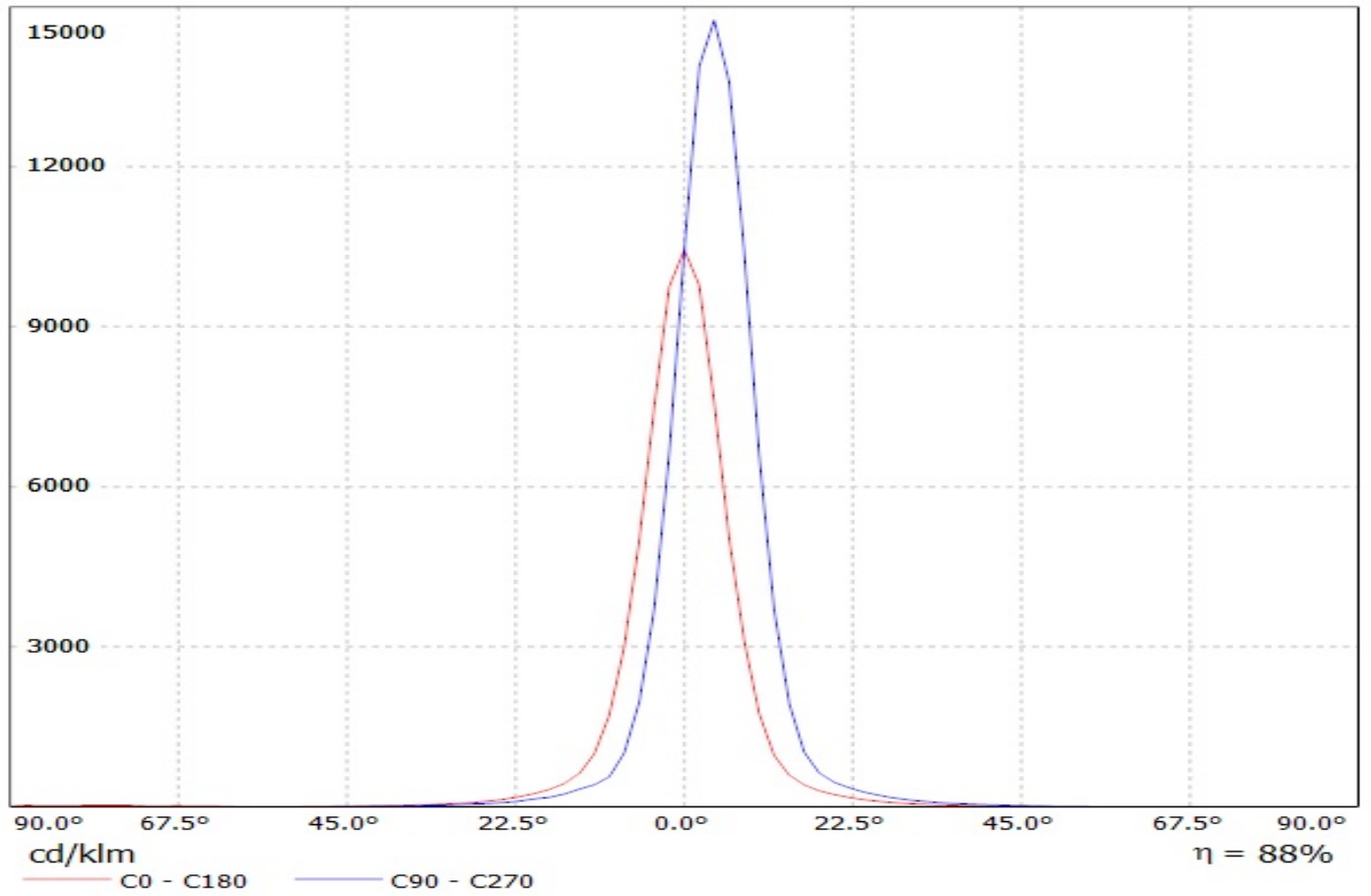

Luminaire: LEDiL Oy CA11998_EMILY-SS-WAS_(NCSxx19B) Eff. 89%
Lamps: 1 x Nichia NCSxx19B (NCSL119BE) 88lm @ 250mA CCT=3000K P=0.8W I=250mA

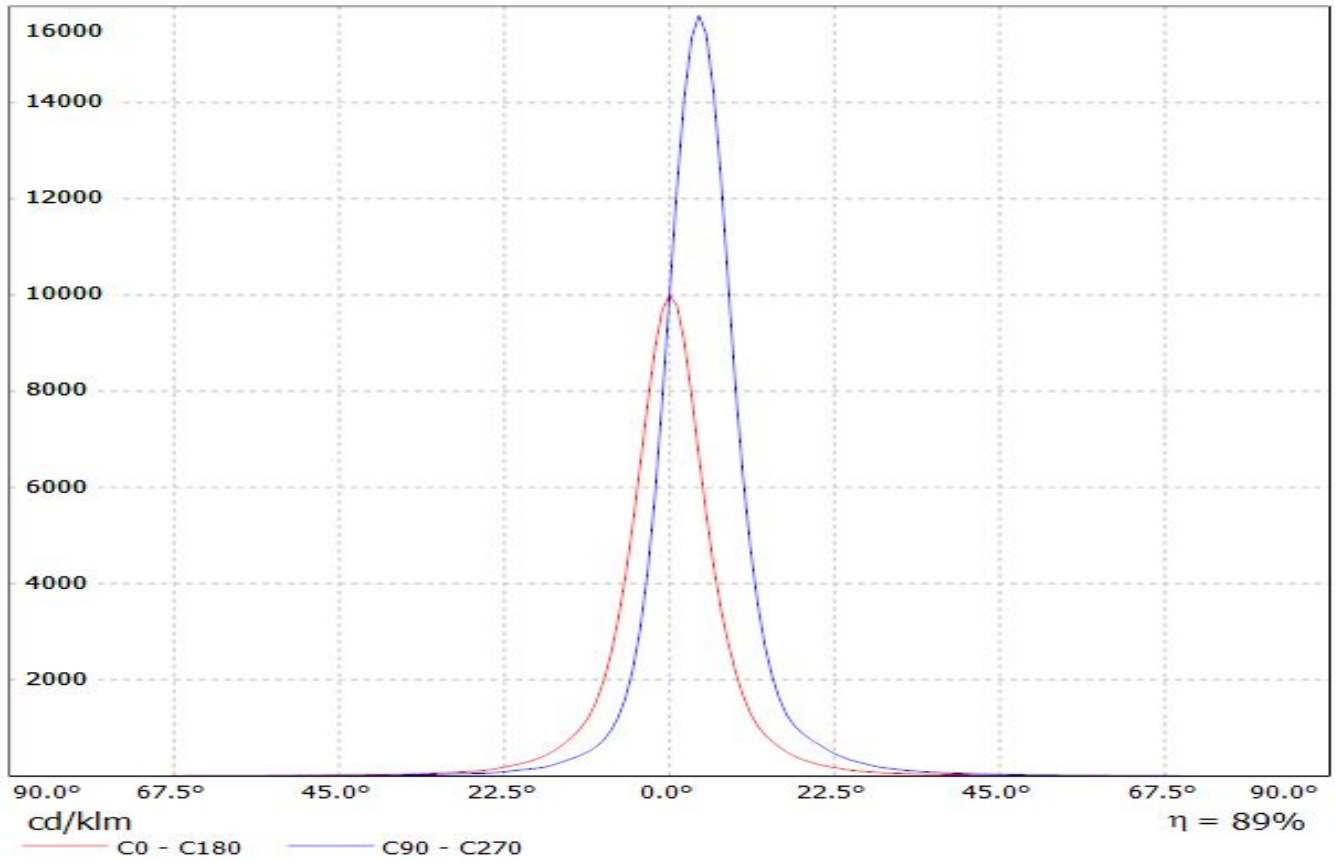

Luminaire: LEDiL Oy CA11998_EMILY-SS-WAS_(NVSL219CE)
Lamps: 1 x Nichia_NVSL219CE_101.227lm@250mA_P=0.713404W_I=0.25A

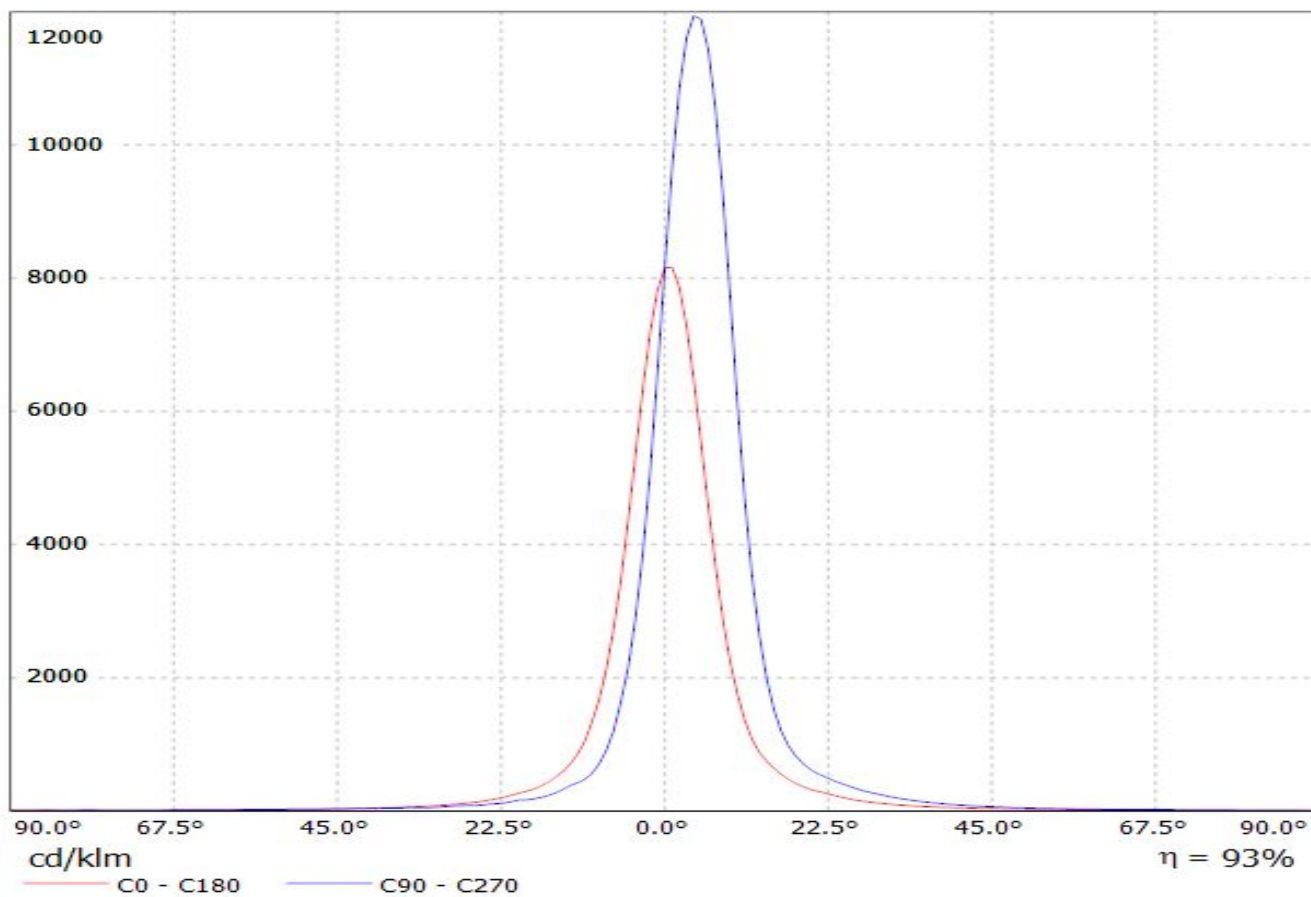

Luminaire: LEDil Oy CA11998_EMILY-SS-WAS_(Z5M1) Efficiency=88%
Lamps: 1 x Seoul Z5M1 (SZ5M1-W0-C8/W1-A5-G) 108lm @ 250mA CCT=9100K P=0.8W I=250mA

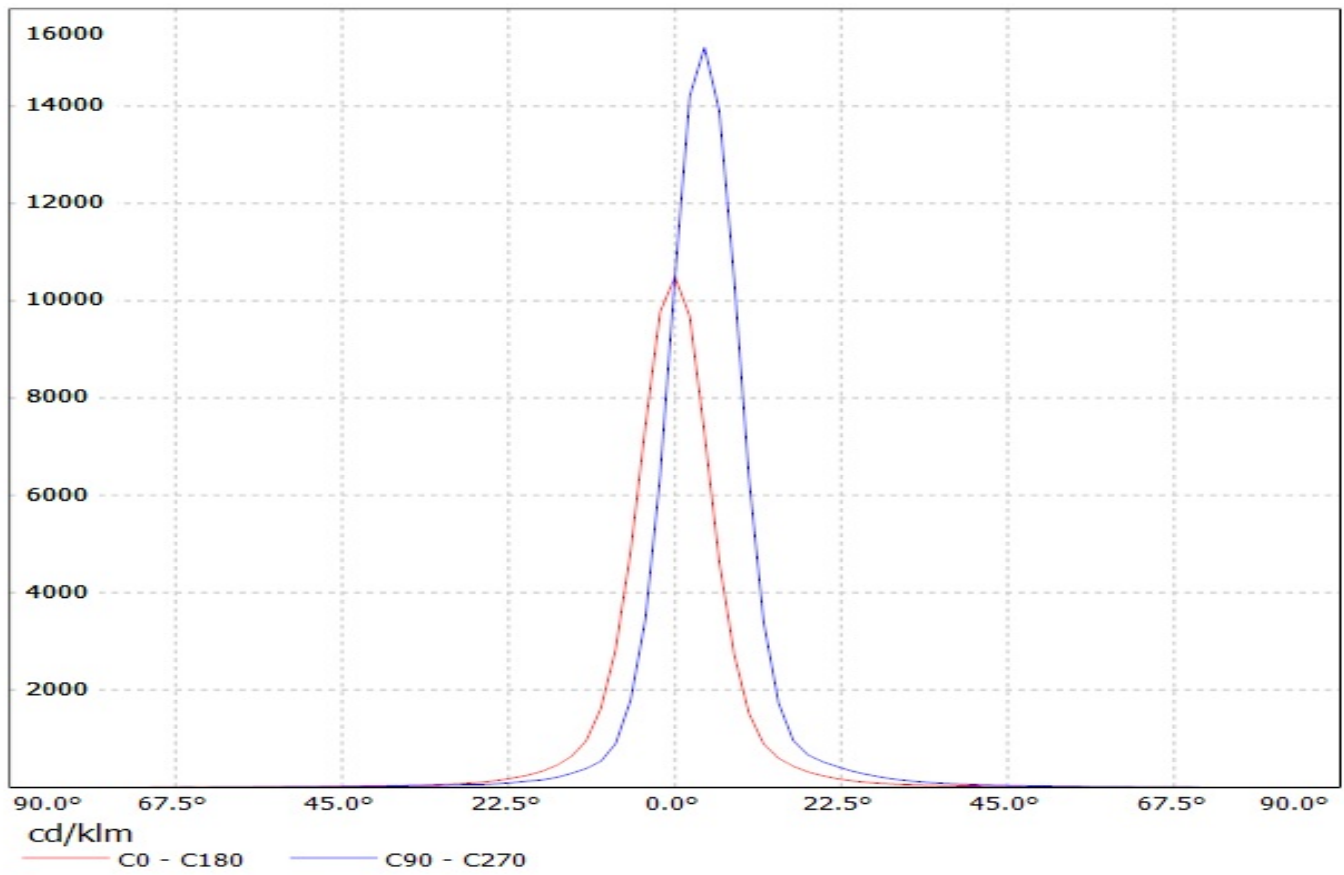

Luminaire: Ledil Oy CA11998_Emily-SS-was-Tape-RE LOR=92%

Lamps: 1 x Luxeon Rebel 72lm 250mA

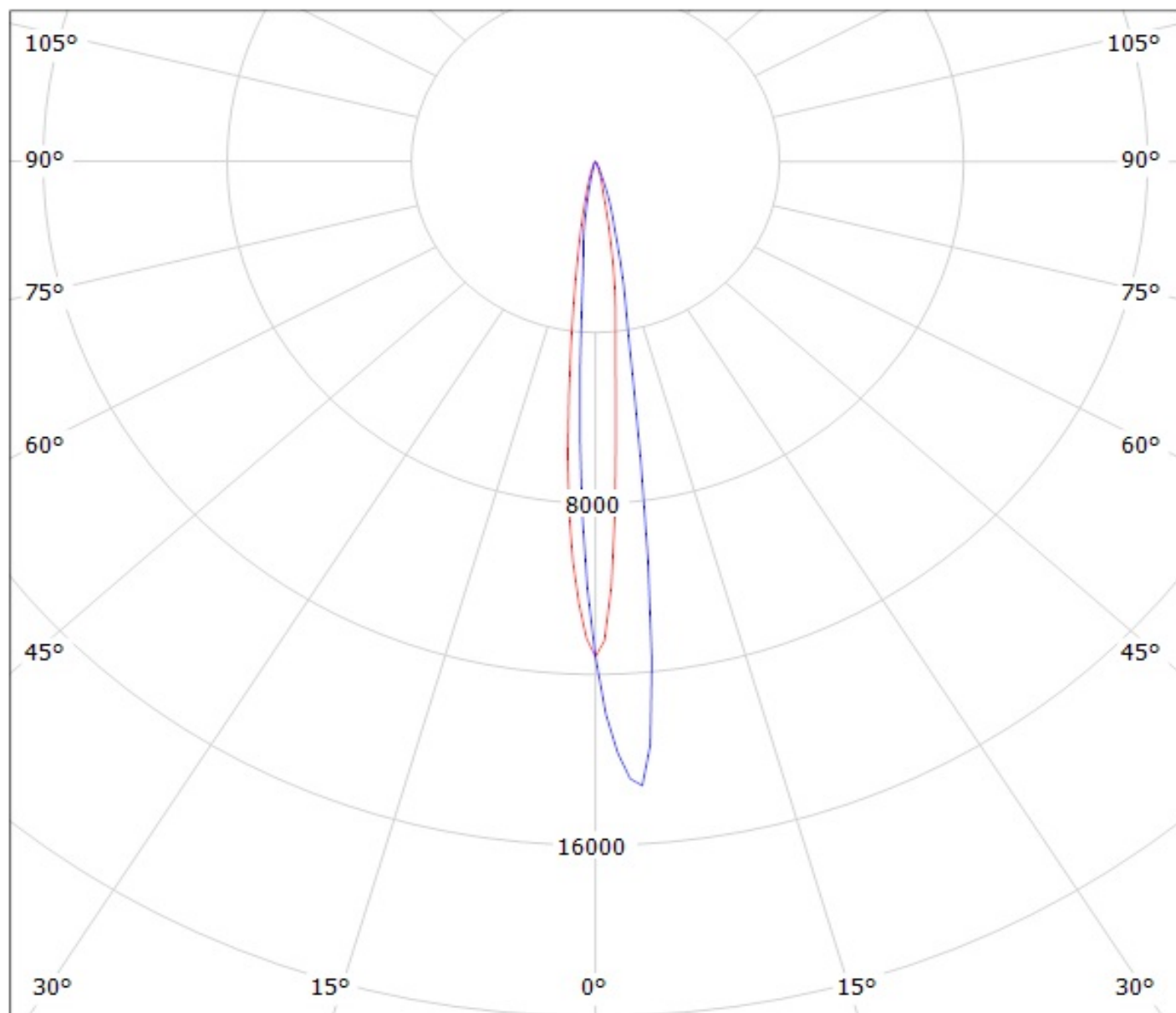

cd/klm

— C0 - C180

— C90 - C270

Luminaire: LEDil Oy CA11998_EMILY-SS-WAS_(XM-L2) Efficiency=88%
Lamps: 1 x Cree XM-L2 (XMLBWT-0-7B4-T30-0L-0001) 91lm @ 250mA CCT=3200K P=0.7W I=250mA

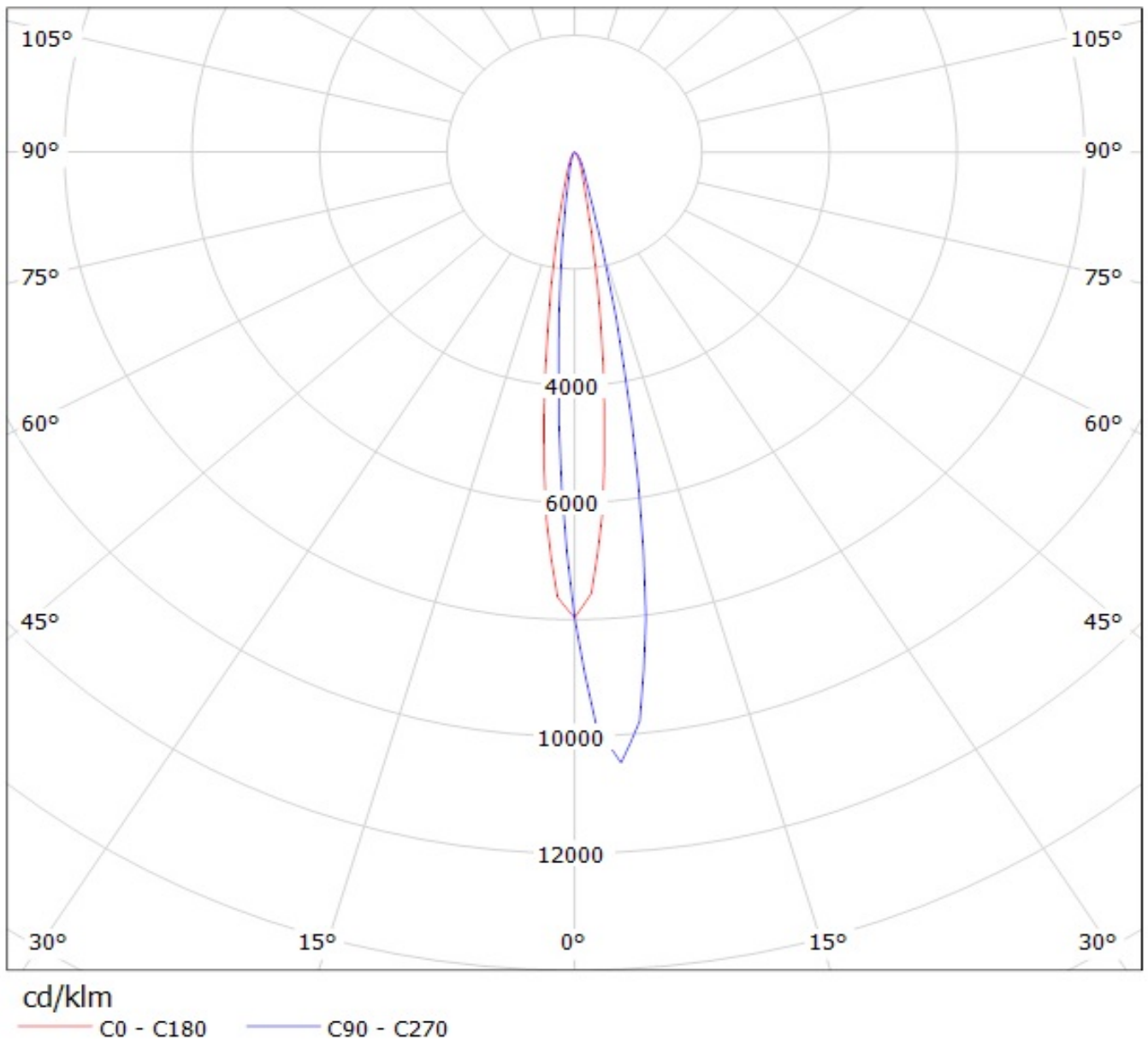

Luminaire: LEDiL Oy CA11998_EMILY-SS-WAS_(XP-L_HI)

Lamps: 1 x Cree_XP-L_HI_114.406lm@250mA_P=0.745352W_I=0.2499A

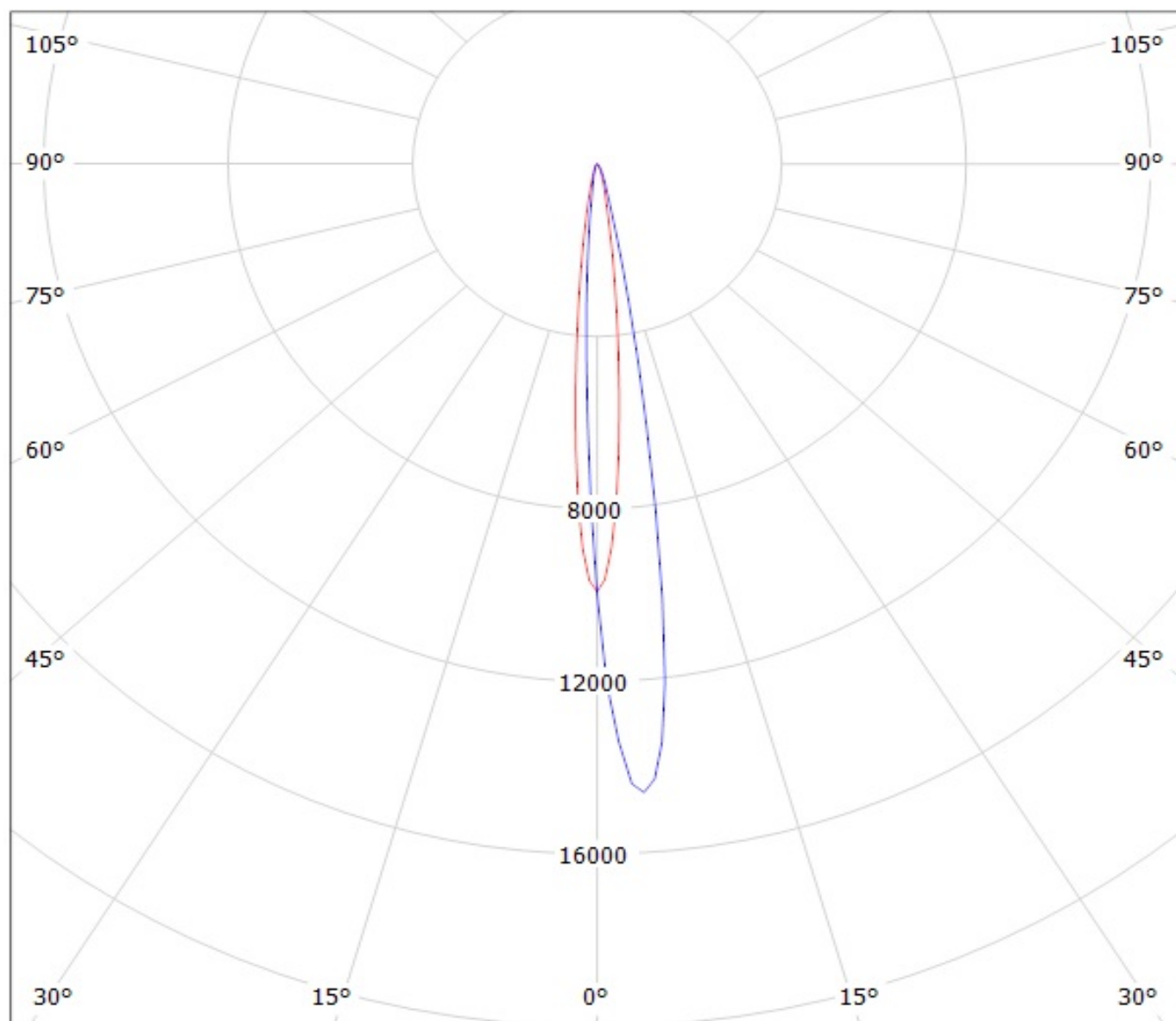

cd/klm

— C0 - C180

— C90 - C270

$\eta = 91\%$

LEDiL Oy CA11998_EMILY-SS-WAS_(LUXEON_T)_2 Eff.88.8% / LDC (Polar)

Luminaire: LEDiL Oy CA11998_EMILY-SS-WAS_(LUXEON_T)_2 Eff.88.8%

Lamps: 1 x LUXEON T (74lm@250mA)

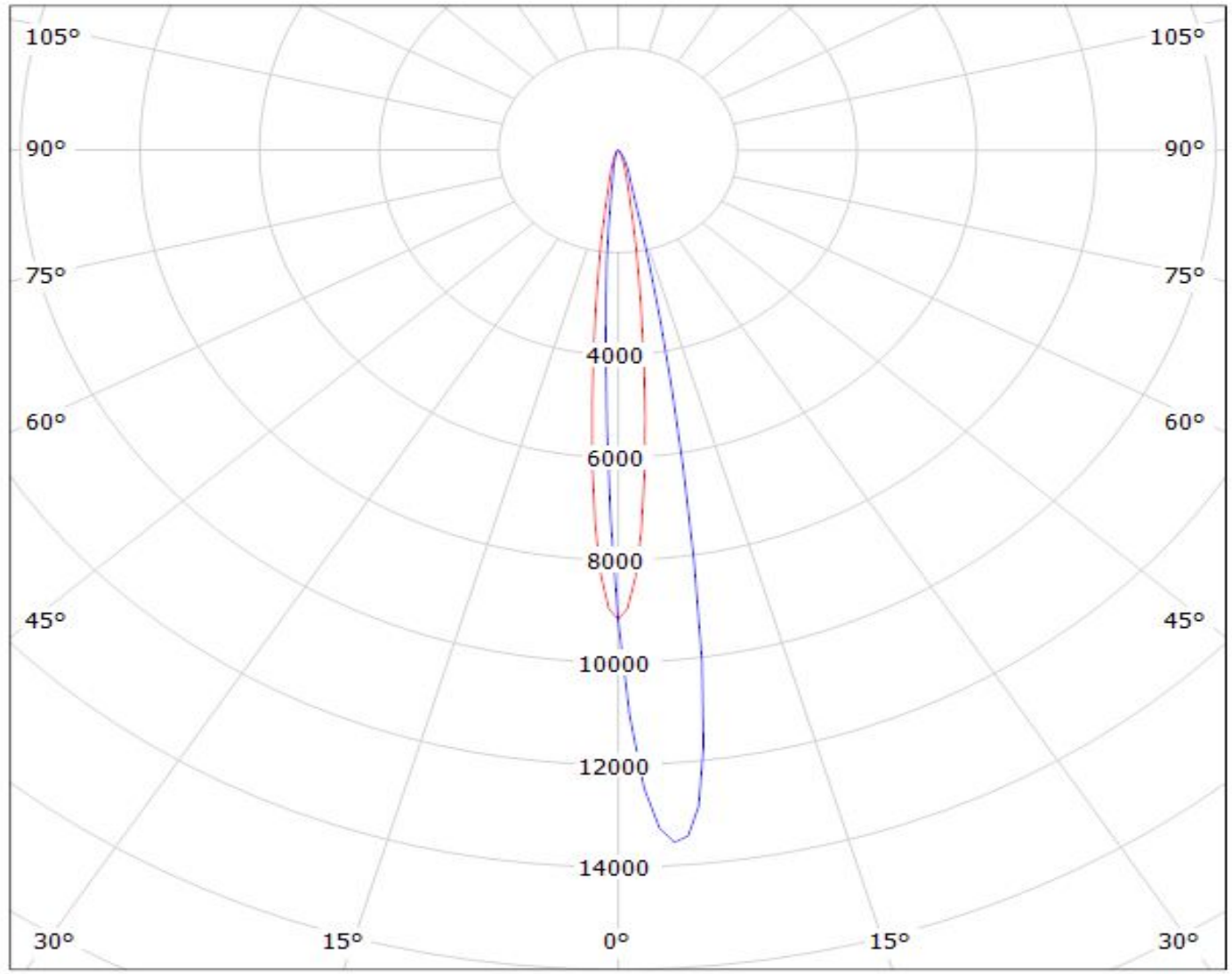

cd/klm

— C0 - C180

— C90 - C270

$\eta = 89\%$

Luminaire: LEDil Oy CA11998_EMILY-SS-WAS_(Luxeon_TX)

Lamps: 1 x Philips Lumileds Luxeon TX (L1T2-3585) 80.38lm @ 250mA CCT=3554K P=0.7W I=250mA

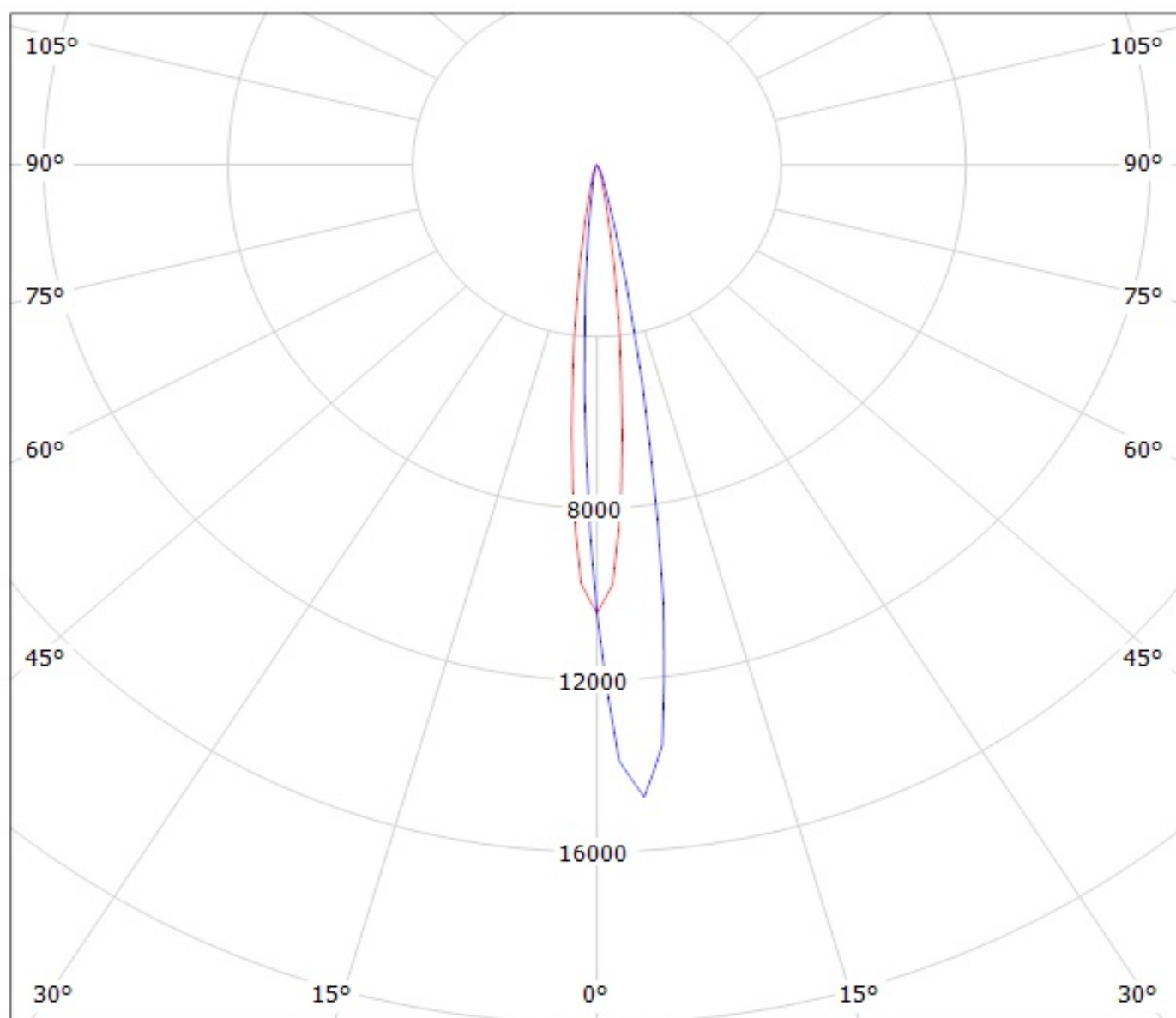

cd/klm

— C0 - C180

— C90 - C270

$\eta = 88\%$

Luminaire: LEDiL Oy CA11998_EMILY-SS-WAS_(NCSxx19B) Eff. 89%

Lamps: 1 x Nichia NCSxx19B (NCSL119BE) 88lm @ 250mA CCT=3000K P=0.8W I=250mA

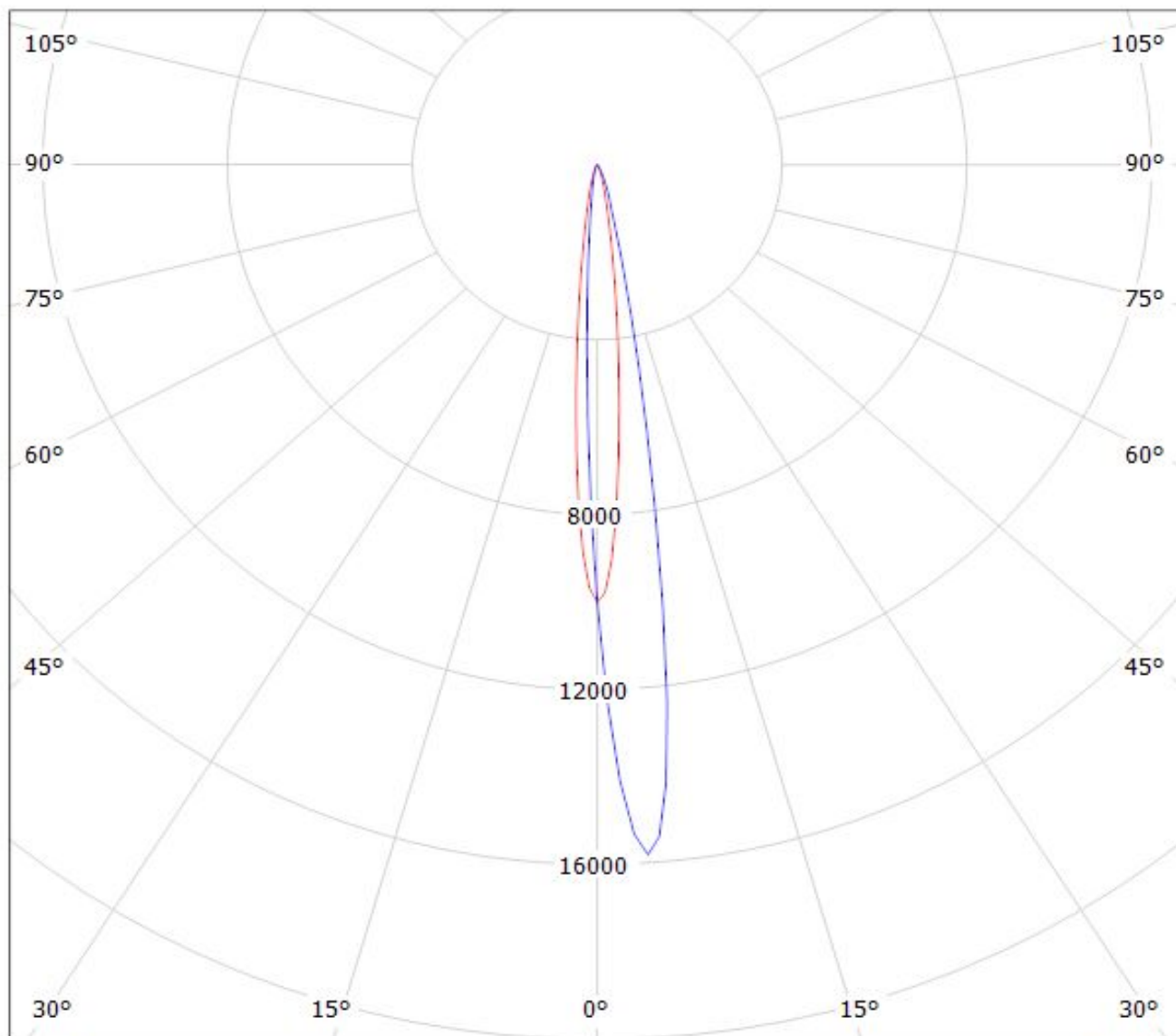

cd/klm

— C0 - C180 — C90 - C270

$\eta = 89\%$

Luminaire: LEDiL Oy CA11998_EMILY-SS-WAS_(NVSL219CE)
Lamps: 1 x Nichia_NVSL219CE_101.227lm@250mA_P=0.713404W_I=0.25A

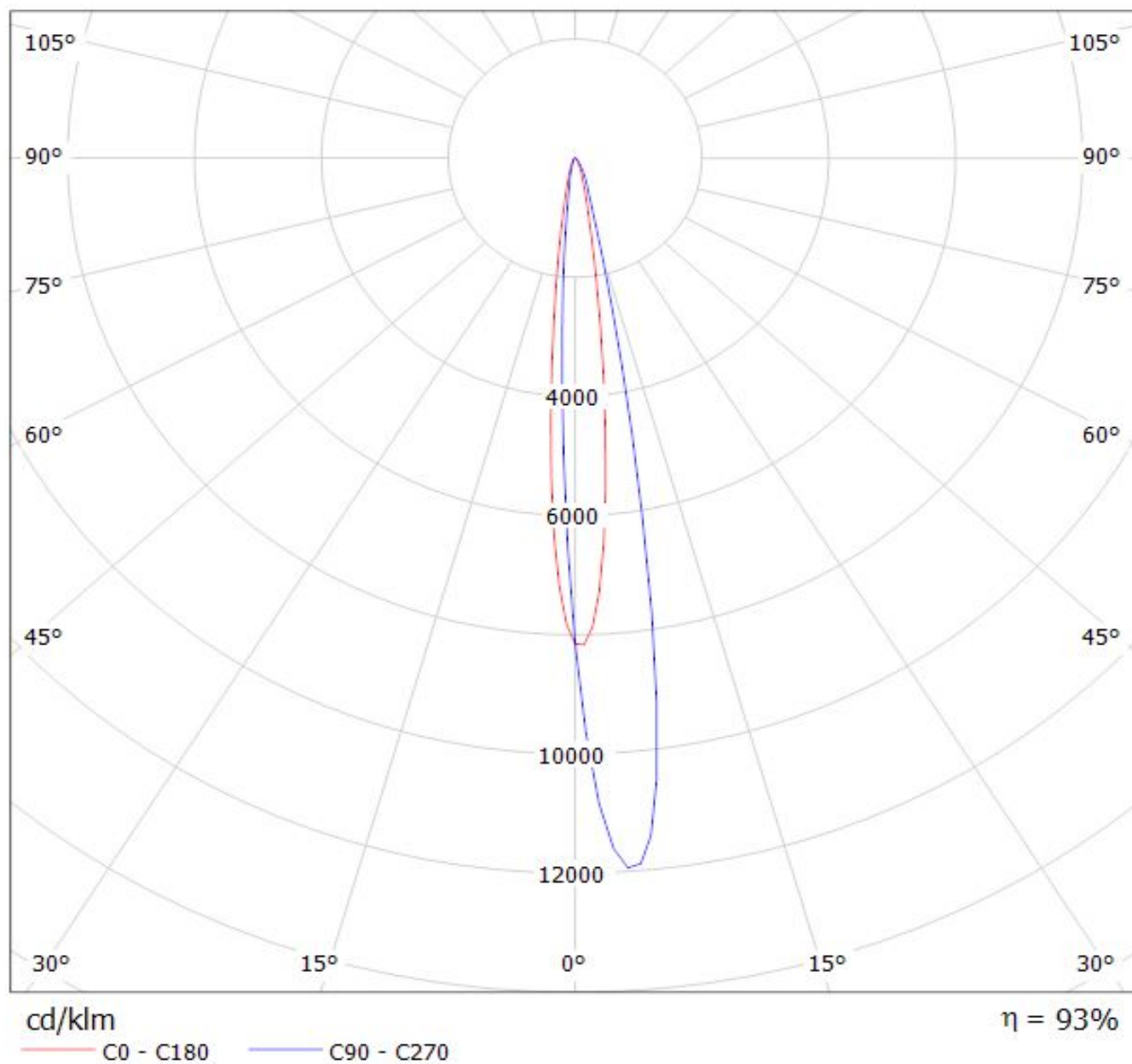

Luminaire: Ledil Oy CA11998_EMILY-SS-WAS (Oslon 150) Efficiency=88%
Lamps: 1 x Osram Oslon 150 deg white (95lm @ 250mA)

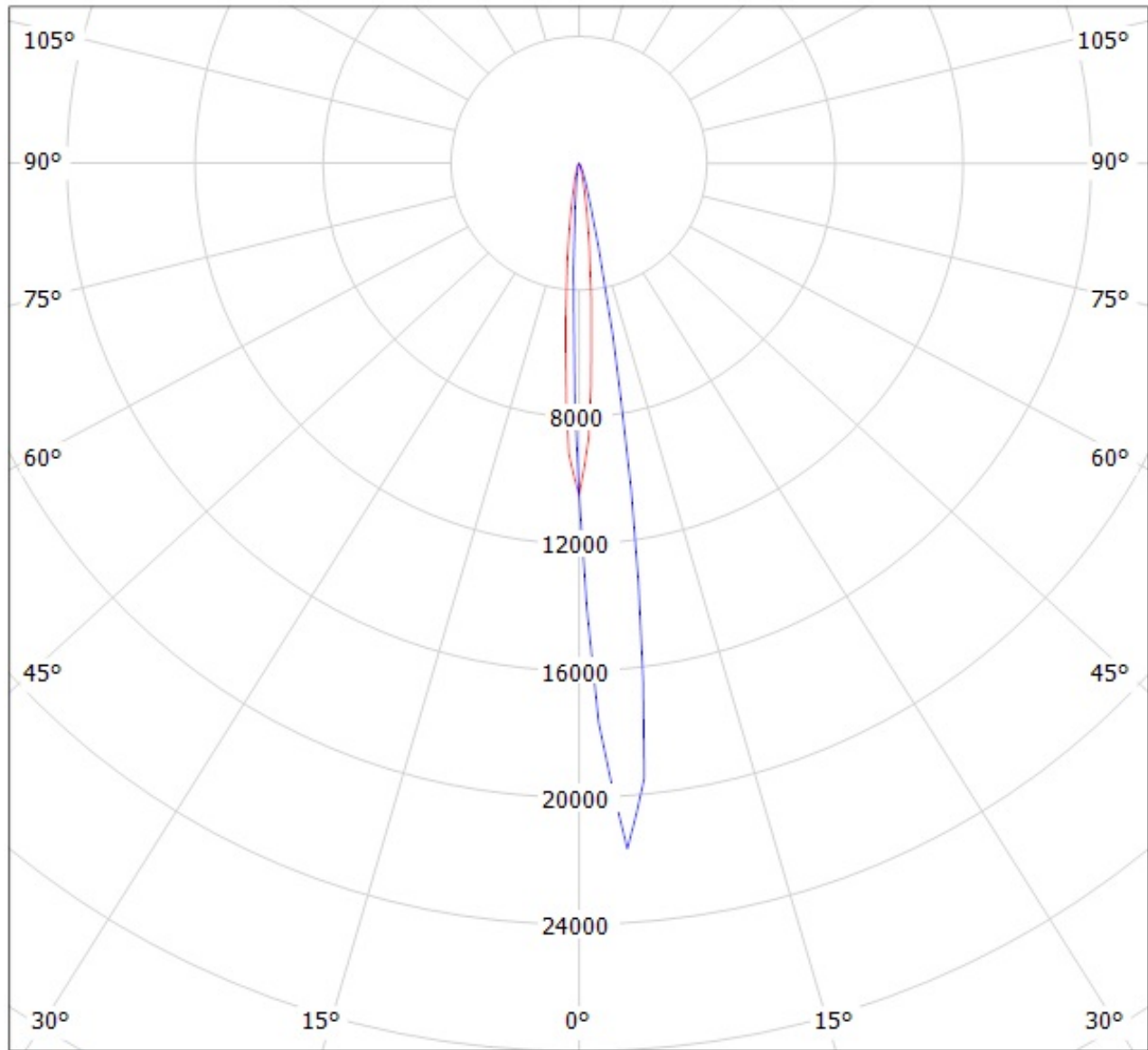

cd/klm

— C0 - C180

— C90 - C270

Luminaire: LEDil Oy CA11998_EMILY-SS-WAS_(Z5M1) Efficiency=88%

Lamps: 1 x Seoul Z5M1 (SZ5M1-W0-C8/W1-A5-G) 108lm @ 250mA CCT=9100K P=0.8W I=250mA

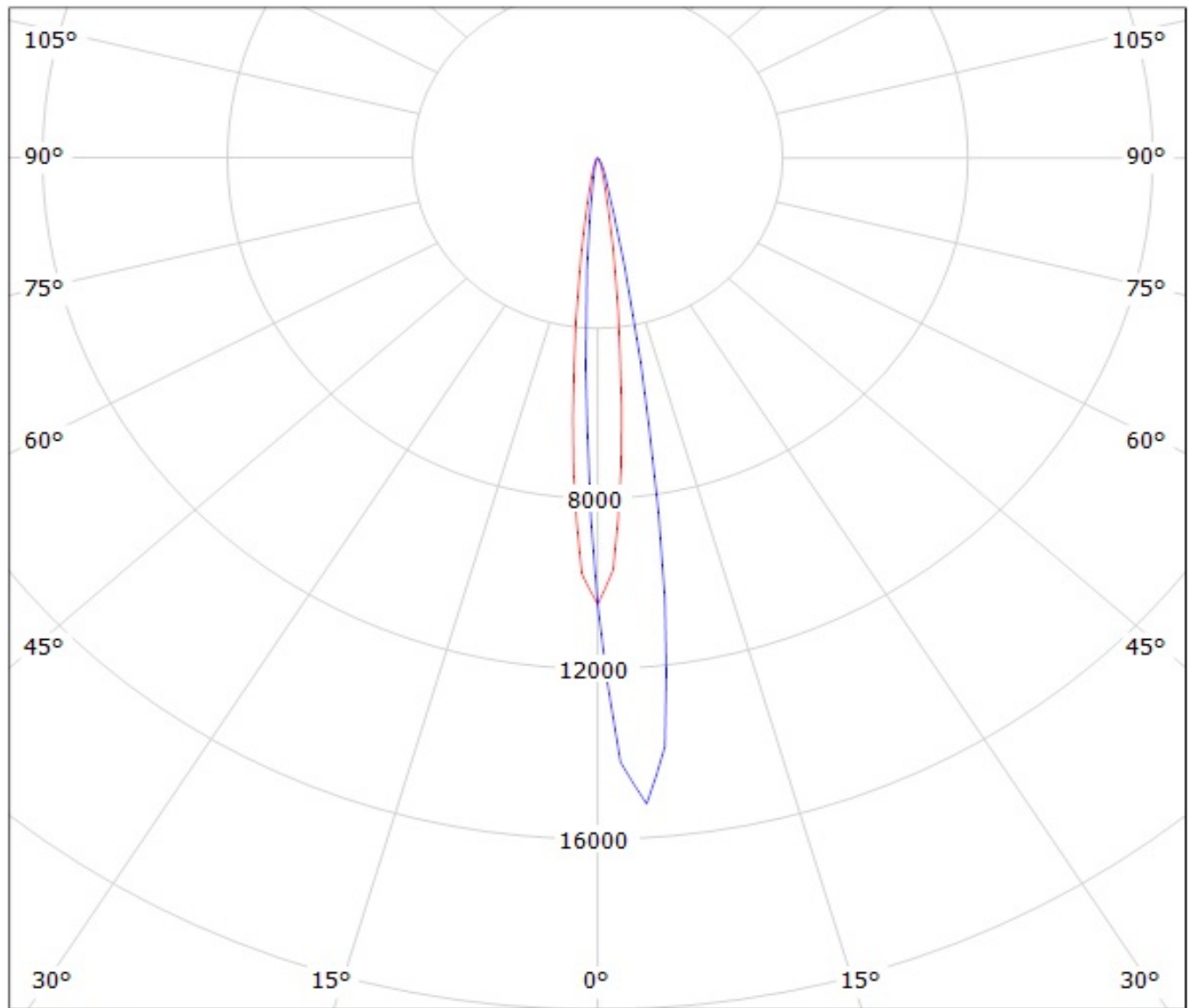

cd/klm

— C0 - C180

— C90 - C270

NOTE: The typical divergence will be changed by different color, chip size and chip position tolerance. The typical total divergence is the full angle measured where the luminous intensity is half of the peak value.