

Electronic Timing Relays

Type JCK Class 9050

Catalog
2013



- Application, General Information. 4
- Selection 6
- Specifications 8
- Dimensions, Wiring Diagrams. 9
- Accessories 10

Timing Functions

Class 9050 Type		JCK1•/ JCK60	JCK2•	JCK3•	JCK4•	JCK5•	JCK70
Timing Functions	On Delay						
	Off Delay						
	Off Delay Power Trigger						
	Interval						
	One Shot						
	One Shot Power Trigger						
	Repeat Cycle–Off						
	Repeat Cycle–On						
	On/Off Delay						
	One Shot Falling Edge						
	Watchdog						
	Trigger On Delay						
Number of Pins		8	11	8	11	8	11

9050JCK Electronic Timing Functions





Function	Description	Timing Diagram
On Delay	When the input voltage is applied, the time delay begins. Relay contacts change state after time delay is complete. When the input voltage is removed, contacts return to their shelf state. The trigger switch is not used in this function.	
Interval	When the input voltage is applied, the relay contacts change state immediately and the timing cycle begins. When the time delay is complete, or when the input voltage is removed, contacts return to shelf state. The trigger switch is not used in this function.	
Off Delay Switch and Power Trigger	Input voltage must be applied continuously. When the trigger switch closes, the relay contacts change state. When the trigger switch opens, the time delay begins. When the delay is complete, the contacts return to their shelf state. If the trigger switch closes before the time delay is complete, then timing is reset. When the trigger switch opens, the delay begins again, and the relay contacts remain in their energized state. If the input voltage is removed, the relay contacts return to their shelf state.	
One Shot Switch and Power Trigger	Input voltage must be applied continuously. When the trigger switch closes, the relay contacts change state and the pre-set delay begins. During time-out, the trigger signal is ignored. If the input voltage is removed, the relay contacts return to their shelf state.	

9050JCK Electronic Timing Functions

Function	Description	Timing Diagram
Repeat Cycle-Off	When input voltage is applied, the time delay T1 begins. When time delay T1 is complete, the relay contacts change state for time delay T2. This cycle repeats until the input voltage is removed. The trigger switch is not used in this function. Two dials are provided for independently adjustable repeat cycle timing ranges. For JCK70 timing relay, T1 equals T2.	
Repeat Cycle-On	When input voltage is applied, the relay contacts change state immediately and time delay T1 begins. When time delay T1 is complete, the contacts return to their shelf state for time delay T1. This cycle repeats until the input voltage is removed. The trigger switch is not used in this function.	
On/Off Delay	Upon application of input voltage, the time delay relay is ready to accept trigger signals. When the trigger switch closes, a pre-set On delay begins. At the end of the On delay, the relay contacts change state. When the trigger switch opens, the relay contacts remain in the current state until the pre-set Off delay elapses. At the end of the Off delay, the relay contacts return to their shelf state. The cycle can be repeated by re-closing the trigger switch after the timing cycle ends. If the trigger switch opens before the On delay elapses, the relay remains in its shelf state, and the delay timer resets. If the trigger switch re-closes before the Off delay elapses, the relay remains in its changed state, and the delay timer resets.	
One Shot Falling Edge	Upon application of input voltage, the time delay relay is ready to accept trigger signals. When the trigger switch opens, the relay contacts change state and a pre-set time delay begins. At the end of the time delay, the relay contacts return to their shelf state unless the trigger switch closes and opens before the time delay elapses. Continuous cycling of the trigger signal at a rate faster than the time delay causes the relay to remain in its changed state.	
Watchdog	Upon application of input voltage, the time delay relay is ready to accept trigger signals. When the trigger switch closes, the relay contacts change state and the pre-set time delay begins. At the end of the time delay, the relay contacts return to their shelf state unless the trigger switch closes and opens before the time delay elapses. Continuous cycling of the trigger signal at a rate faster than the delay time causes the relay to remain in its changed state.	
Trigger On Delay	Upon application of input voltage, the time delay relay is ready to accept trigger signals. When the trigger switch closes, a pre-set time delay begins. At the end of the pre-set time delay, the relay contacts change state and remain in that position as long as either the trigger signal is maintained or the input voltage remains. If the trigger switch opens during the time delay, the relay contacts remain.	

Type JCK Electronic Timing Relays

Type JCK11 – JCK59

				
File E78351 CCN NLDX2 (without socket)	File 78351 CCN NLDX (with the proper socket from page 10)	File 214768 Class 3211 07		

Features:

- Up to ±0.1% repeat accuracy
- Timing from 0.1 seconds to 120 minutes
- Available in 7 different timing functions
- DPDT contacts (2 N.O. & 2 N.C.)
- 10 A contact rating
- Transient protected
- Hold-down spring available
- Variable or fixed time delay
- Horsepower rated



9050JCK11V20



9050JCK1F15V14



9050JCK11V14

Variable Time Delay

Specify the voltage code when ordering this product. Refer to the standard voltage codes listed below and insert the code as shown in “How To Order” below.

Knob Adjustable Timing Range	Functions						
	On Delay	Off Delay	Off Delay Power Trigger	Interval	One Shot	One Shot Power Trigger	Repeat Cycle
0.1–10 seconds	JCK11	JCK21	JCK21PT	JCK31	JCK41	JCK41PT	JCK51
0.3–30 seconds	JCK12	JCK22	JCK22PT	JCK32	JCK42	JCK42PT	JCK52
0.6–60 seconds	JCK13	JCK23	JCK23PT	JCK33	JCK43	JCK43PT	JCK53
1.2–120 seconds	JCK14	JCK24	JCK24PT	JCK34	JCK44	JCK44PT	JCK54
1.8–180 seconds	JCK15	JCK25	JCK25PT	JCK35	JCK45	JCK45PT	JCK55
0.1–10 minutes	JCK16	JCK26	JCK26PT	JCK36	JCK46	JCK46PT	JCK56
0.3–30 minutes	JCK17	JCK27	JCK27PT	JCK37	JCK47	JCK47PT	JCK57
0.6–60 minutes	JCK18	JCK28	JCK28PT	JCK38	JCK48	JCK48PT	JCK58
1.2–120 minutes	JCK19	JCK29	JCK29PT	JCK39	JCK49	JCK49PT	JCK59

Fixed Time Delay

Specify the voltage code when ordering this product. Refer to the standard voltage codes listed below and insert the code as shown in “How To Order” below.

Timing Function	Type (1)	Timing Range (seconds)
On Delay	JCK1F(XXXX)	0.1 to 7200
Off Delay	JCK2F(XXXX)	0.1 to 7200
On/Off Delay with Power Trigger	JCK2F(XXXX)PT	0.1 to 7200
Interval	JCK3F(XXXX)	0.1 to 7200
One Shot	JCK4F(XXXX)	0.1 to 7200
One Shot with Power Trigger (Falling Edge)	JCK4F(XXXX)PT	0.1 to 7200
Repeat Cycle	JCK5F(XXXX) JCK5F(XXXX)F(XXXX) (2)	0.1 to 7200

(1) (XXXX) denotes desired timing period in seconds. Example: Class 9050 Type JCK1F60 is an On Delay timer fixed at 60 seconds.





(2) Fixed repeat cycle timers are available with the same On and Off Times (for example., 9050JCK5F130V20) or different On and Off Times (for example, 9050JCK5F130F35V20). Specify the suffix for the Off Time (F130), then the suffix for the On Time (F35).

Voltage Codes

Voltage	Code
12 Vdc	V36
24 Vac / Vdc	V14
48 Vac / Vdc	V17
120 Vac / 110 Vdc	V20
240 Vac, 50 / 60 Hz	V24

How to Order Type JCK Timers

To Order, Specify:	Catalog Number Example		
	Class	Type	Voltage Code
Class Number Type Number Voltage Code	9050	JCK11	V20

				
File E78351 CCN NLDX2 (without socket)	File 78351 CCN NLDX (with the proper socket from page 10)	File 214768 Class 3211 07		

Features:

- Up to ±0.1% repeat accuracy
- Timing from 0.05 seconds to 999 hours
- Available in up to 10 timing functions
- DPDT contacts (2 N.O. & 2 N.C.)
- 10 A contact rating
- Transient protected
- Hold-down spring available
- Wide timing range
- Horsepower rated

Programmable Timers

Class 9050 Type JCK programmable timers are microprocessor controlled to provide flexibility with accurate timing. The Type JCK60 On Delay timer has seven programmable timing ranges. The Type JCK70 multifunction timer has 10 timing functions and seven programmable timing ranges. To program the timers, remove power and select the timing range and timing functions. Settings of less than 0.05 seconds are not recommended due to the response time of the electromechanical outputs.

Type JCK60 (On Delay)

This On Delay timer uses a push-button thumbwheel to select the timing range, and uses three push-button thumbwheels to select the time value.

	Timing Function	Timing Ranges	Type
	On Delay	0.01 s 0.05–9.99 seconds 0.1 s 0.1–99.9 seconds S 1–999 seconds 0.1 m 0.1–99.9 minutes M 1–999 minutes 0.1 h 0.1–99.9 hours H 1–999 hours	JCK60 (1)

(1) The voltage code must be specified to order this product. Refer to standard voltage codes listed below and insert the code as shown in “How To Order” below.

Type JCK70 (Multifunction)

One 10-position push button thumbwheel is used to select the function. Three 10-position push button thumbwheels are used to select the time value. One 7-position push button thumbwheel is used to select the timing range.

	Timing Functions	Timing Ranges	Type
	On Delay Interval Off Delay One Shot Repeat Cycle–Off (1) Repeat Cycle–On (1) On/Off Delay 1 Shot Falling Edge Watchdog Trig. On Delay	0.01 s 0.05–9.99 seconds 0.1 s 0.1–99.9 seconds S 1–999 seconds 0.1 m 0.1–99.9 minutes M 1–999 minutes 0.1 h 0.1–99.9 hours H 1–999 hours	JCK70 (2)

(1) The Repeat Cycle function uses the same On and Off times.

(2) Specify the voltage code when ordering this product. Refer to the standard voltage codes listed below and insert as shown in How To Order.

Note: Turn off power to the 9050JCK70 before changing the timing function.

Voltage Codes

Voltage	Code
12 Vdc	V36
24 Vac / Vdc	V14
48 Vac / Vdc	V17
120 Vac / 110 Vdc	V20

How to Order Type JCK Timers

To Order, Specify:	Catalog Number Example		
	Class	Type	Voltage Code
Class Number Type Number Voltage Code	9050	JCK60	V24

Operating Specifications

Voltage range	AC operation		+10%, -15% of nominal @ 50/60 Hz
	DC operation		+10%, -15% of nominal
Repeat accuracy	For constant voltage and temperature	9050JCK11-59	±0.1%, ±0.04 s, whichever is greater
		9050JCK60-70	±0.1% of set time or ± 0.02 ms, whichever is greater
	For variable voltage and temperature, within specs	9050JCK11-59	±10%
		9050JCK60-70	±0.1% of set time or 0.02 s, whichever is greater
Reset time	All functions		100 ms
Temperature range	Operating (with the proper derating, see curve on page 9)	12-120 Vac/Vdc	-18 to +150 °F (-28 to +65 °C)
		240 Vac	-18 to +122 °F (-28 to +50 °C)
	Storage		-67 to +185 °F (-55 to +85 °C)
IEC 60664-1	Degree of pollution		2
	Overvoltage category		III
Contact material			Silver nickel
Mounting position			indifferent
Burden	9050JCK11-59, 1, 2-120 Vac/Vdc		2.0 VA
	9050JCK11-59, 240 Vac		3.0 VA
	9050JCK60-70, 12-120 Vac/Vdc		3.0 VA
	9050JCK60-70, 240 Vac		3.2 VA
Relative humidity			15% to 85%, per IEC 60068-2-3
Insulation test voltage	9050JCK11-59 9050JCK60-70		2,000 Vac
			1,500 Vac between coil and contacts
			1,000 Vac between open contacts
			1,500 Vac between contacts of different circuitry
Transient protection			13 J, 10x 1000 µs
Vibration			10-55 Hz, 3 g max., 0.5 mm total displacement (+0.25 mm)
Shock			30 g, 11 ms duration, half sine wave
Endurance (1)	Mechanical (no load, 18,000 operations/hr max.)		10 million operations
	Electrical (full rated load, 1,800 operations/hr max., operating temperature -18 to 104 °F [-28 to 40 °C]).		100,000 operations
Degree of protection (IEC 60529)			IP20
Max. switching frequency			1800 cycles per hour
Compliance	UL Component Recognized File		E78351 CCN NLDX2 (without socket)
	UL Listed File		E78351 CCN NLDX (with the proper socket from page 10)
	CSA		File 214768 Class 3211 07
	CE		EN60947-4-1, EN60947-5-1, EN61812-1
	RoHS		As of Series E for JCK1-59 As of Series D for JCK60 and JCK70
Fuse			10 A, Class CC (e.g., Bussmann KTK-R 10)

(1) The product life expressed on this page is based on average and normal operating conditions. Actual life will vary with conditions. The above statements are not intended to, nor shall they, create any expressed or implied warranties as to product operation or life. For more information on the listed warranty offered on this product, refer to the Terms and Conditions of sale found in the Digest.

Electromagnetic Compatibility (EMC) Ratings

Test	IEC	Level
Electrostatic discharge	61000-4-2	3 (6 kV, 8 kV)
Radiated, radio-frequency, electromagnetic field	61000-4-3	3 (10 V/m)
Electrical fast transient/burst	61000-4-4	3 (2 kV, 1 kV) (1)
Surge	61000-4-5	3 (2 kV, 1 kV) (1)
Conducted disturbances, induced by radio-frequency fields	61000-4-6	3 (10 V/m)
Radiated emissions	CISPR 22	
Conducted emissions	CISPR 22	

(1) Supply port, output port, and control port

LED Indicators (1)

LED	State
Steady (On)	Power present
Flashing	Device is timing

(1) The LED is not an indicator of the output state of the timing relay.

Dimensions — inches mm

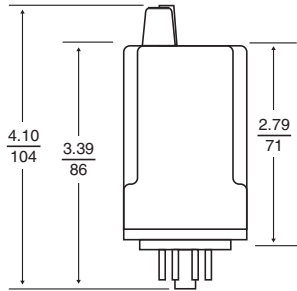

Dimensions of Type JCK11 – JCK59

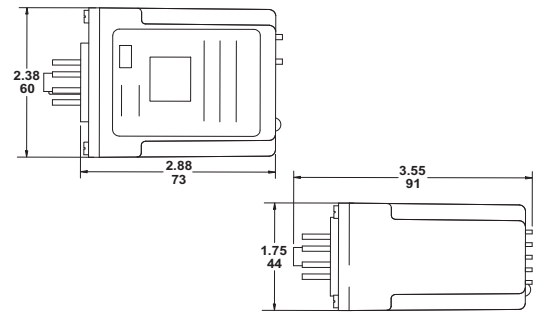
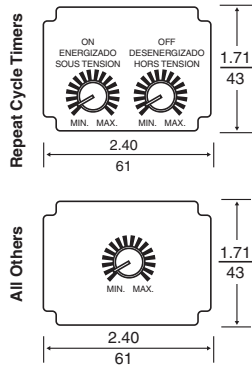

Dimensions of Type JCK60 and JCK70

AC Maximum Contact Ratings

AC Voltage		120 / 240 Vac (N.C.)	120 / 240 Vac (N.O.)	
Horsepower		1/3	1/2	
AC Amperes	Resistive 75% P.F. Make, Break, and Continuous	10	10	
	Inductive 35% P.F.	Continuous	10	
		Break	3	1.5
		Make	30	15

Contact Derating Curve

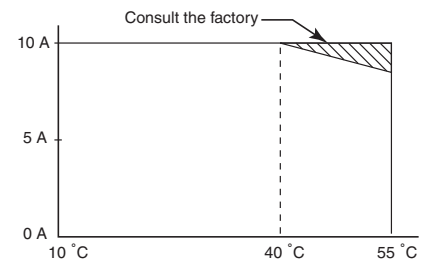

DC Maximum Contact Ratings

DC Volts		30	
DC Amperes	Resistive Make, Break, and Continuous	10	
	Inductive	Make	3
		Break	3

AC15/B300 (NO/NC), DC13/R300 (NO)
Recommended minimum load current is 100 mA @ 12 Vdc.

Wiring Diagrams

Type (1):
JCK11 – JCK19
JCK31 – JCK39
JCK51 – JCK59
JCK60

Type (1) (2):
JCK21 – JCK29
JCK41 – JCK49

Type (1):
JCK21PT – JCK29PT
JCK41PT – JCK49PT

Type (1):
JCK70

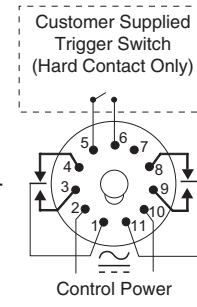
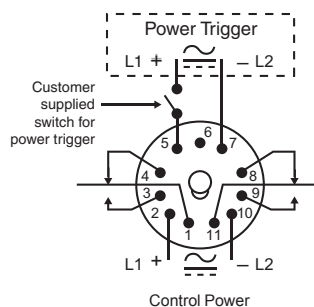
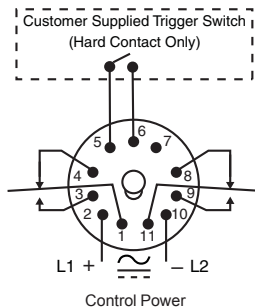
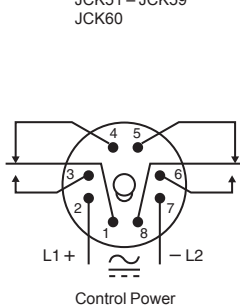

(1) Do not apply DC voltage to the 240 Vac timers (voltage code V24).
(2) There is no internal jumper between pins 6 and 7.

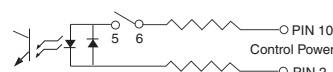

NOTES:

- Use the same voltage for the power trigger and control power. Do not use terminal 6 with power trigger devices.
- For timers that use trigger switches, the maximum distance for the trigger switch is 50 ft. from the timer.

Conformity to Standards (Sockets Only):



Input Compatibility

The Type JCK timer is not compatible with 2-wire AC input sensors. A hard contact relay (for instance, a general purpose relay) must be interposed. Class 8501 Type NR sockets are designed for use with plug-in Class 9050 Type JCK timers. All sockets have pressure clamps that accept one or two #12–22 AWG wires. The recommended tightening torque for all terminals is 7–8 lb-in.

- 35 mm DIN 3 track mounting or direct panel mounting
- Tubular sockets available in easy-to-wire single tier or space-saving multi-tier versions
- All sockets are stocked

Snapmount Sockets-Screw Terminal



8501NR51



8501NR52



8501NR61



8501NR62



8501NH7

For Use with Class 9050 Type	Description	Socket Rating		Type	Order Qty.
JCK11–19 JCK31–39 JCK51–59 JCK60 JCK1F JCK3F JCK5F	8–Pin Tubular Single Tier	UL	10 A @ 600 V, 15 A @ 300 V	8501NR51	1
		CSA	10 A @ 300 V	8501NR51B	10 (bulk package)
	8–Pin Tubular Double Tier	UL	5 A @ 600 V, 16 A @ 300 V	8501NR52	1
		CSA	10 A @ 300 V	8501NR52B	10 (bulk package)
JCK21–29 JCK41–49 JCK70 JCK2F JCK4F	11–Pin Tubular Single Tier	UL	5 A @ 600 V, 15 A @ 300 V	8501NR61	1
		CSA	10 A @ 300 V (20 A max. load)	8501NR61B	10 (bulk package)
	11–Pin Tubular Three Tier	UL	5 A @ 600 V, 16 A @ 300 V	8501NR62 (1)	1
		CSA	10 A @ 300 V (20 A max. load)	8501NR62B	10 (bulk package)

(1) The 8501NR62 socket is approximately the same width as the base of the JCK timer. Use the wider NR61 where space permits for ease of wiring.

Class 8501 Hold-Down Spring

For Use on Class 9050 Type JCK Timers	Class	Type
Hold-down spring to hold the timer in its socket during heavy vibration. (See the photo on page 6 of the 9050JCK timer with the 8501NH7 hold-down spring attached.)	8501	NH7

Note: For DIN3 mounting track and end clamps, refer to the IEC type terminal block section in Catalog 9080CT9901.

Socket Dimensions and Wiring Diagrams — inches
mm

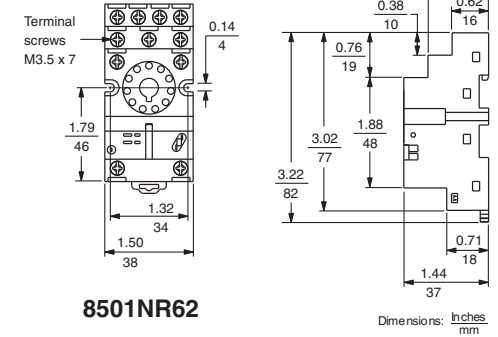
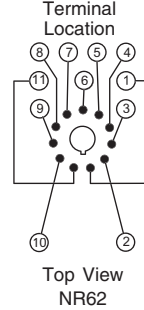
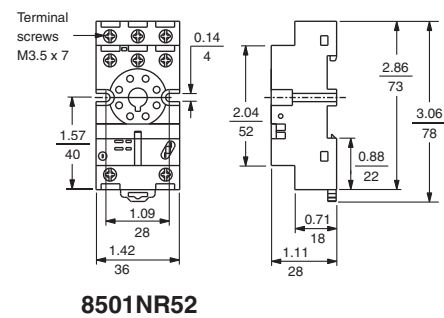
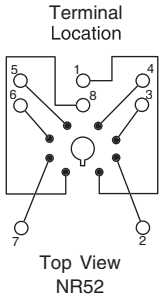
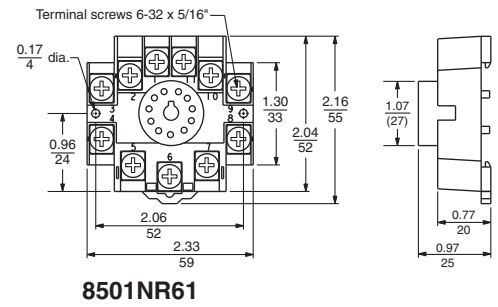
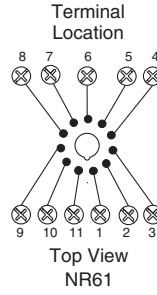
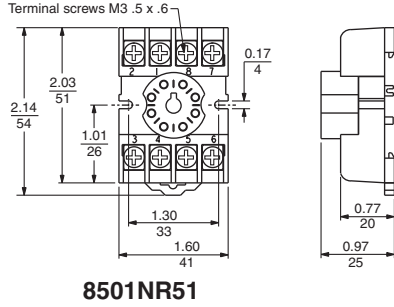
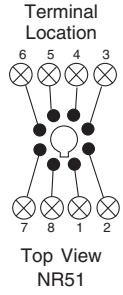

<http://www.schneider-electric.com/>

© 2013 Schneider Electric. All Rights Reserved

Schneider Electric and Square D are trademarks owned by Schneider Electric Industries SAS or its affiliated companies. All other trademarks are the property of their respective owners.

Schneider Electric USA, Inc.

1415 S. Roselle Road
Palatine, IL 60067 USA

Tel: 888-778-2733

www.schneider-electric.us

9050CT9601R06/13

Replaces 9050CT9601R03/09 dated 11/2011