

SMT Power Inductor

Round Wire Coils - PG0926NL series



- Inductance Range:** 0.46 μ H to 22.0 μ H
- Current Rating:** up to 50A_{pk}
- Footprint:** 13.4mm x 13.4mm Max
- Height:** 8.0mm Max
- No Thermal Aging**

Electrical Specifications @ 25°C - Operating Temperature -40°C to 130°C¹

Part Number	Inductance @ I _{rated} ² μ H TYPICAL	I _{rated} ³ (A)	CONTROLLED ELECTRICAL SPECS		SATURATION ⁵ CURRENT I _{sat} (A TYP)		HEATING ⁶ CURRENT I _{dc} (A TYP)	CORE LOSS ⁷ FACTOR (K2)
			DCR ⁴ (m Ω) \pm 12%	INDUCTANCE @0A _{dc} (μ \pm 20%)	25°C	100°C		
PG0926.461NL	0.42	44	0.55	0.46	50	40	44	32.9
PG0926.102NL	0.94	30	1.2	1.00	34	27	30	47.6
PG0926.182NL	1.7	22	2.2	1.80	25	21	22	64.3
PG0926.282NL	2.6	19	2.9	2.80	20	16	19	80.0
PG0926.562NL	5.0	14	4.1	5.60	14	11.5	14.5	114.3
PG0926.722NL	6.8	12	7.0	7.20	12.5	10	12	128.6
PG0926.872NL	8.4	11	8.0	8.70	11.5	9	11	138.1
PG0926.113NL	10.6	9.5	12.0	11.50	10.5	8	9.5	157.1
PG0926.153NL	13.5	8	12.5	15.00	9	7	8	194.8
PG0926.223NL	20	7	21.0	22.00	7.5	6	7	224.5

Notes:

- Actual temperature of the component during system operation (ambient plus temperature rise) must be within the standard operating range.
- Inductance at I_{rated} is a typical inductance value for the component taken at rated current.
- The rated current listed is either the saturation current (@ 25°C) or the heating current depending on which value is lower.
- The DCR of the part is measured at an ambient temperature of 20°C \pm 3°C from point a to b as shown below on the mechanical drawing.
- The saturation current, I_{sat}, is the current at which the component inductance drop by 20% (typical) at an ambient temperature. This current is determined by placing the component in the specified ambient environment and applying a short duration pulse current (to eliminate self-heating effect) to the component.
- The heating current, I_{dc}, is the DC current required to raise the component temperature by approximately 40°C. The heating current is determined by mounting the component on a typical PCB and applying current for 30 minutes. The temperature is measured by placing the thermocouple on top of the unit under test. Take note that the components' performance varies depending on the system condition. It is suggested that the component be tested at the system level, to verify the temperature rise of the component during system operation.
- Core loss approximation is based on published core data:
Core Loss = K1 * (f)^{1.72} * (K2 Δ I)^{2.41} in mW
K1 = 8.68E - 10
f = switching frequency in KHz
K1 & K2 = core loss factors
 Δ I = delta I across the component in Ampere
K2 Δ I = one half of the peak to peak flux density across the component in Gauss
- Unless otherwise specified, all testing is made at 100KHz, 0.1Vac
- Optional Tape and Reel packaging can be ordered by adding a "T" suffix to the part number (i.e. PG0926.223NL becomes PG0926.223NLT). Pulse complies with industry standard tape and reel specification EIA481. The tape and reel for this product has a width (W=32.0mm), pitch (Po=20.0mm) and depth (Ko=8.35mm).
- The core is a conductive material so care should be taken when mounting this component over an exposed via or if the voltage across the terminals exceeds 24V. Trickle current through the core material may generate additional losses and potential overheating. Please contact Pulse to discuss an alternative solution if required.

SMT Power Inductor

Round Wire Coils - PG0926NL series



Mechanicals

Schematics

PG0926.XXXNL

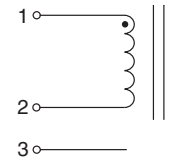
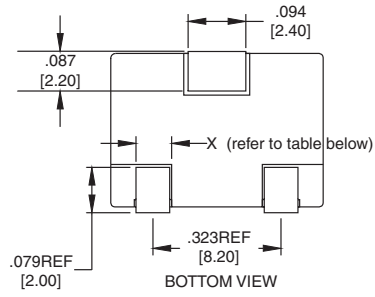
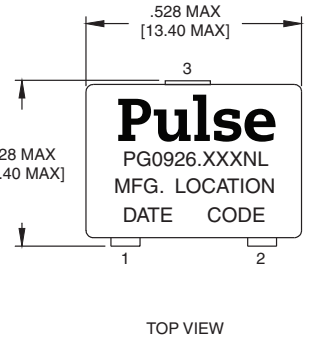
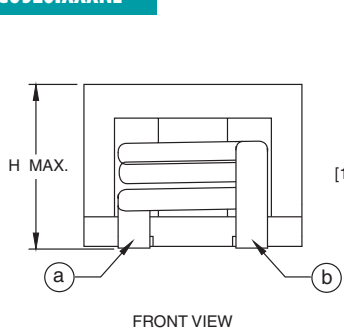

*Pin 3 is for mechanical support only and has no internal electrical connection

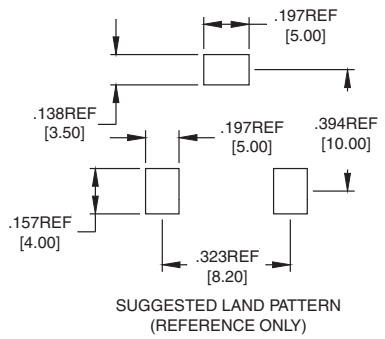

Weight.....4.5 grams
Tape and Reel.....300/reel

Dimensions: $\frac{\text{inched}}{\text{mm}}$

Unless otherwise specified, all tolerance are $\begin{matrix} +.010 \\ -.025 \end{matrix}$

PART NUMBER	X(Ref.)	H (HEIGHT)
PG0926.461NL	2.0mm	8.0mm
PG0926.102NL	2.0mm	
PG0926.182NL	2.0mm	
PG0926.282NL	2.0mm	
PG0926.562NL	2.0mm	
PG0926.722NL	1.6mm	
PG0926.872NL	1.6mm	7.9mm
PG0926.113NL	1.3mm	
PG0926.153NL	1.3mm	
PG0926.223NL	1.0mm	

Typical Inductance vs DC Bias

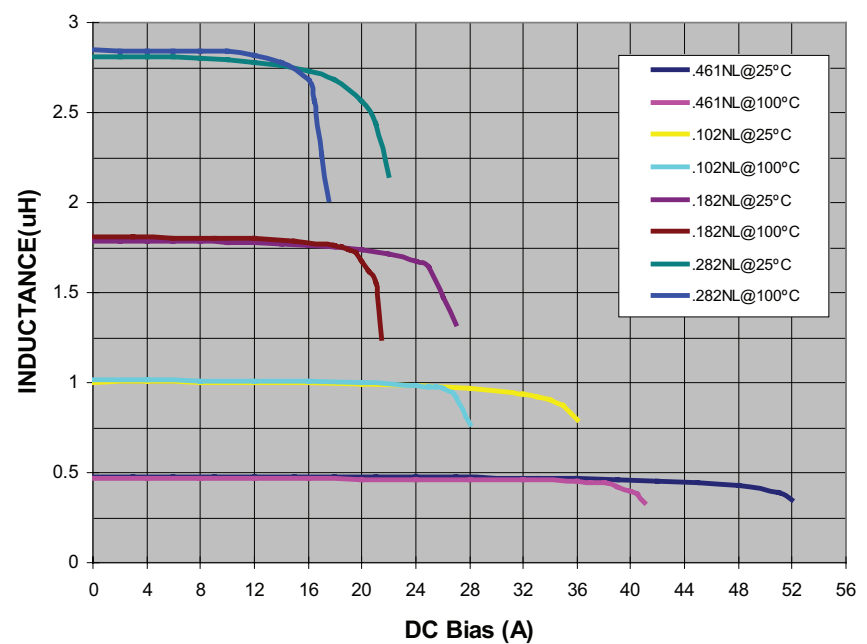

SMT Power Inductor

Round Wire Coils - PG0926NL series



Typical Inductance vs DC Bias

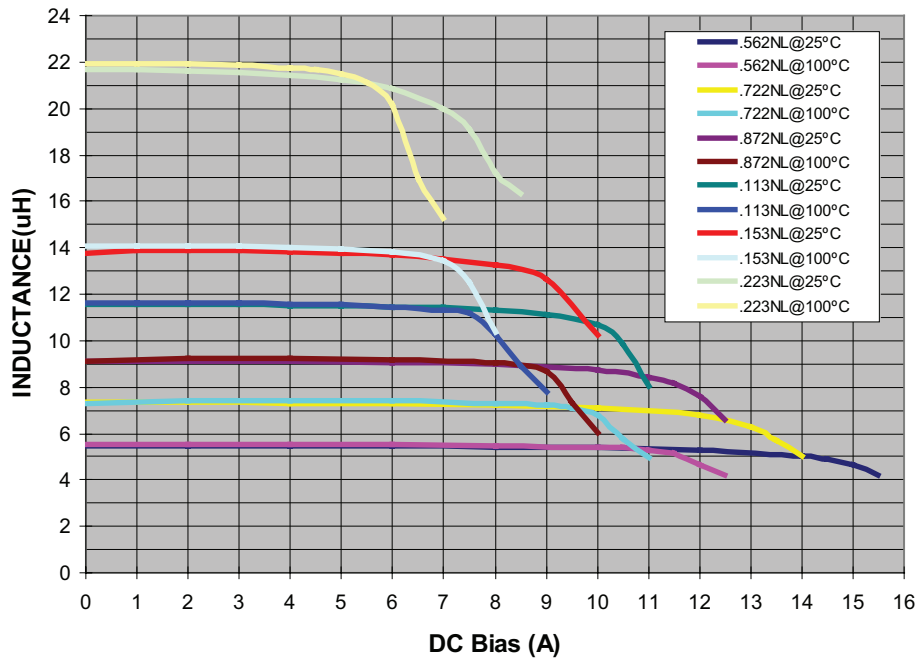

For More Information

Pulse Worldwide Headquarters

15255 Innovation Drive Ste 100
San Diego, CA 92128
U.S.A.

Pulse Europe

Pulse Electronics GmbH
Am Rottland 12
58540 Meinerzhagen
Germany

Pulse China Headquarters

Pulse Electronics (ShenZhen) CO., LTD
D708, Shenzhen Academy of
Aerospace Technology,
The 10th Keji South Road,
Nanshan District, Shenzhen, P.R.
China 518057

Pulse North China

Room 2704/2705
Super Ocean Finance Ctr.
2067 Yan An Road West
Shanghai 200336
China

Pulse South Asia

3 Fraser Street
0428 DUO Tower
Singapore 189352

Pulse North Asia

1F, No.111
Xiyuan Road
Zhongli District
Taoyuan City 32057
Taiwan (R.O.C)

Tel: 858 674 8100
Fax: 858 674 8262

Tel: 49 2354 777 100
Fax: 49 2354 777 168

Tel: 86 755 33966678
Fax: 86 755 33966700

Tel: 86 21 62787060
Fax: 86 2162786973

Tel: 65 6287 8998
Fax: 65 6280 0080

Tel: 886 3 4356768
Fax: 886 3 4356820

Performance warranty of products offered on this data sheet is limited to the parameters specified. Data is subject to change without notice. Other brand and product names mentioned herein may be trademarks or registered trademarks of their respective owners. © Copyright, 2019. Pulse Electronics, Inc. All rights reserved.