

AG940-07E

Digital / Analog / Omnipolar / Bipolar GMR Magnetic Sensor Evaluation Kit

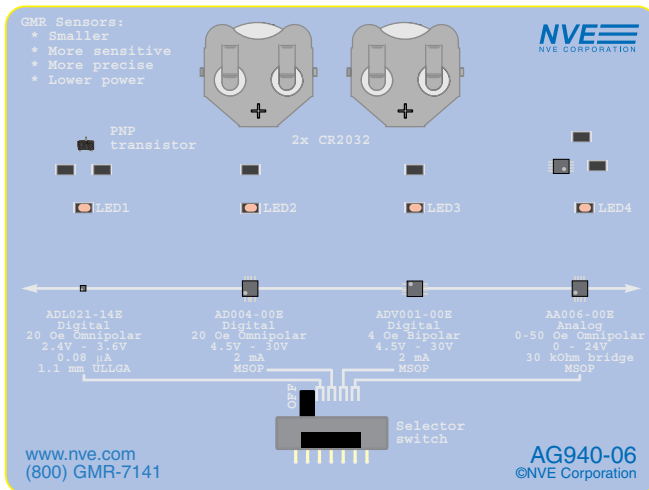

SB-00-051

Kit Overview

This kit contains:

- A battery-powered evaluation board with four of NVE's most popular GMR magnetic sensors driving indicator LEDs.
- A 0.5 x 0.25 x 0.125 inch (13 x 6 x 3 mm) Ceramic 8 bar magnet (NVE part no. 12030) to actuate the sensors.
- This manual.

	Part Number			
	ADL021-14E	AD004-00E	ADV001-00E	AA006-00E
Sensor Type	Digital	Digital	Digital	Analog
Sensing	20 Oe Omnipolar	20 Oe Omnipolar	4 Oe Bipolar	0 – 50 Oe Omnipolar
Supply Voltage	2.4 V – 3.6 V	4.5 V – 30 V	4.5 V – 30 V	0 – 24 V
Supply Current	0.08 μ A	2 mA	2 mA	0.03 mA/V (30 k Ω)
Package	1.1 x 1.1 mm ULLGA	MSOP	MSOP	MSOP

The sensors are examples of digital, analog, omnipolar, and bipolar types:

GMR Sensor Advantages

- Smaller
- More sensitive
- More precise
- Lower power

GMR Sensor Applications

- Proximity sensors
- Medical devices
- Current sensing

Quick Start

- ⇒ Set the slide switch to the sensor you wish to use.
- ⇒ Position the magnet horizontally over the selected sensor to activate.
- ⇒ Turn the power OFF when not in use to preserve the batteries.

Visit www.nve.com for product datasheets.

Sensor Operation

Magnet Orientation

Unlike most other magnetic sensors, GMR sensors are sensitive in the plane of the IC (rather than orthogonal to the IC) as shown in Figures 3a and 3b. This is more convenient for most applications. *Omnipolar* sensors are activated by either a North or South field. *Bipolar* sensors turn on with one field polarity and off with the other. Most GMR sensors are sensitive along the length of the sensor, but some (such as the ADV001) are cross-axis sensitive. Therefore the ADV001 sensor is rotated 90 degrees relative to the other sensors on the board.

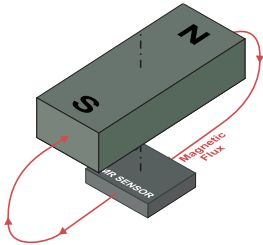

Fig. 3a. GMR sensitivity is in the IC plane.

This orientation activates bipolar sensors.

Either N-S orientation activates omnipolar sensors.

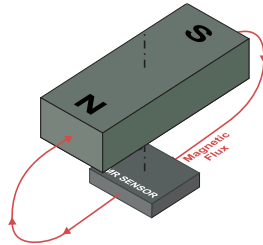

Fig. 3b. This orientation

deactivates bipolar sensors.

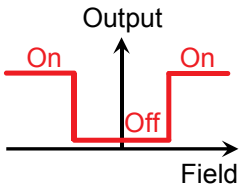

Fig. 4a. Digital omnipolar.

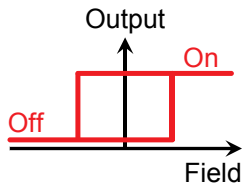

Fig. 4b. Digital bipolar.

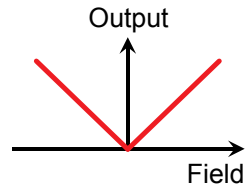

Fig. 4c. Analog omnipolar.

Magnetic Field and Distances

GMR sensors are quite sensitive, allowing large distances from the magnet.

The 0.5 x 0.25 inch (13 x 6 mm) low-cost ceramic magnet supplied with this demo provides 20 Oe to operate the ADL021, AD004, and AA006 from approximately 0.5 inches (13 mm). The 4 Oe ADV001 operates at more than an inch (25 mm). Larger or stronger magnets (such as Alnico or rare earth) operate even farther away, while smaller or weaker magnets need closer spacings.

With its extreme sensitivity, the ADV001 can be spuriously activated by a very close magnet due to remnant package magnetism. This is reversible—unlike some sensors, GMR sensors are not permanently affected by large fields.

Evaluation Board Schematic

Two 3-volt lithium coin cells power the evaluation board. The ADL021, which has a 2.4V to 3.6V supply range, is powered by one cell (3V nominal); the other sensors are powered by both cells in series (6V nominal).

The switch selects the sensor to be powered by connecting the selected sensor and associated circuitry to the power supply ground return.

Each of the sensors drive an LED to indicate the output. The AD004 and ADV001 sensors have high current drivers, so no external circuitry is required for the LED. The ADL021 low-power sensor has an external transistor to drive its LED.

The AA006 analog sensor drives an op-amp current-follower to vary the LED brightness proportionally to the sensor output. The current in LED4 is equal to the differential analog sensor output divided by R5. R6 provides a small negative sensor bias so the LED is fully off with no field, even if the sensor or op-amp have slight offset voltages.

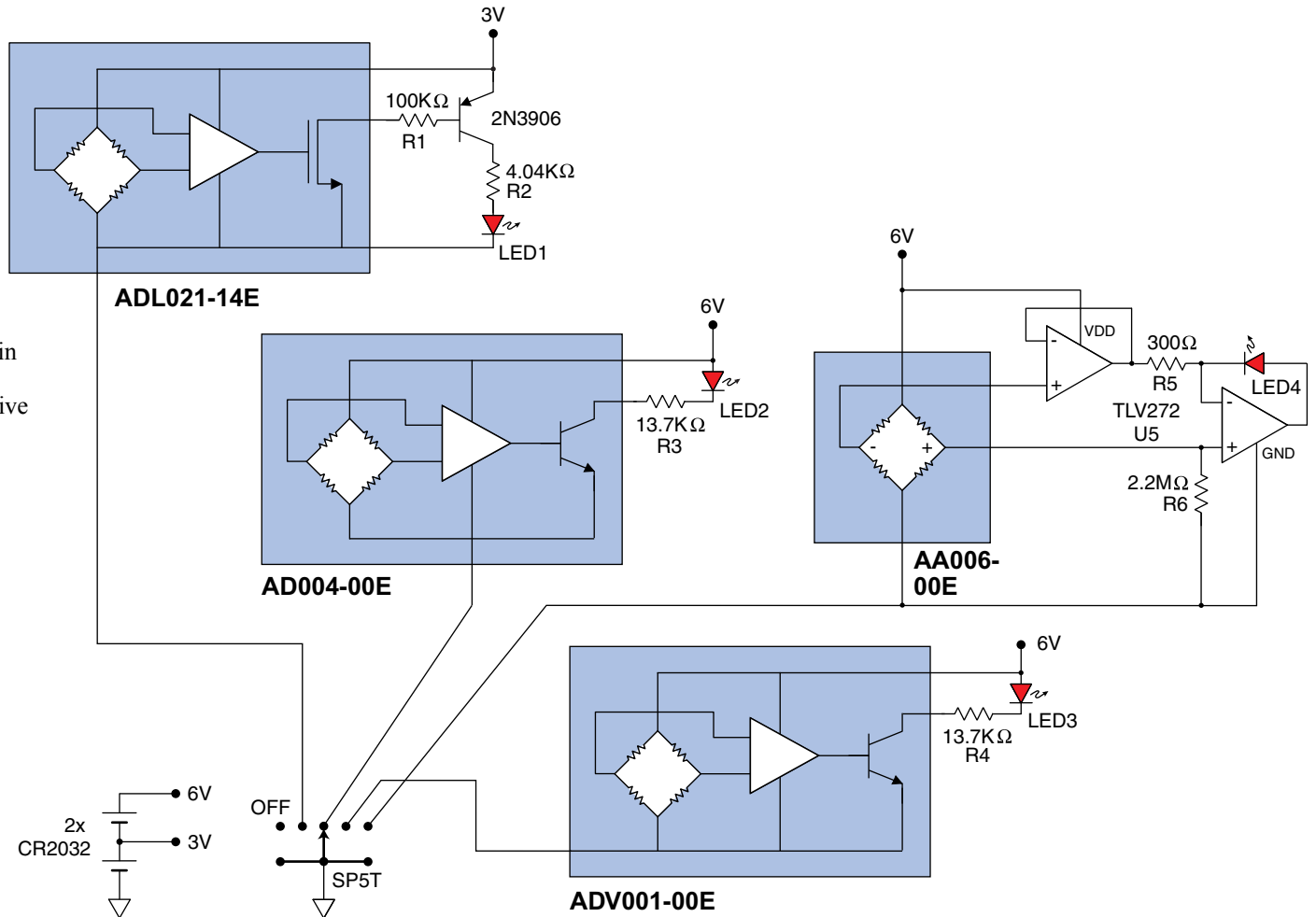

Board Layout

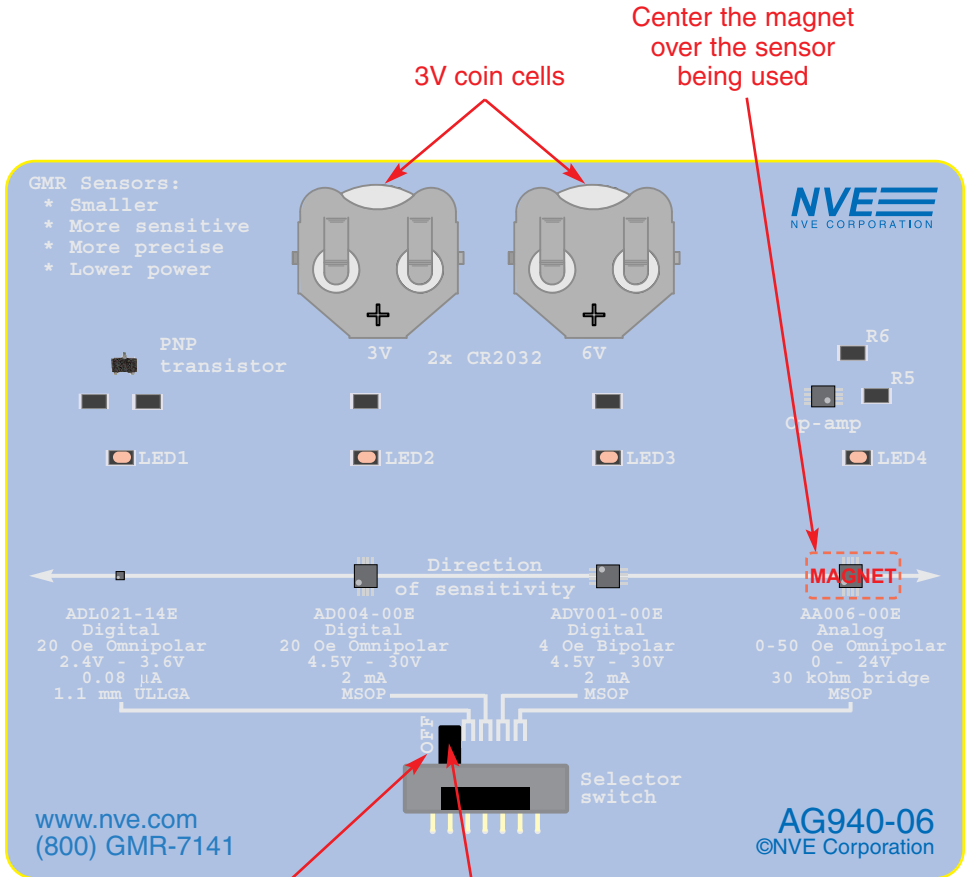

[actual size]

Turn switch
 "OFF" when
 not in use

Select
 desired sensor

Visit [YouTube.com/NveCorporation](https://www.youtube.com/NveCorporation) for a demonstration of this evaluation kit.

How GMR Works

Revolutionary Technology

The key to NVE's sensors is Giant Magnetoresistance (GMR), which produces a large change in resistance in response to a magnetic field. "Giant" refers to the very large output signals. GMR resistance depends on the relative magnetic alignment of the ferromagnetic pinned and free layers separated by a conducting, non-magnetic spacer (see Figure 1a):

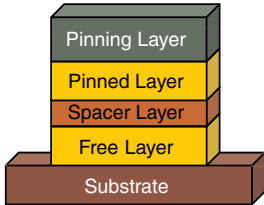

Fig. 1a. GMR Structure.

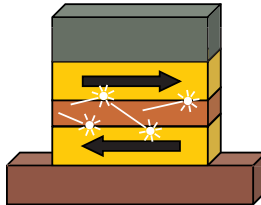

Fig. 1b. Anti-aligned magnetic moments (high resistance).

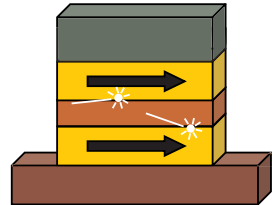

Fig. 1c. Aligned magnetic moments (low resistance).

The conducting spacer layer is typically less than two nanometers, or five atomic layers, thick.

Electrons scatter more frequently when their quantum spin differs from the magnetic orientation of the layer through which they are traveling, as in Figure 1b. If the magnetic moments of the ferromagnetic layers are aligned, as in Figure 1c, electron scattering is minimized and resistance is lowest. If the magnetic moments of the ferromagnetic layers are in opposing directions (anti-aligned), electron scattering is a maximum and resistance is highest.

Integrated Circuitry

NVE sensors are configured as Wheatstone bridges of GMR to increase sensitivity and cancel temperature variation. Digital sensors integrate GMR bridges with comparators. Ultralow power digital sensors (such as the ADL021 in this kit) add duty cycling and latching to minimize average power consumption.

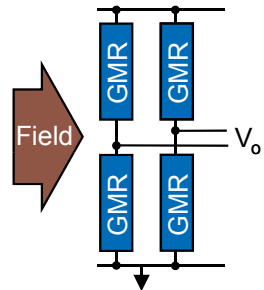

Fig. 2. Wheatstone bridge configuration.

Limited Warranty and Liability

Information in this document is believed to be accurate and reliable. However, NVE does not give any representations or warranties, expressed or implied, as to the accuracy or completeness of such information and shall have no liability for the consequences of use of such information. In no event shall NVE be liable for any indirect, incidental, punitive, special or consequential damages (including, without limitation, lost profits, lost savings, business interruption, costs related to the removal or replacement of any products or rework charges) whether or not such damages are based on tort (including negligence), warranty, breach of contract or any other legal theory.

Right to Make Changes

NVE reserves the right to make changes to information published in this document including, without limitation, specifications and product descriptions at any time and without notice.

Use in Life-Critical or Safety-Critical Applications

Unless NVE and a customer explicitly agree otherwise in writing, NVE products are not designed, authorized or warranted to be suitable for use in life support, life-critical or safety-critical devices or equipment. NVE accepts no liability for inclusion or use of NVE products in such applications and such inclusion or use is at the customer's own risk. Should the customer use NVE products for such application whether authorized by NVE or not, the customer shall indemnify and hold NVE harmless against all claims and damages.

Applications

Applications described in this document are illustrative only. NVE makes no representation or warranty that such applications will be suitable for the specified use without further testing or modification. Customers are responsible for the design and operation of their applications and products using NVE products, and NVE accepts no liability for any assistance with applications or customer product design. It is customer's sole responsibility to determine whether the NVE product is suitable and fit for the customer's applications and products planned, as well as for the planned application and use of customer's third party customers. Customers should provide appropriate design and operating safeguards to minimize the risks associated with their applications and products. NVE does not accept any liability related to any default, damage, costs or problem which is based on any weakness or default in the customer's applications or products, or the application or use by customer's third party customers. The customer is responsible for all necessary testing for the customer's applications and products using NVE products in order to avoid a default of the applications and the products or of the application or use by customer's third party customers. NVE accepts no liability in this respect.

An ISO 9001 Certified Company

NVE Corporation
11409 Valley View Road
Eden Prairie, MN 55344-3617

©NVE Corporation

All rights are reserved. Reproduction in whole or in part is prohibited without the prior written consent of the copyright owner.

Manual No.: SB-00-051