

**NOTE:** Use Wire With Stranded Conductors Only.

WIRE SIZE (AWG)	PART NUMBERS			TERMINAL HOUSING COLOR
	CRIMPING DIE ASSEMBLY	TERMINALS		
		STRIP	LOOSE-PIECE	
10	224027-1	4-520447-2	4-520448-2	Yellow
12	224027-2	4-520447-2	4-520448-2	Yellow

Figure 1

## 1. INTRODUCTION

This instruction sheet covers the use of Crimping Die Assemblies 224027-1 and -2 which are designed for use in 626 Pneumatic Tooling Assemblies to crimp the Ultra-Fast Fully Insulated FASTON\* receptacle terminals listed in Figure 1.

**NOTE** All dimensions on this instruction sheet are in metric units [with U.S. customary units in brackets].

**NOTE** This die assembly requires Adapter Holder 189928-1 and Straight Action Crimper 217200-1 to operate in the 626 Pneumatic Tooling System.

This sheet also covers terminal and wire specifications, maintenance and inspection procedures, and general performance of the crimping die assemblies. Read customer manual 409-5862,

packaged with the pneumatic tool, for information concerning die assembly installation and general performance of the pneumatic tool.

Reasons for reissue are provided in Section 7, REVISION SUMMARY.

## 2. DESCRIPTION

Each die assembly consists of a stationary die (anvil) and a moving die indenter. The stationary die features a die holding screw, applicable wire size markings, and the part number of the die assembly. The moving die features a die holding screw, the part number of the die assembly, and "Ultra-Fast" marking for the type of terminal it is designed to crimp.

A terminal locator/stop (locator) is an integral part of each die assembly. The locator is designed to serve as a terminal stop, positioning the terminal properly between the dies for crimping.

### 3. INSTALLATION AND REMOVAL OF STRAIGHT ACTION CRIMPER (Figure 1)

Before installing the straight action crimper, refer to customer manual 409-5862 for instructions on installing the appropriate tool holder assembly (including cam) on the pneumatic tool. After the appropriate tool holder assembly has been installed, proceed as follows:

**NOTE**  Removal is the reverse of installation.

**DANGER**  To prevent personal injury, ALWAYS disconnect the main air supply and electrical supply (if applicable) of the pneumatic tool before installing or removing the straight action crimper.

**DANGER**  DO NOT operate pneumatic tool without the straight action crimper and the proper die assembly installed. After straight action crimper is installed, make sure that the quick pins are FULLY tightened to avoid personal injury and damage to the tool.

1. Remove quick pins from tool holder assembly. Refer to Figure 1, a typical instruction sheet 408-4105.
2. Slide the straight action crimper into tool holder assembly, aligning the threaded holes on the crimper with the threaded quick pin holes on the holder.
3. After crimper is properly aligned in the tool holder assembly, insert and tighten the quick pins.

**NOTE**  TE Connectivity recommends using Loctite† No. 242 removable threadlock, or equivalent, to prevent the quick pins from loosening.

### 4. CRIMPING PROCEDURES

Refer to the table in Figure 1 and check the selected wire, loose-piece terminal, and crimping die assembly for compatibility. Strip the wire to the length indicated — do NOT cut or nick the wire strands.

Install the die assembly, position terminal and wire, and perform the crimping procedure as instructed in 409-5862, packaged with 626 Pneumatic Tool.

Make certain all surfaces of the dies are protected with a THIN coat of any good SAE 20 motor oil. Do NOT oil excessively.

† Trademark of Loctite Corporation

### 5. MAINTENANCE AND INSPECTION

**DANGER**  To avoid personal injury, ALWAYS disconnect air supply from pneumatic tool before performing maintenance or inspection.

TE recommends that a maintenance and inspection program be performed periodically to ensure dependable and uniform terminations.

Frequency of inspection should be adjusted to suit your requirements through experience. Frequency of inspection depends on:

1. The care, amount of use, and handling of the crimping head.
2. The type and size of the product crimped.
3. The degree of operator skill.
4. The presence of abnormal amounts of dust and dirt.
5. Your own established standards.

Each die assembly is thoroughly inspected before packaging. Since there is a possibility of damage during shipment, new die assemblies should be inspected immediately upon arrival at your facility.

#### 5.1. Daily Maintenance

It is recommended that each operator of the dies be made aware of — and responsible for — the following three steps of daily maintenance:

1. Remove dust, dirt, and other contaminants with a clean brush, or a soft, lint-free cloth. Do NOT use objects that could damage the dies.
2. Make certain the dies are protected with a THIN coat of any good SAE 20 motor oil. Do NOT oil excessively.
3. When the dies are not in use, mate them and store in a clean, dry area.

#### 5.2. Periodic Inspection

Regular inspections should be performed by quality control personnel. A record of scheduled inspections should remain with the dies and/or be supplied to supervisory personnel responsible for the dies. Though recommendations call for at least one inspection a month, the inspection frequency should be based on the amount of use, ambient working conditions, operator training and skill, and established company standards. These inspections should be performed in the following sequence:

#### 5.3. Visual Inspection

1. Remove all lubrication and accumulated film by immersing the dies in a suitable commercial degreaser that will not affect paint or plastic material.

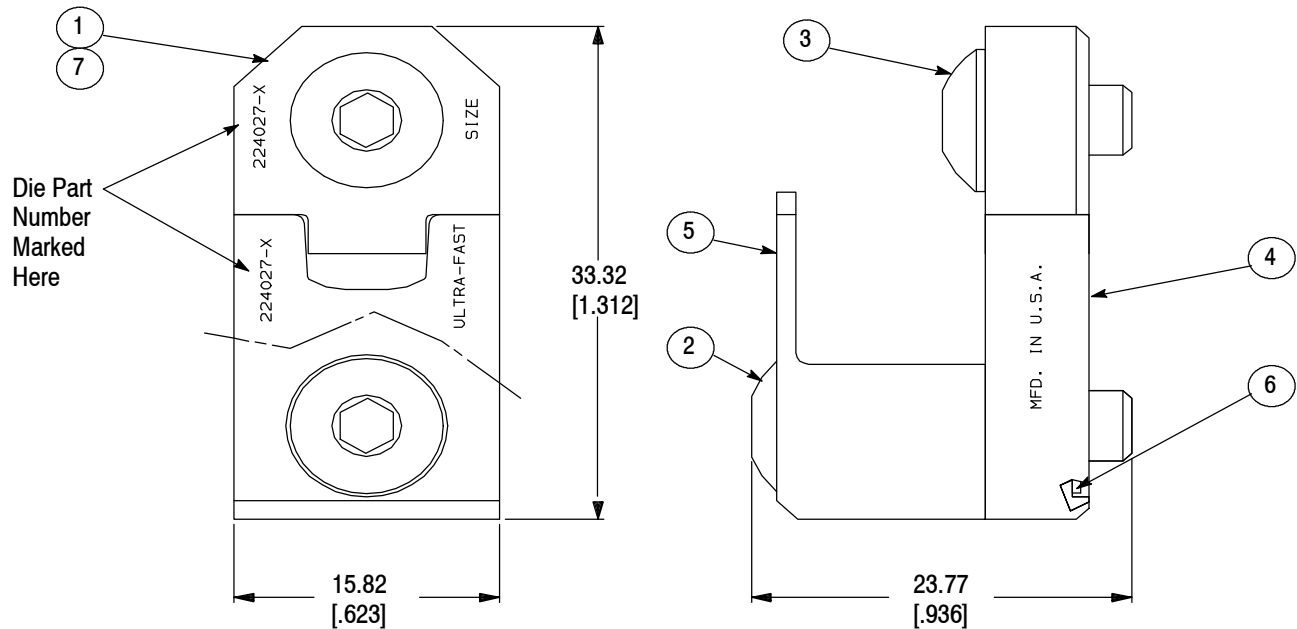

WEIGHT (Per Assembly)	REPLACEMENT PARTS			
	ITEM NO.	PART NO.	DESCRIPTION	QTY PER ASSY
43 g [1.5 oz.] (Approximate)	1	313350-1	ANVIL, For Die Assembly, 224027-1	1
	2	2-306131-2	SCREW, Die Holding	1
	3	306592-3	SCREW	1
	4	313351-1	INDENTER	1
	5	313352-1	LOCATOR	1
	6	1-21046-3	RING, Retaining	2
	7	313350-2	ANVIL, For Die Assembly 224027-2	1

Figure 2

2. Make sure all die holding screws, retaining rings, and die components are in place. Refer to the parts listed in Figure 2 if replacements are necessary.

3. Check components for wear. Remove and replace worn components.

4. Inspect the crimp area for flattened, chipped, cracked, worn, or broken areas. If damage is evident, the dies must be repaired before returning them to service (see Section 6, REPLACEMENT AND REPAIR).

### 5.4. Gaging the Crimped Chamber

This inspection requires the use of a plug gage conforming to the diameters shown in Figure 3. TE does not manufacture or market these gages.



*Disconnect air supply and remove adapter holder and straight action crimper, with dies, from tooling assembly.*

1. Mate the dies until it is evident that they have bottomed. Hold the dies in this position.

2. Align the GO element with the appropriate crimping chamber. Push element straight into the crimping chamber without using force. The GO element must pass completely through the crimping chamber as shown in Figure 3.

3. Now align the NO-GO element and try to insert it straight into the same crimping chamber. The NO-GO element may start entry but must not pass completely through as shown in Figure 3.

If the crimping chamber conforms to the gage inspection, the dies are considered dimensionally correct and should be lubricated with a THIN coat of SAE 20 motor oil. If not, the dies must be repaired

before returning them to service (see Section 6, REPLACEMENT AND REPAIR).

For additional information concerning the use of a plug gage, refer to instruction sheet 408-7424.

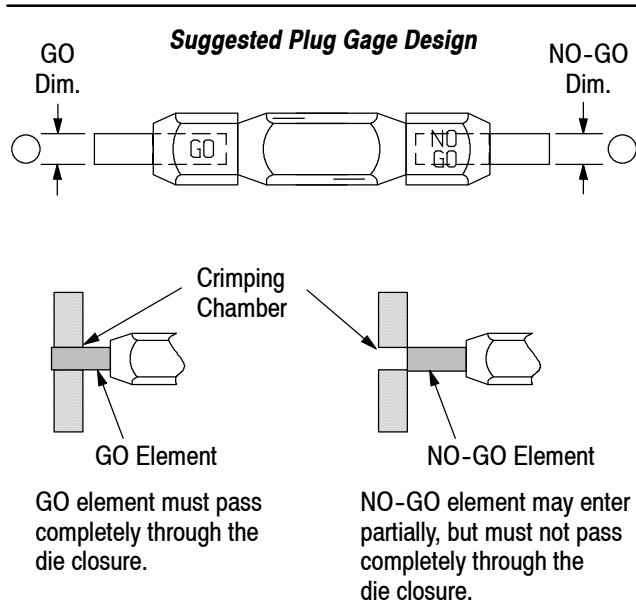

DIE ASSEMBLY PART NUMBER	ELEMENT DIAMETER	
	GO	NO-GO
224027-1	2.464 [.0970]	2.616 [.1030]
224027-2	2.337 [.0920]	2.489 [.0980]

Figure 3

## 6. REPLACEMENT AND REPAIR

Replacement parts are listed in Figure 2. Parts other than those listed in Figure 2 should be replaced by TE to ensure quality and reliability of the tool. Order replacement parts through your TE Representative, or call 1-800-526-5142, or send a facsimile of your purchase order to 1-717-986-7605, or write to:

CUSTOMER SERVICE (038-035)  
 TYCO ELECTRONICS CORPORATION  
 P.O. BOX 3608  
 HARRISBURG, PA 17105-3608

For tool repair service, please contact a TE Representative at 1-800-526-5136.

## 7. REVISION SUMMARY

Since the previous release of this sheet, the following changes were made:

- Updated document to corporate requirements.