

# SPECIFICATION

## Patent Pending

- Part Number : **FXP611.07.0092C**
- Product Name : "The Cloud" Flexible Polymer  
GPS/GLONASS/GALILEO/BeiDou  
Cloud Shape Antenna
- Features : 1559-1610 MHz  
38mm\*37mm\*0.15mm size  
92mm Cable  
IPEX MHFI Connector (U.FL compatible)  
**RoHS Compliant**



## **1. Introduction**

This convenient “peel and stick” flexible polymer antenna is designed for applications which require high positioning accuracy using GPS, GLONASS, Galileo and even BeiDou functions on modern day GNSS systems. The antenna is designed to be mounted directly to plastic (e.g. ABS enclosure of a wireless device) and has been designed in a way that makes it extremely resistant to detuning affects caused by the device environment.

## 2. Specification

ELECTRICAL	
ANTENNA	GPS-GLONASS-GALILEO-BeiDou
STANDARD	
Operation Frequency (MHz)	1559-1610
Polarization	Linear
Impedance (Ohms)	50
Max VSWR	1.2:1
Peak Gain (dBi)	3
Efficiency (%)	80
Average Gain (dB)	-1
Radiation Properties	Omni-directional
Max Input Power (Watts)	5

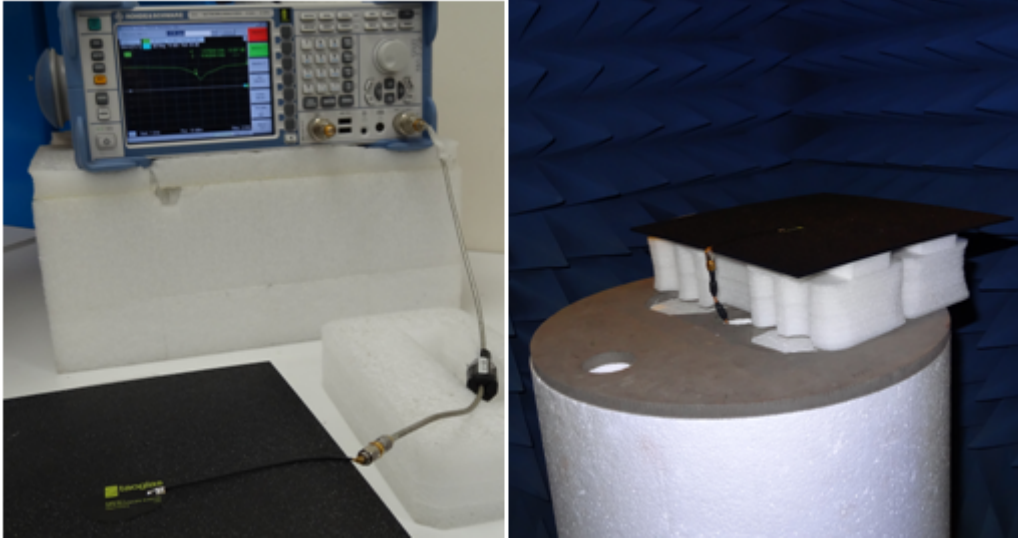
\* The FXP611 antenna performance was measured with 30X30 cm ABS Plastic.

MECHANICAL	
Antenna	GPS-GLONASS-GALILEO-BeiDou
Standard	
Dimensions (mm)	38x37x0.15
Required Space (mm)	40x40x0.2
Material	Flexible Polymer
Connector	MHFI(U.FL Compatible)
Weight(g)	0.9

\*\* The FXP611 antenna requires at least 1cm clearance to metal or to the main device ground plane

ENVIRONMENTAL	
Antenna	GPS-GLONASS-GALILEO-BeiDou
Standard	
Operation Temperature	-40°C to 85°C
Storage Temperature	-40°C to 105°C
Relative Humidity	40% to 95%
RoHS Compliant	Yes

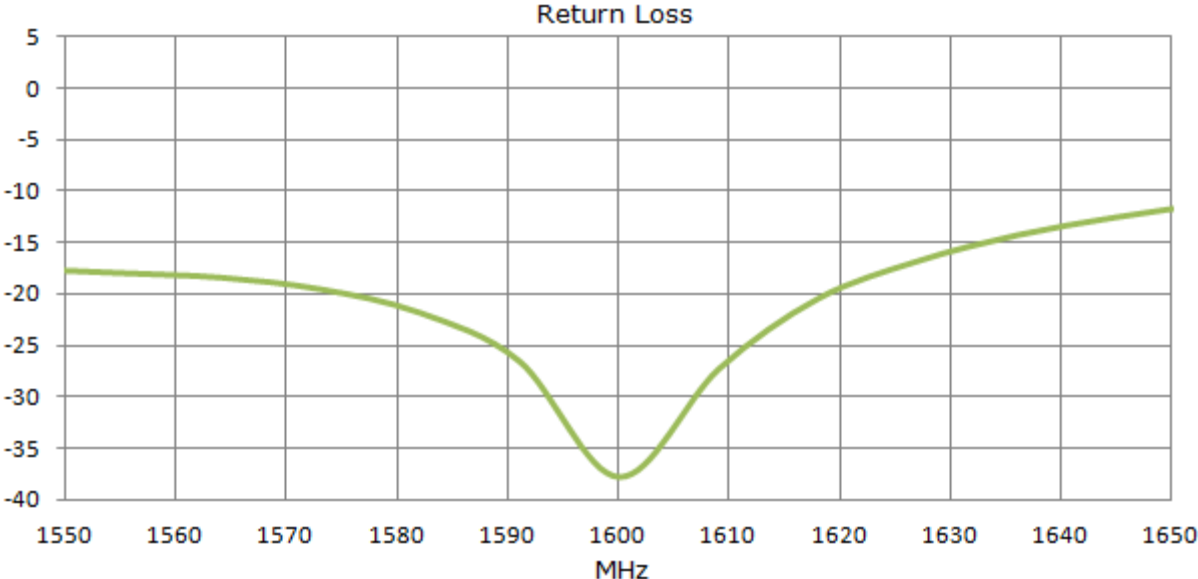
### 3. Test Setup



**Figure 1:** Impedance, isolation and correlation coefficient measurements (left hand) and peak gain, average gain, efficiency and radiation pattern measurements (right hand)

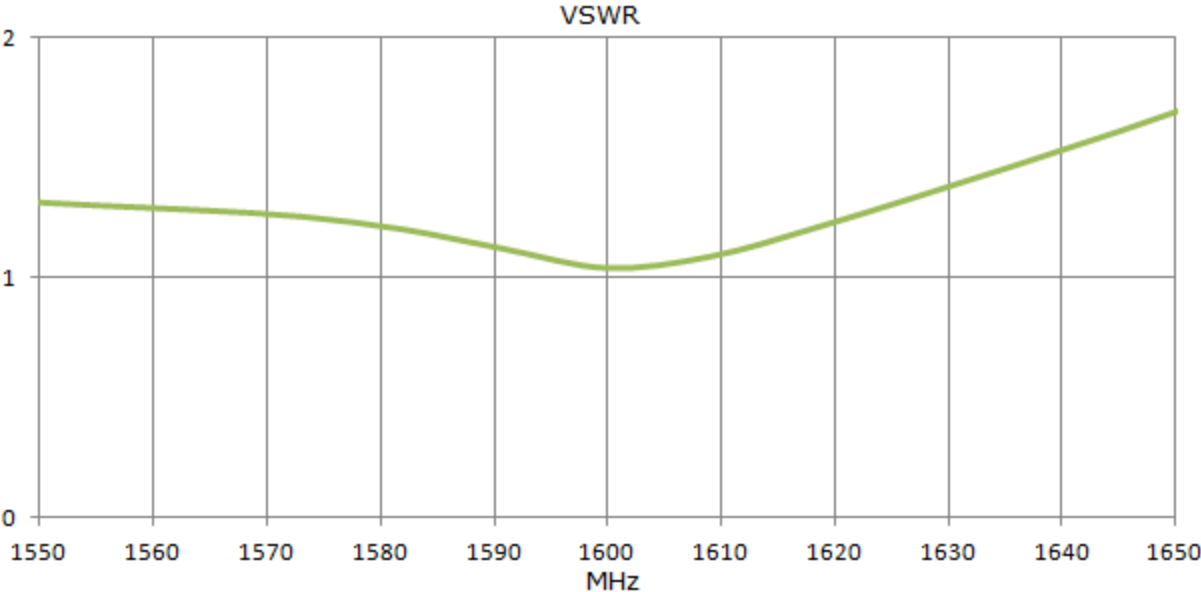
# 4. Antenna Parameters

## 4.1. Return Loss



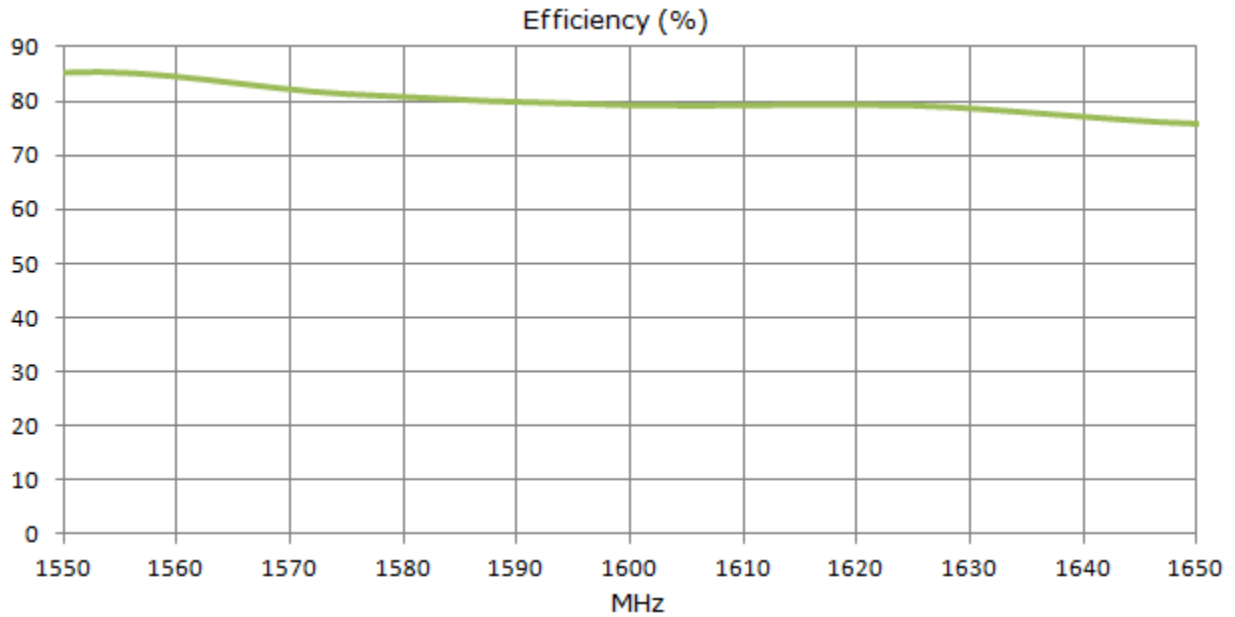
**Figure 2:** Return loss of FXP611 GPS/GLONASS/GALILEO/BeiDou Antenna

## 4.2. VSWR



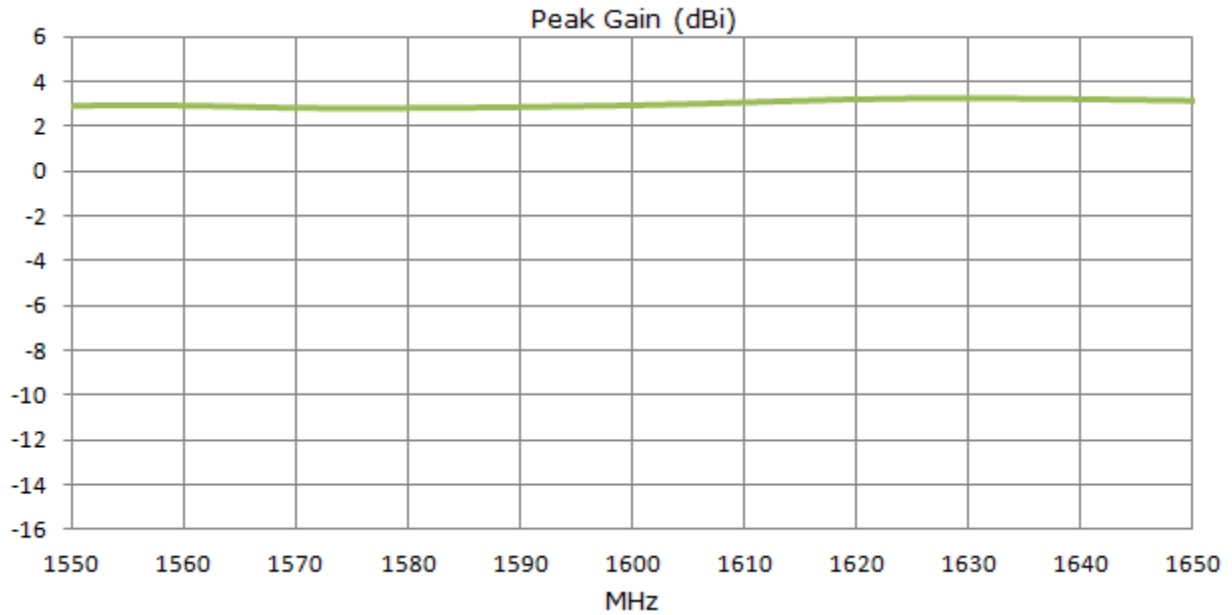
**Figure 3:** VSWR of FXP611 GPS/GLONASS/GALILEO/BeiDou Antenna

### 4.3. Efficiency



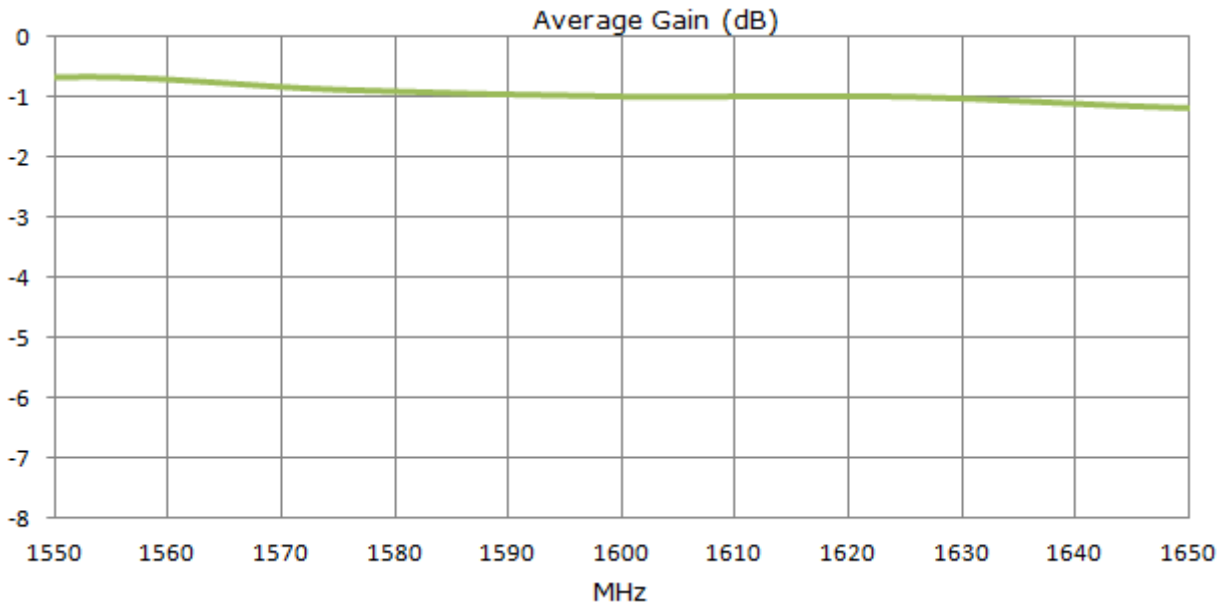
**Figure 4:** Efficiency of FXP611 GPS/GLONASS/GALILEO/BeiDou Antenna

### 4.4. Peak Gain



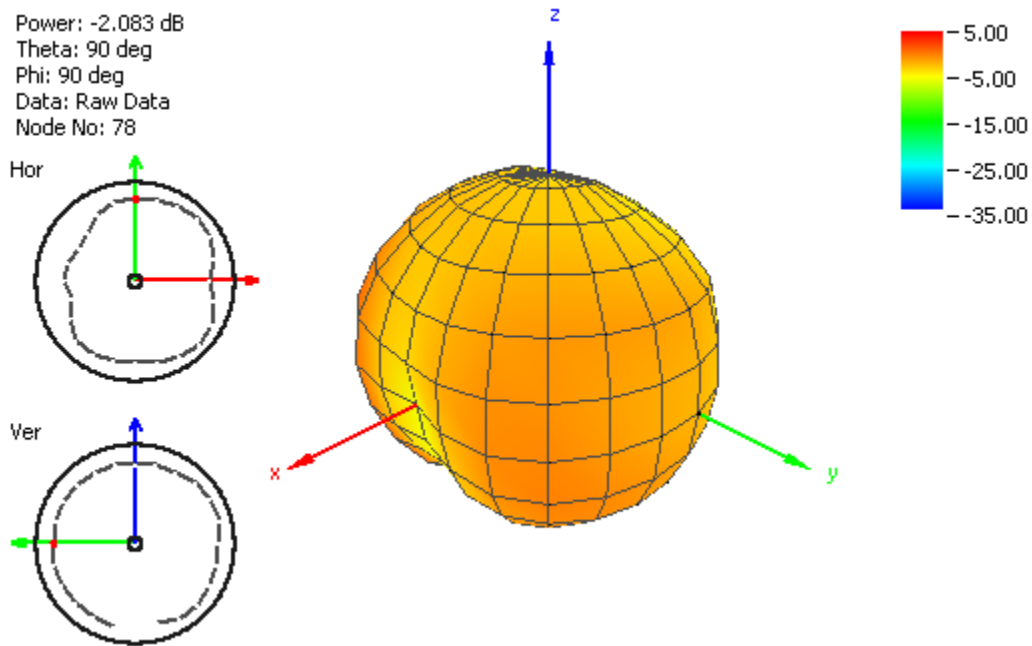
**Figure 5:** Peak Gain of FXP611 GPS/GLONASS/GALILEO/BeiDou Antenna

## 4.5. Average Gain

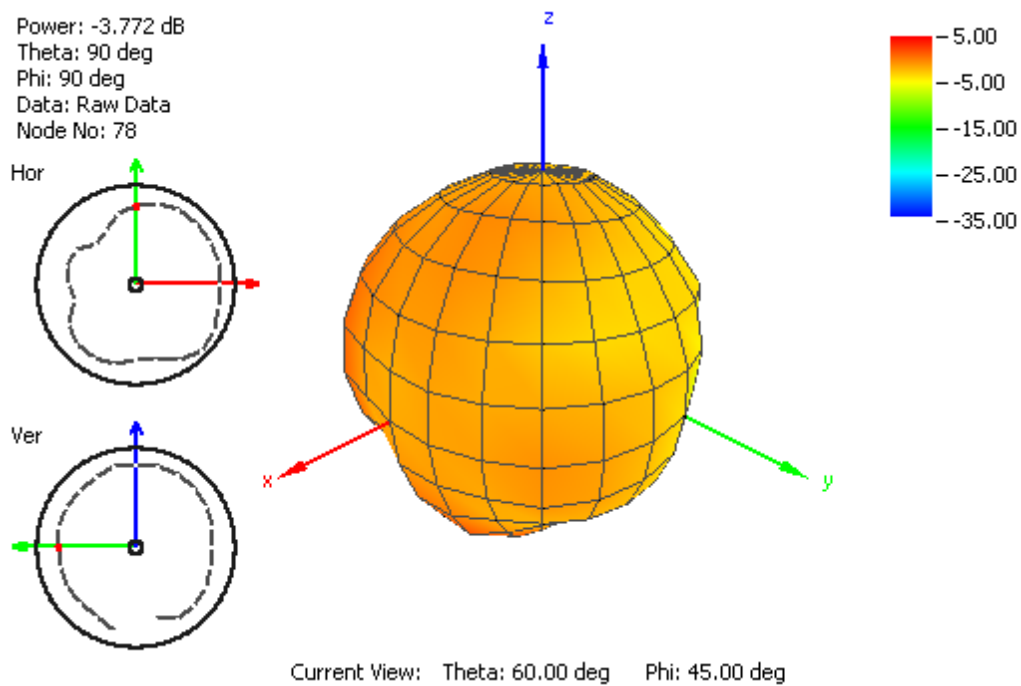


**Figure 6:** Average Gain of FXP611 GPS/GLONASS/GALILEO/BeiDou Antenna

## 4.6. Radiation Pattern

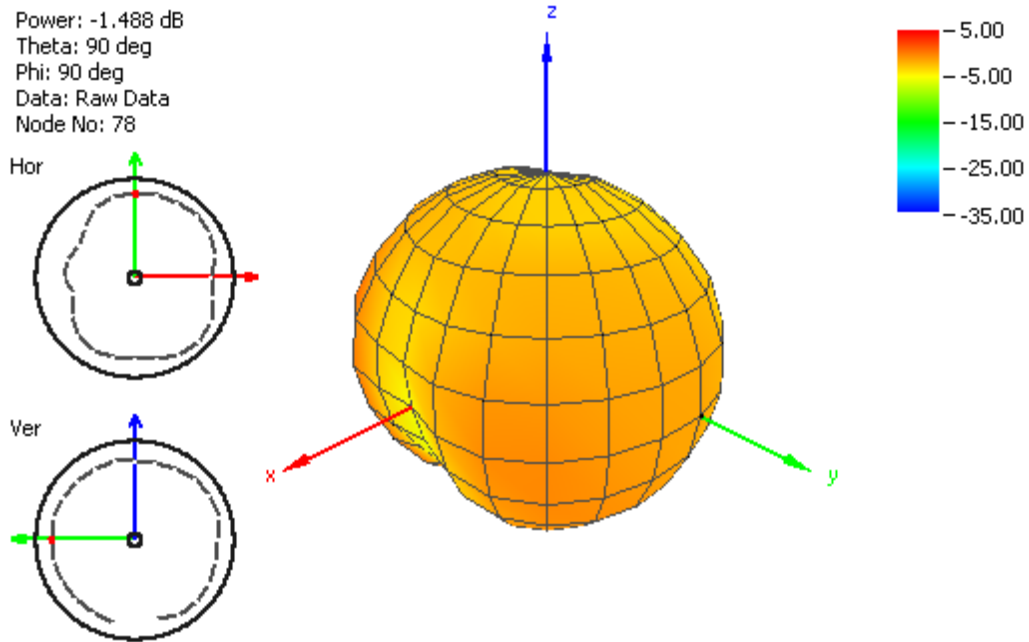


**Figure 7:** Radiation Pattern of FXP611 GPS/GLONASS/GALILEO/BeiDou Antenna at 1561MHz

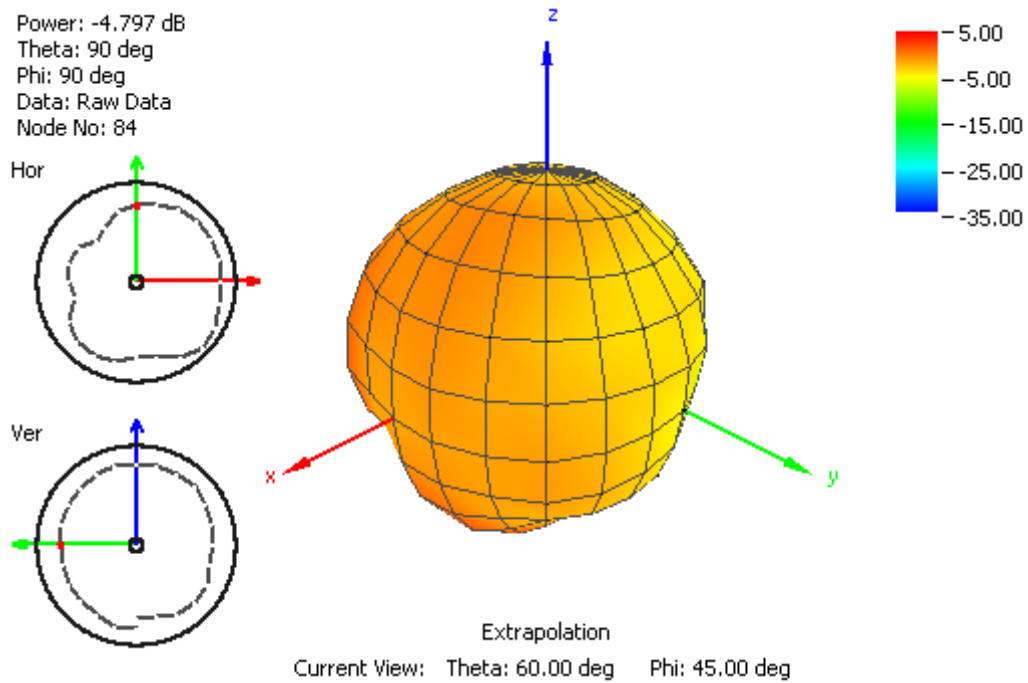


**Figure 8:** Radiation Pattern of FXP611 GPS/GLONASS/GALILEO/BeiDou Antenna at 1575MHz



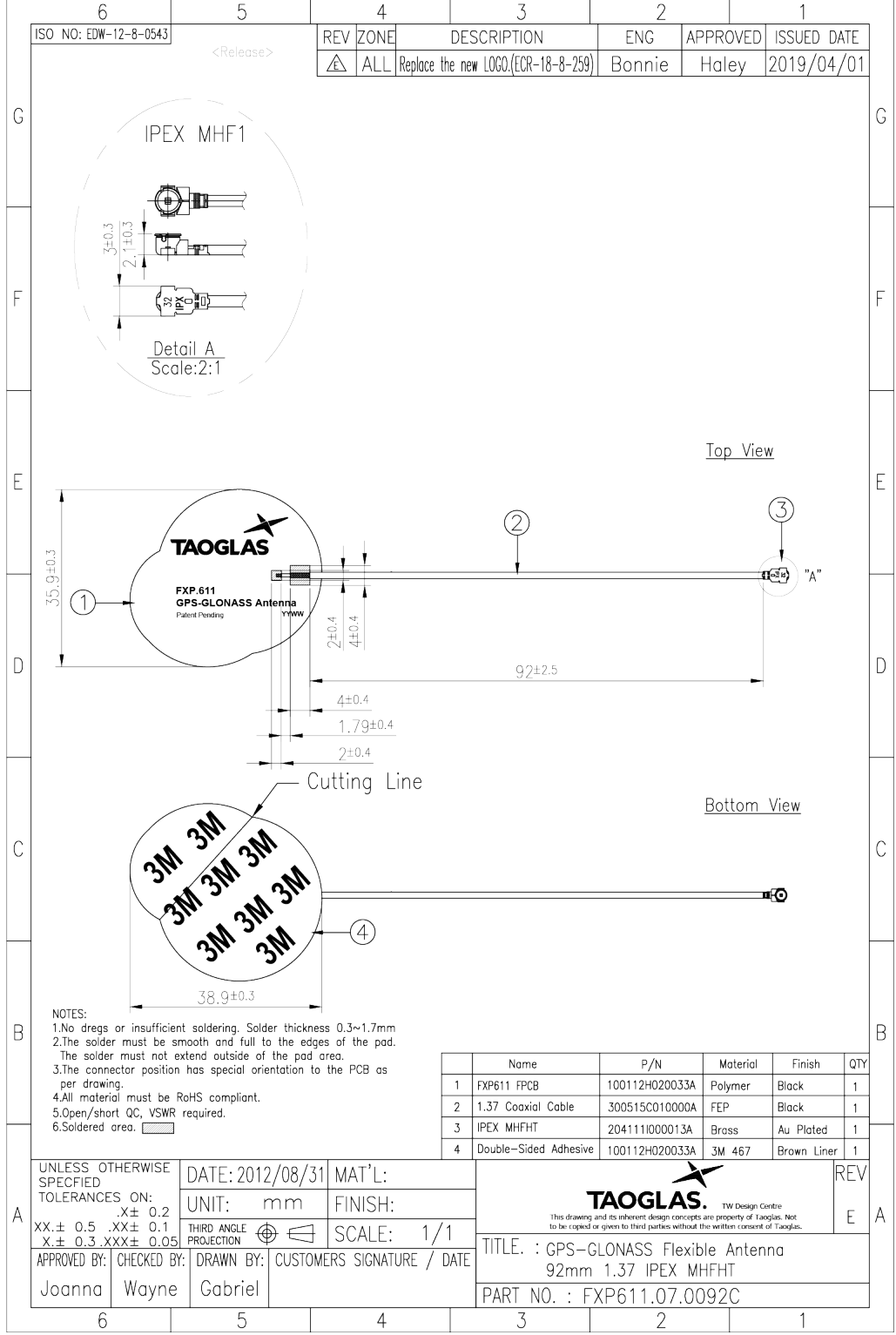


**Figure 9:** Radiation Pattern of FXP611 GPS/GLONASS/GALILEO/BeiDou Antenna at 1589MHz



**Figure 10:** Radiation Pattern of FXP611 GPS/GLONASS/GALILEO/BeiDou Antenna at 1610MHz

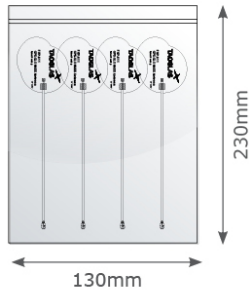
# 5. Mechanical Drawing



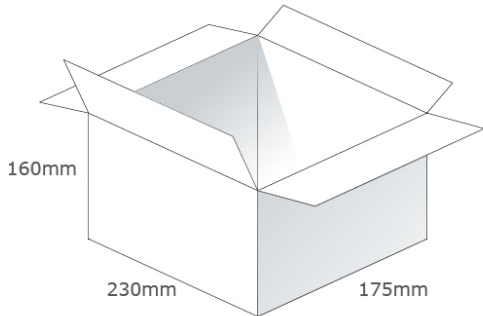
# 6. Packaging



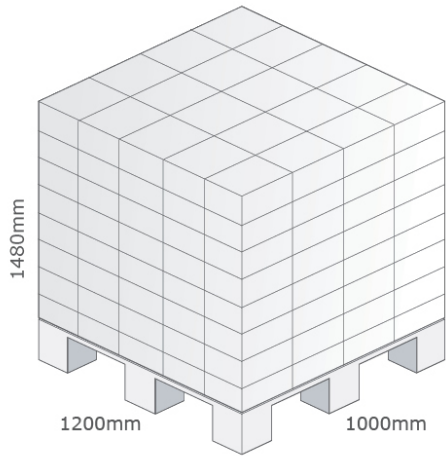
100pcs FXP611.07.0092C per PE Bag  
 Bag Dimensions - 130 x 230mm  
 Weight - 132g



2,000 pcs FXP611.07.0092C per carton  
 Carton - 230 x 175 x 160mm  
 Weight - 2.8Kg



Pallet Dimensions 1200 x 1000 x 1480mm  
 200 Cartons per Pallet  
 25 Cartons per layer  
 8 Layers



Taoglas makes no warranties based on the accuracy or completeness of the contents of this document and reserves the right to make changes to specifications and product descriptions at any time without notice. Taoglas reserves all rights to this document and the information contained herein.

Reproduction, use or disclosure to third parties without express permission is strictly prohibited.

© Taoglas