

LINDA-WWW

~110° + 100° wide beam

SPECIFICATION:

Dimensions	25.7 x 1140.0 mm
Height	6.3 mm
ROHS compliant	yes ⓘ

MATERIALS:

Component	Type	Material	Colour	Finish
LINDA-WWW	Linear lens	PMMA	milky	

ORDERING INFORMATION:

Component	Qty in box	MOQ	MPQ	Box weight (kg)
F16747_LINDA-WWW » Box size: 1185 x 150 x 115 mm	130	130	130	11.4



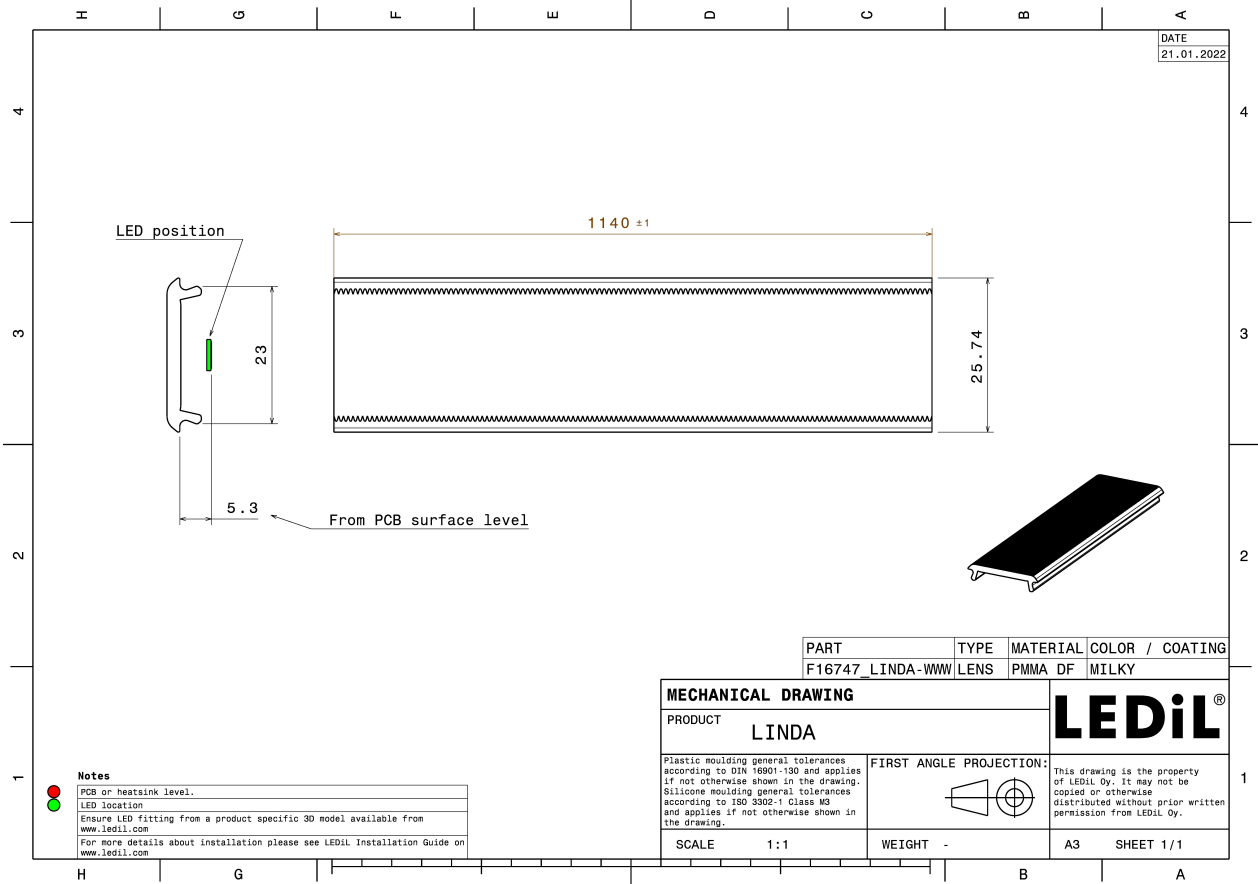

See also our general installation guide: www.ledil.com/installation_guide

OPTICAL RESULTS (MEASURED):

CITIZEN

LED CLUC11
 FWHM / FWTM 103.0 + 107.0° / 156.0 + 152.0°
 Efficiency 87 %
 Peak intensity 0.3 cd/lm
 LEDs/each optic 1
 Light colour White
 Required components:

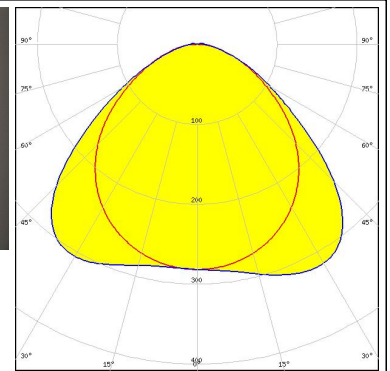
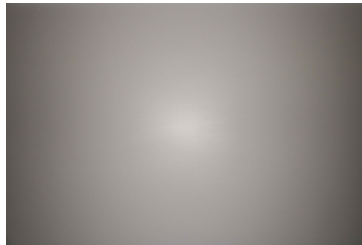

CREE LED

LED XP-G3
 FWHM / FWTM 114.0 + 117.0° / 167.0 + 173.0°
 Efficiency 86 %
 Peak intensity 0.3 cd/lm
 LEDs/each optic 1
 Light colour White
 Required components:

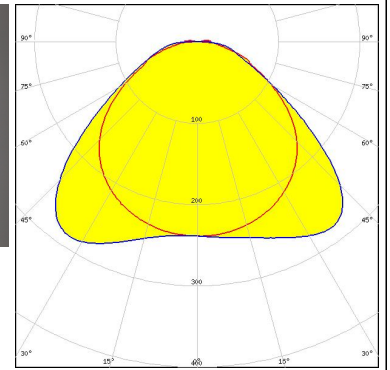

NICHIA

LED NF2W757G-MT (Tunable White)
 FWHM / FWTM 104.0 + 106.0° / 158.0 + 152.0°
 Efficiency 90 %
 Peak intensity 0.3 cd/lm
 LEDs/each optic 1
 Light colour Tunable White
 Required components:

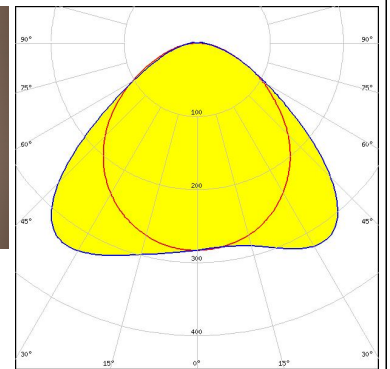
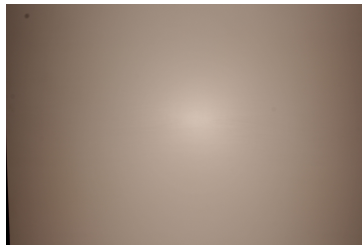

NICHIA

LED NFSW757H
 FWHM / FWTM 103.0 + 105.0° / 158.0 + 151.0°
 Efficiency 90 %
 Peak intensity 0.3 cd/lm
 LEDs/each optic 1
 Light colour White
 Required components:

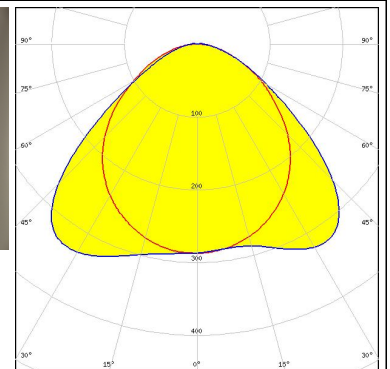

OPTICAL RESULTS (MEASURED):

OSRAM

LED PL-LIN-Z5 1100 280x20
 FWHM / FWTM 105.0 + 103.0° / 159.0 + 146.0°
 Efficiency 86 %
 Peak intensity 0.3 cd/lm
 LEDs/each optic 1
 Light colour White
 Required components:

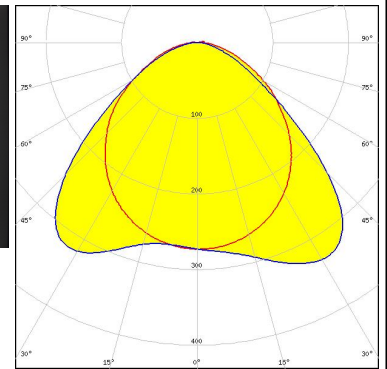

OSRAM

LED PL-LIN-Z5 2000 280x20
 FWHM / FWTM 105.0 + 103.0° / 159.0 + 145.0°
 Efficiency 83 %
 Peak intensity 0.3 cd/lm
 LEDs/each optic 1
 Light colour White
 Required components:

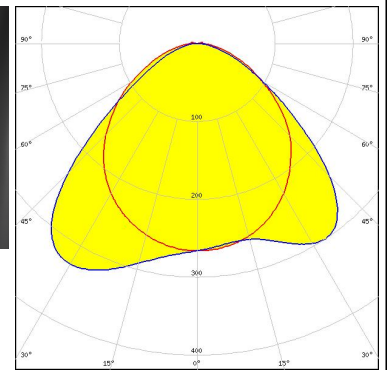
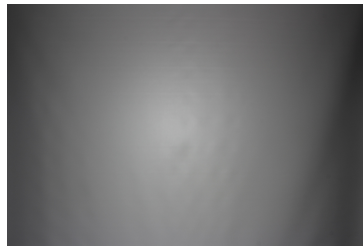

OSRAM

Opto Semiconductors

LED Duris E 2835
 FWHM / FWTM 105.0 + 103.0° / 159.0 + 146.0°
 Efficiency 86 %
 Peak intensity 0.3 cd/lm
 LEDs/each optic 1
 Light colour White
 Required components:

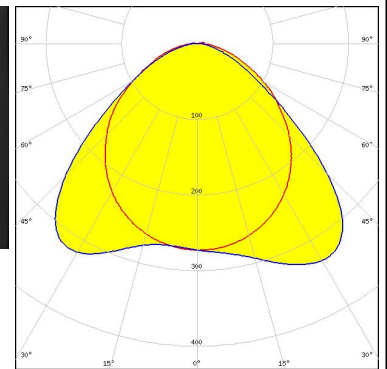
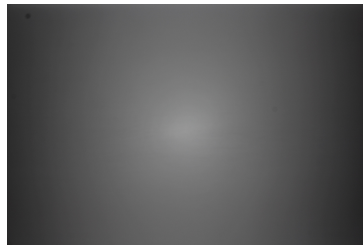

OSRAM

Opto Semiconductors

LED Duris E 2835
 FWHM / FWTM 104.0 + 106.0° / 159.0 + 152.0°
 Efficiency 91 %
 Peak intensity 0.3 cd/lm
 LEDs/each optic 1
 Light colour White
 Required components:

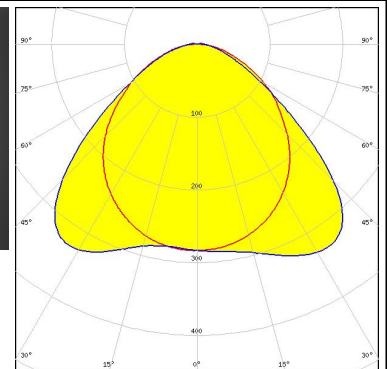

OPTICAL RESULTS (MEASURED):

OSRAM

Opto Semiconductors

LED Duris E 2835
 FWHM / FWTM 105.0 + 103.0° / 159.0 + 145.0°
 Efficiency 83 %
 Peak intensity 0.3 cd/lm
 LEDs/each optic 1
 Light colour White
 Required components:

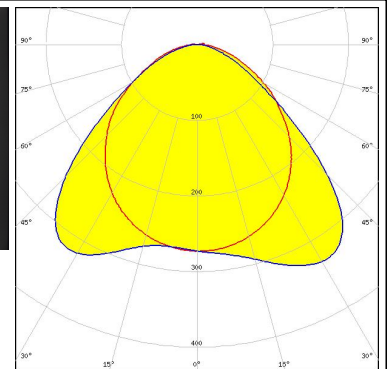

PHILIPS

LED Fortimo LED Strip 1ft 1100lm FC HV4 & LV4
 FWHM / FWTM 103.0 + 105.0° / 157.0 + 147.0°
 Efficiency 85 %
 Peak intensity 0.3 cd/lm
 LEDs/each optic 1
 Light colour White
 Required components:

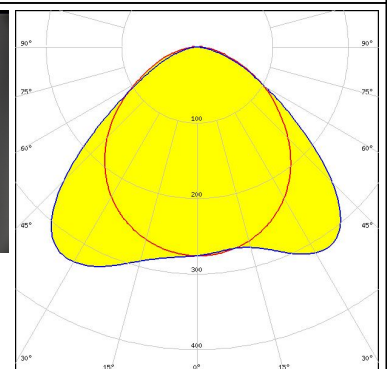

PHILIPS

LED Fortimo LED Strip 1ft 1100lm FC HV5 & LV5
 FWHM / FWTM 105.0 + 108.0° / 159.0 + 157.0°
 Efficiency 90 %
 Peak intensity 0.3 cd/lm
 LEDs/each optic 1
 Light colour White
 Required components:

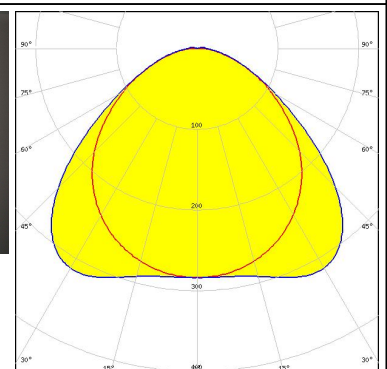
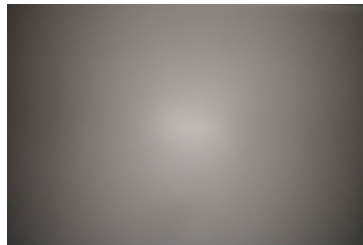

PHILIPS

LED Fortimo LED Strip 1ft 650lm FC HV4 & LV4
 FWHM / FWTM 104.0° / 158.0 + 147.0°
 Efficiency 87 %
 Peak intensity 0.3 cd/lm
 LEDs/each optic 1
 Light colour White
 Required components:

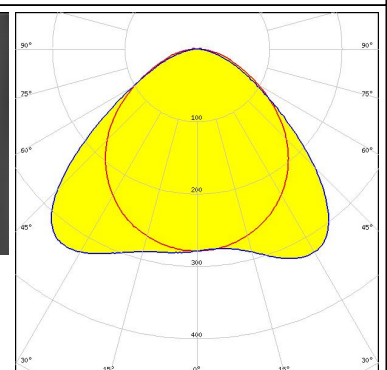

OPTICAL RESULTS (MEASURED):

PHILIPS

LED Fortimo LED Strip 1ft 650lm FC HV5 & LV5
 FWHM / FWTM 104.0 + 107.0° / 159.0 + 156.0°
 Efficiency 90 %
 Peak intensity 0.3 cd/lm
 LEDs/each optic 1
 Light colour White
 Required components:

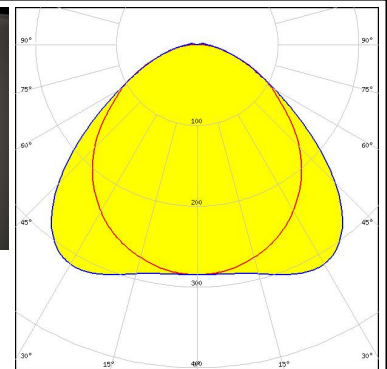

SAMSUNG

LED LM28xB Series
 FWHM / FWTM 110.0 + 103.0° / 155.0°
 Efficiency 91 %
 Peak intensity 0.3 cd/lm
 LEDs/each optic 1
 Light colour White
 Required components:

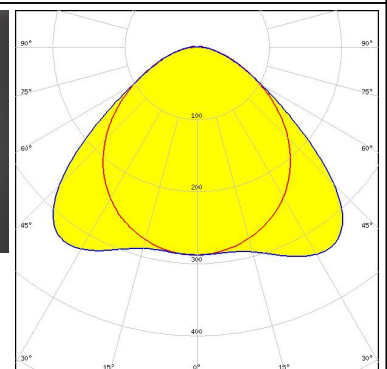

SAMSUNG

LED LM301B
 FWHM / FWTM 105.0 + 110.0° / 160.0 + 155.0°
 Efficiency 89 %
 Peak intensity 0.3 cd/lm
 LEDs/each optic 1
 Light colour White
 Required components:

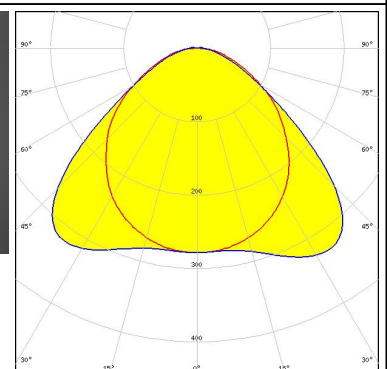
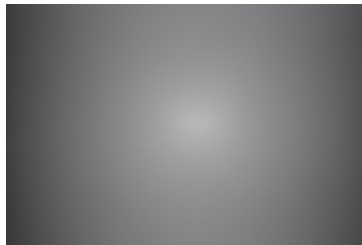

SAMSUNG

LED LM561C
 FWHM / FWTM 110.0 + 105.0° / 155.0 + 159.0°
 Efficiency 90 %
 Peak intensity 0.3 cd/lm
 LEDs/each optic 1
 Light colour White
 Required components:

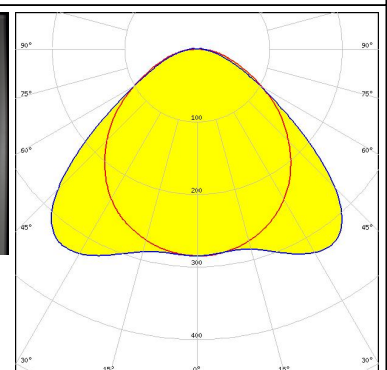
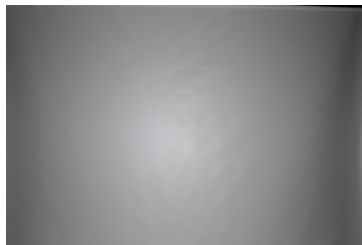

OPTICAL RESULTS (MEASURED):

SAMSUNG

LED LT-H282C
 FWHM / FWTM 107.0 + 105.0° / 151.0 + 159.0°
 Efficiency 90 %
 Peak intensity 0.3 cd/lm
 LEDs/each optic 1
 Light colour White
 Required components:

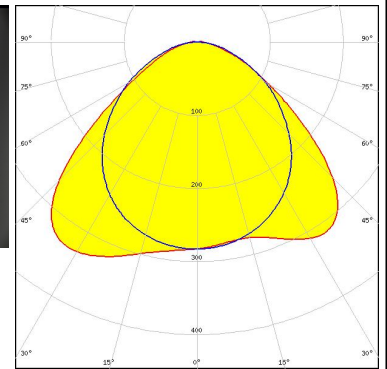

SAMSUNG

LED LT-Q282B
 FWHM / FWTM 104.0 + 106.0° / 159.0 + 151.0°
 Efficiency 90 %
 Peak intensity 0.3 cd/lm
 LEDs/each optic 1
 Light colour White
 Required components:

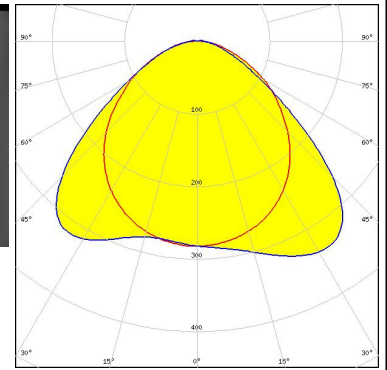
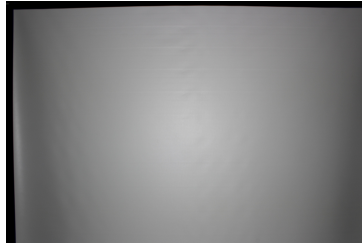

SAMSUNG

LED LT-S282H
 FWHM / FWTM 104.0 + 107.0° / 158.0 + 152.0°
 Efficiency 90 %
 Peak intensity 0.3 cd/lm
 LEDs/each optic 1
 Light colour White
 Required components:

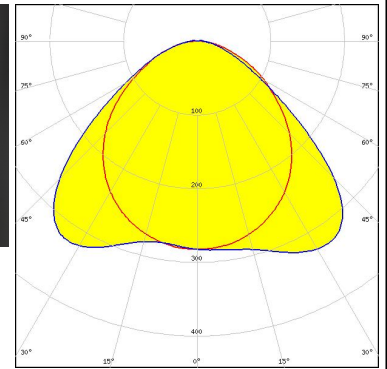
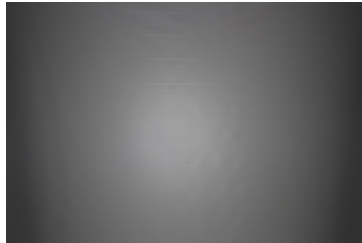

SEOUL SEMICONDUCTOR

LED SEOUL DC 3528
 FWHM / FWTM 104.0 + 110.0° / 159.0 + 155.0°
 Efficiency 91 %
 Peak intensity 0.3 cd/lm
 LEDs/each optic 1
 Light colour White
 Required components:

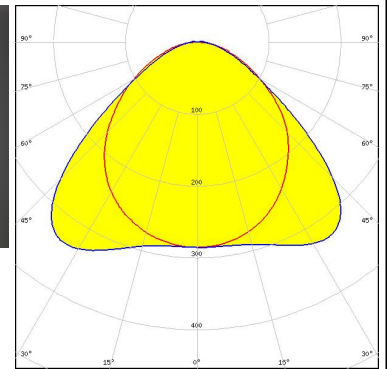

OPTICAL RESULTS (MEASURED):

TRIDONIC

LED LLE 24x280mm 1250lm HV ADV5
 FWHM / FWTM 104.0° / 159.0 + 147.0°
 Efficiency 86 %
 Peak intensity 0.3 cd/lm
 LEDs/each optic 1
 Light colour White
 Required components:

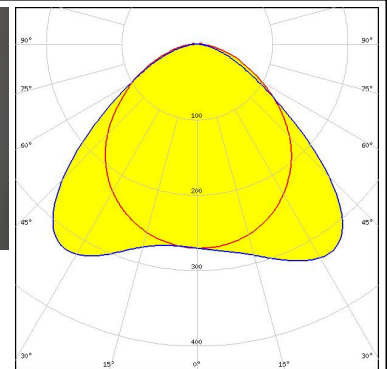

TRIDONIC

LED LLE 24x280mm 650lm HV ADV5
 FWHM / FWTM 106.0 + 104.0° / 159.0 + 147.0°
 Efficiency 86 %
 Peak intensity 0.3 cd/lm
 LEDs/each optic 1
 Light colour White
 Required components:

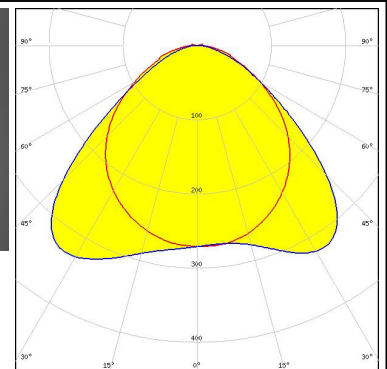
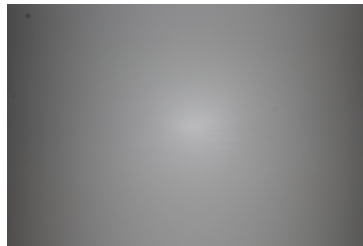

TRIDONIC

LED LLE FLEX CC 14mm 1250lm ADV1
 FWHM / FWTM 103.0 + 106.0° / 160.0 + 151.0°
 Efficiency 88 %
 Peak intensity 0.3 cd/lm
 LEDs/each optic 1
 Light colour White
 Required components:

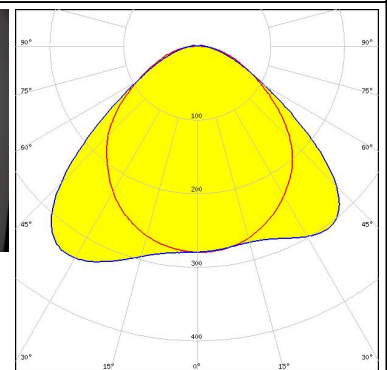
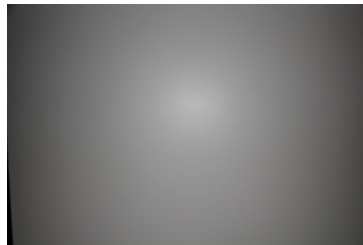

OPTICAL RESULTS (SIMULATED):

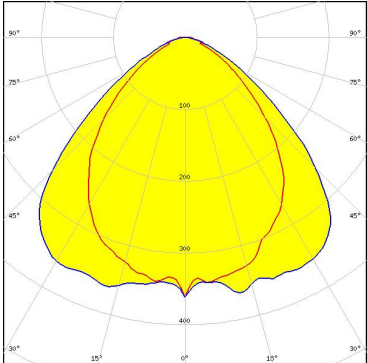
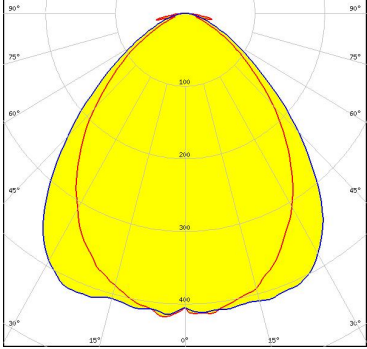
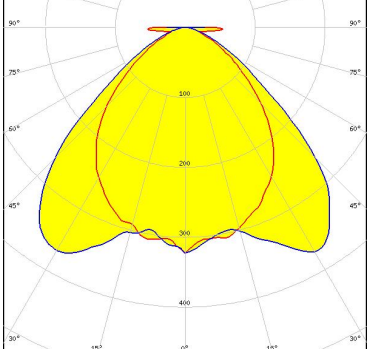
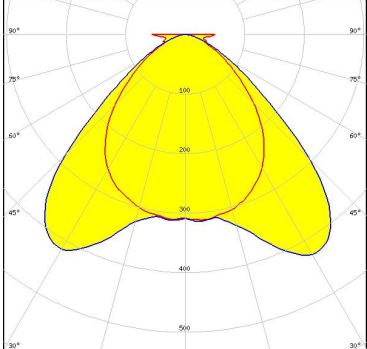
<p>bridgelux.</p> <p>LED: Bridgelux SMD 5050 FWHM / FWTM: 84.0 + 102.0° / 130.0 + 140.0° Efficiency: 83 % Peak intensity: 0.4 cd/lm LEDs/each optic: 1 Light colour: White Required components:</p>	
<p>LUMILEDS</p> <p>LED: LUXEON CSP HL1 FWHM / FWTM: 84.0 + 94.0° / 142.0 + 138.0° Efficiency: 88 % Peak intensity: 0.4 cd/lm LEDs/each optic: 5 Light colour: White Required components:</p>	
<p>NICHIA</p> <p>LED: NFSWE11A FWHM / FWTM: 89.0 + 100.0° / 180.0 + 138.0° Efficiency: 83 % Peak intensity: 0.4 cd/lm LEDs/each optic: 1 Light colour: White Required components:</p>	
<p>OSRAM <small>Opto Semiconductors</small></p> <p>LED: OSCONIQ P 3030 FWHM / FWTM: 92.0 + 97.0° / 180.0 + 135.0° Efficiency: 90 % Peak intensity: 0.2 cd/lm LEDs/each optic: 1 Light colour: Hyper Red Required components:</p>	

OPTICAL RESULTS (SIMULATED):

OSRAM
Opto Semiconductors

LED OSLOM Square CSSRM2/CSSRM3
 FWHM / FWTM 84.0 + 104.0° / 127.5 + 139.0°
 Efficiency 87 %
 Peak intensity 0.4 cd/lm
 LEDs/each optic 1
 Light colour White
 Required components:

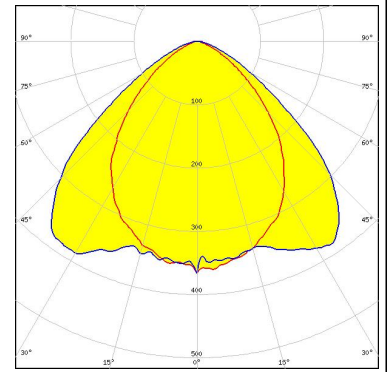

SEOUL
SEOUL SEMICONDUCTOR

LED SEOUL DC 5050 6V
 FWHM / FWTM 88.0 + 102.0° / 130.0 + 140.0°
 Efficiency 83 %
 Peak intensity 0.4 cd/lm
 LEDs/each optic 1
 Light colour White
 Required components:

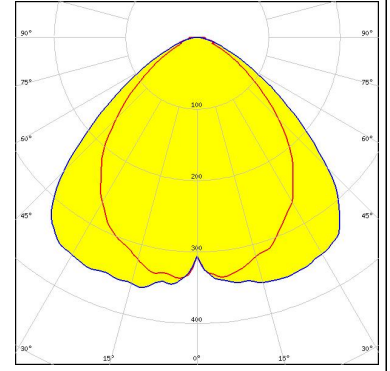

GENERAL INFORMATION:

NOTE: The typical beam angle will be changed by different color, chip size and chip position tolerance. The typical total beam angle is the full angle measured where the luminous intensity is half of the peak value.

Due to use of high power COB's with this product, special attention to proper thermal design is highly recommended. LEDiL has no liability for direct, indirect or consecutive damages arising from the LEDiL products being used outside of the recommended temperature range.

MATERIALS:

As part of our continuous research and improvement processes, and to ensure the best possible quality and availability of our products, LEDiL reserves the right to change material grades without notice.

PRODUCT DATA USER AGREEMENT AND DISCLAIMER:

The measured data in the provided downloadable LEDiL Product Datasheets and Mechanical 2D-Drawings is rounded and provided as reference for planning. LEDiL Oy's optical specifications have been verified by conducting performance testing of the products in accordance with the company's quality system. The reported data are averaged results of multiple measurements with typical variation. LEDiL Oy reserves the right to without prior notification make changes and improvements to its products.

LEDiL Oy assumes neither warranty, nor guarantee nor any other liability of any kind for the contents and correctness of the provided data. The provided data has been generated with highest diligence but the provided data may in reality not represent the complete possible variation range of all intrinsic parameters. Therefore, in certain cases a deviation from the provided data could occur.

LEDiL Oy reserves the right to undertake technical changes of its products without further notification which could lead to changes in the provided data. LEDiL Oy assumes no liability of any kind for the possible deviation from any provided data or any other damage resulting from the usage of the provided data.

The user agrees to this disclaimer and user agreement with the download or usage of the provided files.

LEDiL Oy

Joensuunkatu 13
FI-24240 SALO
Finland

LEDiL Inc.

228 West Page Street
Suite D
Sycamore IL 60178
USA

Ledil Optics Technology (Shenzhen) Co., Ltd.

405 , Block B
Casic Motor Building
Shenzhen 518057
P.R.CHINA

Local sales and technical support

[www.ledil.com/
where_to_buy](http://www.ledil.com/where_to_buy)

Shipping locations

Salo, Finland
Hong Kong, China

Distribution Partners

[www.ledil.com/
where_to_buy](http://www.ledil.com/where_to_buy)