



NTC thermistors for temperature measurement

SMD NTC thermistors for automotive applications

Series/Type:	Automotive series
Ordering code:	B57***V5
Date:	15.11.2022
Version:	1

Applications

Temperature measurement and compensation in various automotive circuits such as

- charging and temperature control of battery packs and battery management systems (BMS)
- electronic control units (ECUs), e.g. motor management, HVAC, electronic power steering (EPS), gearbox controls, ABS systems
- temperature sensor for air-conditioning
- LED lighting
- DC/DC converter, inverters, on-board charger (OBC)
- thermal protection of semiconductors (GaN / SiC) in power modules

Features

- Qualification based on AEC-Q200
- Multilayer SMD NTC thermistor with nickel barrier termination (AgNiSn)
- Accurate temperature measurement from -40 °C to 150°C
- Excellent long-term aging stability in high temperature and high humidity environment
- Tight R- and B- tolerances
- Short response time
- High mechanical robustness (selected types also available with soft termination)
- 100% Pb free, RoHS
- UL approval, file number E69802

Dimensional drawing

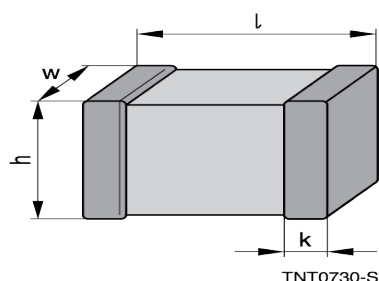

Case size EIA/mm	l	w	h	k
0402/1005	1.0 ± 0.1	0.5 ± 0.05	0.6 max.	0.25 ± 0.15
0603/1608	1.6 ± 0.15	0.8 ± 0.15	0.9 max.	0.35 ± 0.15
0805/2012	2.0 ± 0.2	1.25 ± 0.15	1.3 max.	0.5 ± 0.25

Recommended solder pad layout

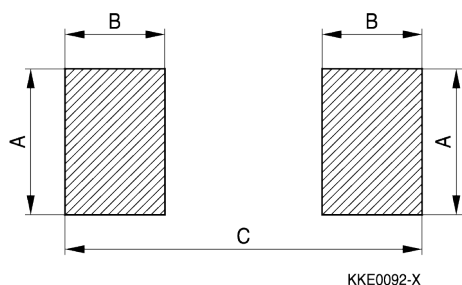

Case size EIA/mm	A mm	B mm	C mm
0402/1005	0.6	0.6	1.7
0603/1608	1.0	1.0	3.0
0805/2012	1.3	1.2	3.4

General technical data, case size 0402 (1005)

Operating temperature	T_{op}	-40 ... 150	°C
Maximum power (at 25 °C, on PCB)	$P_{25}^{1)}$	150	mW
Rated temperature	T_R	25	°C
Dissipation factor (on PCB)	$\delta_{th}^{1)}$	approx. 2.5	mW/K
Thermal cooling time constant (on PCB)	$\tau_c^{1)}$	approx. 3	s
Heat capacity	$C_{th}^{1)}$	approx. 7.5	mJ/K
Weight of component		approx. 2	mg

1) Depends on mounting situation

Electrical specifications and ordering codes, case size 0402 (1005)

R_{25} k Ω	$\Delta R_R/R_R$ %	$B_{25/50}$ K	$B_{25/85}$ K	$B_{25/100}$ K	Ordering code
4.7 k	±5	3940	3980	4000 ±3%	B57251V5472J060
10 k	±0.5, ±1, ±3, ±5	3380	3435	3455 ±1%	B57232V5103+360
10 k	±5	3940	3980	4000 ±3%	B57251V5103J060
47 k	±1, ±3, ±5	4050	4108	4131 ±1%	B57259V5473+360 *)
100 k	±1, ±3, ±5	4250	4311	4334 ±1%	B57254V5104+360

+ = Resistance tolerance D = ±0.5%, F = ±1%, H = ±3%, J = ±5%

*) extended temperature range -45°C – 150 °C

General technical data, case size 0603 (1608)

Operating temperature	T_{op}	-40 ... 150	°C
Maximum power (at 25 °C, on PCB)	$P_{25}^{(1)}$	180	mW
Rated temperature	T_R	25	°C
Dissipation factor (on PCB)	$\delta_{th}^{(1)}$	approx. 3	mW/K
Thermal cooling time constant (on PCB)	$\tau_c^{(1)}$	approx. 4	s
Heat capacity	$C_{th}^{(1)}$	approx. 12	mJ/K
Weight of component		approx. 6	mg

1) Depends on mounting situation

Electrical specifications and ordering codes, case size 0603 (1608)

R ₂₅ kΩ	$\Delta R_R/R_R$ %	B _{25/50} K	B _{25/85} K	B _{25/100} K	Ordering code
10 k	±1	3366	3419	3439 ±0.5%	B57333V5103F460
10 k	±0.5	3380	3435	3455 ±0.7%	B57332V5103D560
10 k	±1, ±3, ±5	3380	3435	3455 ±1%	B57332V5103+360 **)
10 k	±1, ±3, ±5	3568	3610	3624 ±1%	B57343V5103+360
10 k	±3, ±5	3590	3635	3650 ±3%	B57342V5103+060 **)
10 k	±1, ±3, ±5	3940	3980	4000 ±1%	B57358V5103+360
10 k	±3, ±5	3940	3980	4000 ±3%	B57351V5103+060
10 k	±3, ±5	4386	4455	4480 ±3%	B57352V5103+060
22 k	±3, ±5	3940	3980	4000 ±3%	B57351V5223+060
22 k	±3, ±5	4386	4455	4480 ±3%	B57352V5223+060
47 k	±1, ±3, ±5	4050	4108	4131 ±1.5%	B57359V5473+260 *) **)
47 k	±3, ±5	4050	4108	4131 ±2%	B57359V5473+160 *)
47 k	±3, ±5	4386	4455	4480 ±3%	B57352V5473+060
100 k	±1, ±3, ±5	4200	4260	4282 ±1%	B57355V5104+360
100 k	±3, ±5	4250	4311	4334 ±2%	B57354V5104+160
100 k	±1, ±3, ±5	4386	4455	4131 ±1.5%	B57359V5104+260
100 k	±1, ±3, ±5	4386	4455	4480 ±1%	B57352V5104+360
100 k	±3, ±5	4386	4455	4480 ±3%	B57352V5104+060

+ = Resistance tolerance F = ±1%, G = ±2%, H = ±3%, J = ±5%

*) extended temperature range -45°C – 150 °C

**) also available in soft termination. For further information, please contact your local sales organization.

General technical data, case size 0805 (2012)

Operating temperature	T_{op}	-40 ... 150	°C
Maximum power (at 25 °C, on PCB)	$P_{25}^{(1)}$	210	mW
Rated temperature	T_R	25	°C
Dissipation factor (on PCB)	$\delta_{th}^{(1)}$	approx. 3.5	mW/K
Thermal cooling time constant (on PCB)	$\tau_c^{(1)}$	approx. 10	s
Heat capacity	$C_{th}^{(1)}$	approx. 35	mJ/K
Weight of component		approx. 13	mg

1) Depends on mounting situation

Electrical specifications and ordering codes, case size 0805 (2012)

R_{25} k Ω	$\Delta R_R/R_R$ %	$B_{25/50}$ K	$B_{25/85}$ K	$B_{25/100}$ K	Ordering code
4.7 k	$\pm 3, \pm 5$	3590	3635	3650 $\pm 3\%$	B57442V5472+062
4.7 k	$\pm 3, \pm 5$	4386	4455	4480 $\pm 3\%$	B57452V5472+062
10 k	$\pm 3, \pm 5$	3590	3635	3650 $\pm 3\%$	B57442V5103+062
10 k	$\pm 3, \pm 5$	3940	3980	4000 $\pm 3\%$	B57451V5103+062
10 k	$\pm 3, \pm 5$	4386	4455	4480 $\pm 3\%$	B57452V5103+062
33 k	$\pm 3, \pm 5$	3940	3980	4000 $\pm 3\%$	B57451V5333+062
47 k	$\pm 3, \pm 5$	3940	3980	4000 $\pm 3\%$	B57451V5473+062
47 k	$\pm 1, \pm 3, \pm 5$	4050	4108	4131 $\pm 1.5\%$	B57459V5473+262
100 k	$\pm 3, \pm 5$	4386	4455	4480 $\pm 3\%$	B57452V5104+062

+ = Resistance tolerance F = $\pm 1\%$, G = $\pm 2\%$, H = $\pm 3\%$, J = $\pm 5\%$

Reliability data

Tests of SMD NTC thermistors are based on AEC-Q200.

The parts are mounted on standardized PCB.

Test	Standard	Test conditions	$\Delta R_{25} / R_{25}$ (typical)	Remarks
Pre- and post-stress electrical test		Resistance at: 25 °C and 100 °C	-	
High temperature exposure (storage)	MIL-STD-202, method 108	Test temperature: 150 °C Duration: 1000 h Unpowered Except B57*32V5* and B57*59V5* B57*54V5* and B57*55V5*	< 5% <1% <2%	
Temperature cycling	JESD22, method JA-104	Lower test temperature: Top min Upper test temperature: Top max Number of cycles: 1000 Transfer time: < 10 s Dwell time: 15 min Air – Air	< 5%	Temperature cycling is performed acc. MIL-STD-202, method 107. No warrant will be assumed for the reliability of solder joint.
Biased humidity	MIL-STD-202, method 103	Test temperature: 85 °C Rel. humidity of air: 85% Duration: 1000 h Test voltage: $V_{NTC} = 0.3 \text{ V DC}$	< 5%	
Operational life	MIL-STD-202, method 108	Test temperature: 150 °C $P_{max} = 0.35 \text{ mW}$ Duration: 1000 h	< 5%	
External visual	MIL-STD-883E, method 2009	Visual inspection		
Physical dimensions	JESD22, method JB-100	Measured with callipers		Within the specified values
Resistance to solvents	MIL-STD-202, method 215	Not applicable for SMD NTC thermistors (component has no marking, color coding or coating)		
Mechanical shock	MIL-STD-202, method 213	Peak value: 1500 g Half sine Condition F	< 5%	

Test	Standard	Test conditions	$\Delta R_{25} / R_{25}$ (typical)	Remarks
Vibration	MIL-STD-202, method 204	Acceleration: 5 g Sweep time: 20 min Frequency range: 10 ... 2000 Hz 3 x 12 cycles Except B574*V5*	< 1% < 5%	
Resistance to soldering heat	MIL-STD-202, method 210	Dip: 260 °C; 10 s 1 heat cycle Except B57*32V5* and B57*59V5* B57*54V5* and B57*55V5*	< 3% < 1% < 1%	
ESD	AEC-Q200-002, method -002	Discharge capacitance: 150 pF Discharge resistance: 2 kΩ Charging voltage: 6 kV Contact discharge 2 pulses in each polarity	< 5%	
Solderability	J-STD-002	a) Dip: 235 °C; 5 s: aging 4 h @ 155 °C b) Dip: 215 °C; 5 s: steam aging 8 h @ 92 °C c) Dip: 260 °C; 7 s: steam aging 8 h @ 92 °C		95% of termination wetted
Electrical characterization		R(25 °C), R(100 °C), B(25/100)		Within the specified values
Flammability	UL-94;V-0 or V-1	Not applicable for SMD NTC thermistors (component is not coated or encapsulated with plastic materials)		
Board flex	AEC-Q200-005, method -005	B572*V5* Max. bending 1mm B573*V5* Max. bending 2mm B574*V5* Max. bending 2mm Duration @ max. bending: 60 s	< 2% < 2% < 5%	
Terminal strength	AEC-Q200-006, method -006	B572*V5* Max. F: 5 N B573*V5* Max. F: 10 N B574*V5* Max. F: 17 N	< 2% < 2% < 5%	
Resistance drift after soldering		Reflow soldering profile	< 1%	

Recommended soldering profiles

Reflow soldering

Temperature ranges for reflow soldering acc. To IEC 60068-2-58 recommendations.

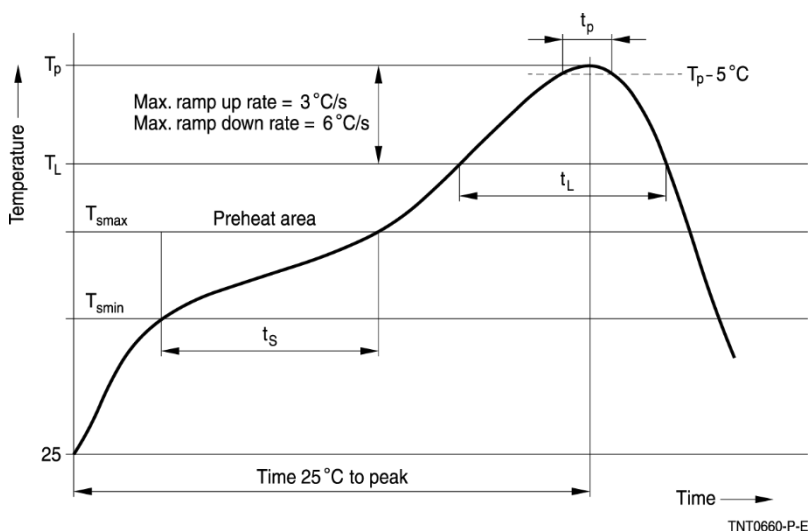

Profile feature		Sn-Pb eutectic assembly	Pb-free assembly
Preheat and soak			
- Temperature min	T_{smin}	100 °C	150 °C
- Temperature max	T_{smax}	150 °C	200 °C
- Time	t_s	60 ... 120 s	60 ... 120 s
Average ramp-up rate	T_{smax} to T_p	3 °C/ s max.	3 °C/ s max.
Liquidous temperature	T_L	183 °C	217 °C
Time at liquidous	t_L	40 ... 150 s	40 ... 150 s
Peak package body temperature	$T_p^{1)}$	215 °C ... 260 °C	235 °C ... 260 °C
Time (t_p) above ($T_p - 5$ °C)	t_p	10 ... 40 s	10 ... 40 s
Average ramp-down rate	T_p to T_{smax}	6 °C/ s max.	6 °C/ s max.
Time 25 °C to peak temperature		max. 8 minutes	max. 8 minutes

1) Depending on package thickness.

Note: All temperatures refer to topside of the package, measured on the package body surface.

Number of reflow cycles: 3

Iron soldering should be avoided hot air methods are recommended for repair purposes.

Recommended solder

Flux less Pb-free Sn (95.1 ... 96.0), Ag (3.0 ... 4.0), Cu (0.5 ... 0.9) solder is recommended.

Taping and packing

Tape and reel packing according to IEC 60286-3

Reel dimensions and tolerances

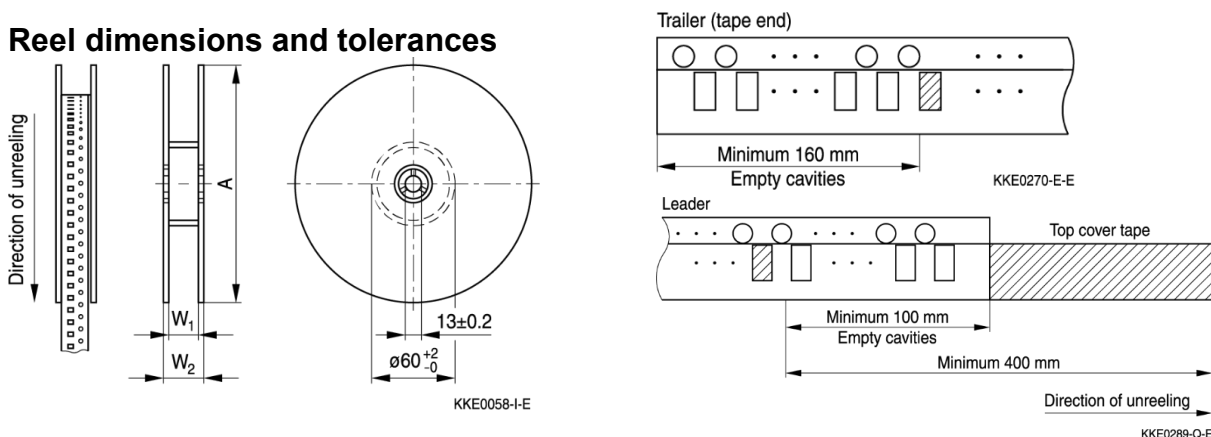

		8-mm tape	
Definition	Symbol	180-mm reel	330-mm reel
Reel diameter	A	180 +0/-3	330 +0/-2.0
Reel width (inside)	W1	8.4 +1.5/-0	8.4 +1.5/-0
Reel width (outside)	W2	14.4 max.	14.4 max.

Packing units for discrete chip

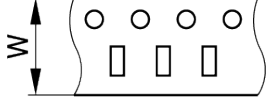
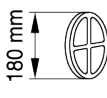
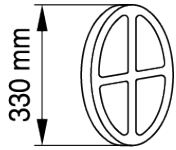
Case size inch/mm	Chip thickness class				
		Cardboard tape W	Blister tape W	∅ 180-mm reel pcs.	∅ 330-mm reel pcs.
0402/1005	0.5 mm	8 mm	–	10000	50000
0603/1608	0.8 mm	8 mm	–	4000	16000
0805/2012	0.8 mm	–	8 mm	4000*)	16000
	1.2 mm	–	8 mm	3000	12000

) Except B57442V5103 3000 pcs. / reel

Packing codes

The last two digits of the complete ordering code state the packing mode.

60 ≙ cardboard tape, 180-mm reel

62 ≙ blister tape, 180-mm reel

70 ≙ cardboard tape, 330-mm reel

72 ≙ blister tape, 330-mm reel

Cautions and warnings

Storage

- Store thermistors only in original packaging. Do not open the package before storage.
- Storage conditions in original packaging: storage temperature $-25\text{ °C} \dots +45\text{ °C}$, relative humidity $\leq 75\%$ annual mean, 95% on max. 30 days in a year, dew precipitation and wetness are inadmissible.
- Do not store SMDs where they are exposed to heat or direct sunlight. Otherwise, the packing material may be deformed or SMDs may stick together, causing problems during mounting.
- Avoid contamination of thermistors surface during storage, handling and processing. Touching the metallization of unsoldered thermistors may change their soldering properties.
- Avoid storage of thermistor in harmful environments like corrosive gases (SO_x , Cl etc.)
- After opening the factory seals, such as polyvinyl-sealed packages, use the SMDs as soon as possible.
- Solder thermistors after shipment from TDK Electronics within the time specified:
SMD NTC thermistors with nickel-barrier termination: 12 months

Handling

- NTC thermistors must not be dropped. Chip-offs must not be caused during handling of NTCs.
- Components must not be touched with bare hands. Gloves are recommended.
- Avoid contamination of thermistor surface during handling.
- Washing processes may damage the product due to the possible static or cyclic mechanical loads (e.g. ultrasonic cleaning). They may cause cracks to develop on the product and its parts, which might lead to reduced reliability or lifetime.

Soldering

- Use resin-type flux or non-activated flux.
- Insufficient preheating may cause ceramic cracks.
- Rapid cooling by dipping in solvent is not recommended.
- Complete removal of flux is recommended.

Mounting

- When NTC thermistors are encapsulated with sealing material or over molded with plastic material, there must be no mechanical stress caused by thermal expansion during the production process (curing / over molding process) and during later operation. The upper category temperature of the thermistor must not be exceeded. Ensure that the materials used (sealing compound and plastic material) are chemically neutral.
- Electrode must not be scratched before/during/after the mounting process.
- Contacts and housing used for assembly with thermistor have to be clean before mounting.
- Ensure that adjacent materials are designed for operation at temperatures comparable to the surface temperature of the thermistor. Be sure that surrounding parts and materials can withstand the temperature.
- Avoid contamination of thermistor surface during processing.

Operation

- Use thermistors only within the specified operating temperature range.
- Environmental conditions must not harm the thermistors. Use thermistors only in normal atmospheric conditions.

- Contact of NTC thermistors with any liquids and solvents should be prevented. It must be ensured that no water enters the NTC thermistors (e.g. through plug terminals). For measurement purposes (checking the specified resistance vs. temperature), the component must not be immersed in water but in suitable liquids (e.g. Galden).
- Avoid dewing and condensation.
- Be sure to provide an appropriate fail-safe function to prevent secondary product damage caused by malfunction (e.g. use VDR for limitation of overvoltage condition).

This listing does not claim to be complete, but merely reflects the experience of TDK Electronics AG.

Display of ordering codes for TDK Electronics products

The ordering code for one and the same product can be represented differently in data sheets, data books, other publications, on the company website, or in order-related documents such as shipping notes, order confirmations and product labels. **The varying representations of the ordering codes are due to different processes employed and do not affect the specifications of the respective products.** Detailed information can be found on the Internet under www.tdk-electronics.tdk.com/orderingcodes.

Important notes

The following applies to all products named in this publication:

1. Some parts of this publication contain **statements about the suitability of our products for certain areas of application**. These statements are based on our knowledge of typical requirements that are often placed on our products in the areas of application concerned. We nevertheless expressly point out **that such statements cannot be regarded as binding statements about the suitability of our products for a particular customer application**. As a rule we are either unfamiliar with individual customer applications or less familiar with them than the customers themselves. For these reasons, it is always ultimately incumbent on the customer to check and decide whether a product with the properties described in the product specification is suitable for use in a particular customer application.
2. We also point out that **in individual cases, a malfunction of electronic components or failure before the end of their usual service life cannot be completely ruled out in the current state of the art, even if they are operated as specified**. In customer applications requiring a very high level of operational safety and especially in customer applications in which the malfunction or failure of an electronic component could endanger human life or health (e.g. in accident prevention or life-saving systems), it must therefore be ensured by means of suitable design of the customer application or other action taken by the customer (e.g. installation of protective circuitry or redundancy) that no injury or damage is sustained by third parties in the event of malfunction or failure of an electronic component.
3. **The warnings, cautions and product-specific notes must be observed.**
4. In order to satisfy certain technical requirements, **some of the products described in this publication may contain substances subject to restrictions in certain jurisdictions (e.g. because they are classed as hazardous)**. Useful information on this will be found in our Material Data Sheets on the Internet (www.tdk-electronics.tdk.com/material). Should you have any more detailed questions, please contact our sales offices.
5. We constantly strive to improve our products. Consequently, **the products described in this publication may change from time to time**. The same is true of the corresponding product specifications. Please check therefore to what extent product descriptions and specifications contained in this publication are still applicable before or when you place an order.

We also **reserve the right to discontinue production and delivery of products**. Consequently, we cannot guarantee that all products named in this publication will always be available. The aforementioned does not apply in the case of individual agreements deviating from the foregoing for customer-specific products.

6. Unless otherwise agreed in individual contracts, **all orders are subject to our General Terms and Conditions of Supply**.
7. **Our manufacturing sites serving the automotive business apply the IATF 16949 standard**. The IATF certifications confirm our compliance with requirements regarding the quality management system in the automotive industry. Referring to customer requirements and customer specific requirements ("CSR") TDK always has and will continue to have the policy of respecting individual agreements. Even if IATF 16949 may appear to support the acceptance of unilateral requirements, we hereby like to emphasize that **only requirements mutually agreed upon can and will be implemented in our Quality Management System**. For clarification purposes we like to point out that obligations from IATF 16949 shall only become legally binding if individually agreed upon.

Important notes

8. The trade names EPCOS, CarXield, CeraCharge, CeraDiode, CeraLink, CeraPad, CeraPlas, CSMP, CTVS, DeltaCap, DigiSiMic, ExoCore, FilterCap, FormFit, InsuGate, LeaXield, MiniBlue, MiniCell, MKD, MKK, ModCap, MotorCap, PCC, PhaseCap, PhaseCube, PhaseMod, PhiCap, PowerHap, PQSine, PQvar, SIFERRIT, SIFI, SIKOREL, SilverCap, SIMDAD, SiMic, SIMID, SineFormer, SIOV, ThermoFuse, WindCap, XieldCap are **trademarks registered or pending** in Europe and in other countries. Further information will be found on the Internet at www.tdk-electronics.tdk.com/trademarks.

Release 2022-07