

CGA3E2C0G1H181J080AD

TDK Item Description : CGA3E2C0G1H181JT***B



Equivalent C1608C0G1H181J for Automotive

Application & Main Feature

Automotive Grade (Conductive Epoxy Application)

Series

CGA3(1608) [EIA CC0603]

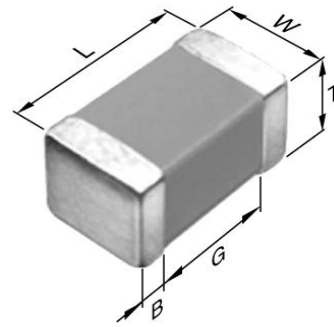

Dimensions

L 1.60mm +/-0.15mm
 W 0.80mm +/-0.15mm
 T 0.80mm +/-0.15mm
 B 0.20mm Min.
 G 0.30mm Min.

Temperature Characteristic

C0G (-55 to 125 degC 0+/-30ppm/degC)

Rated Voltage

1H (50Vdc)

Capacitance

180pF

Capacitance Tolerance

J (+/-5%)

Q Factor

1000 Min.

Insulation Resistance

10Gohm Min.

AEC-Q200

Yes

|Z|, ESR vs. Freq. Characteristics

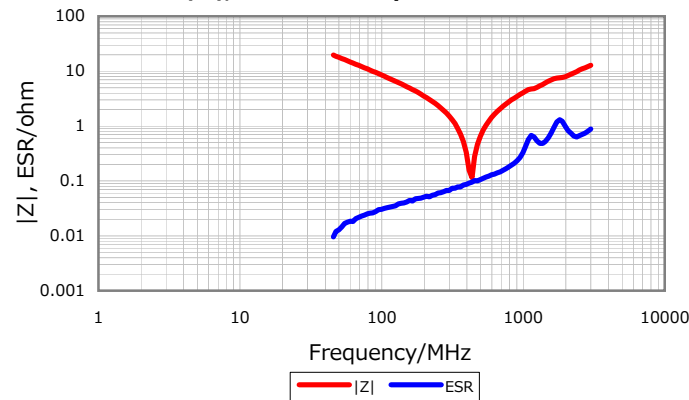

DC Bias Characteristic

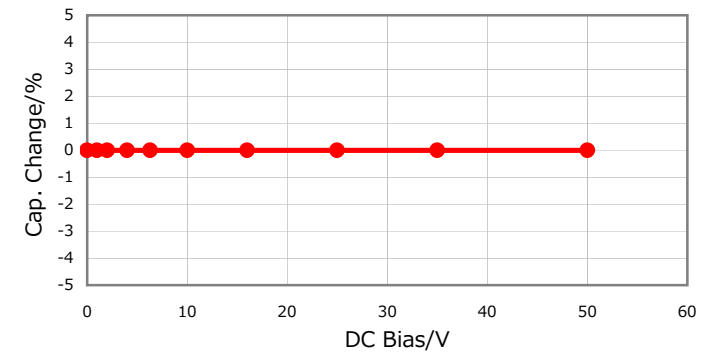

Cap. vs. Freq. Characteristic

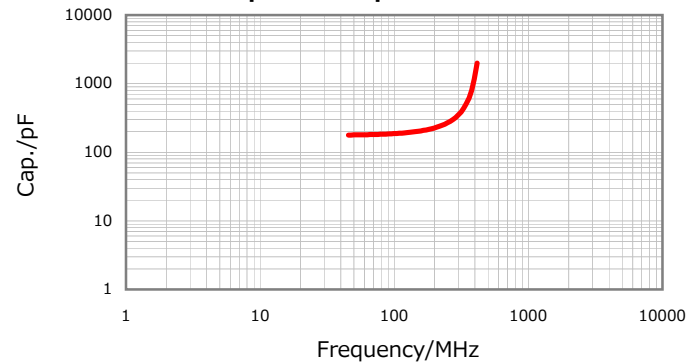

Temperature Characteristics

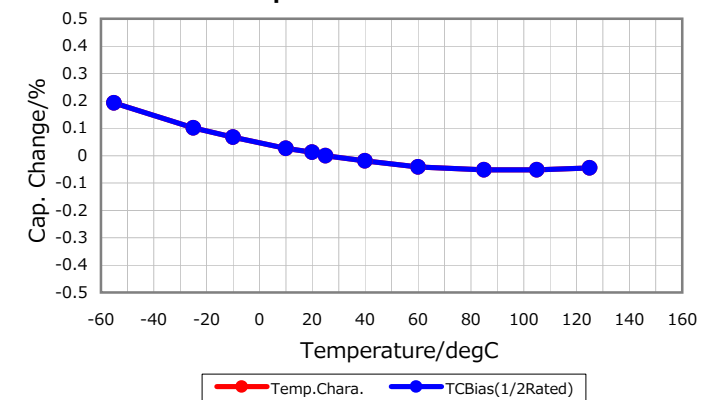

Characterization Sheet (Multilayer Ceramic Chip Capacitors)



All specifications are subject to change without notice.

January 4, 2016