

Data sheet | Item number: 2001-1302

3-conductor through terminal block; 1.5 mm²; suitable for Ex e II applications; side and center marking; for DIN-rail 35 x 15 and 35 x 7.5; Push-in CAGE CLAMP®; 1,50 mm²; orange

www.wago.com/2001-1302

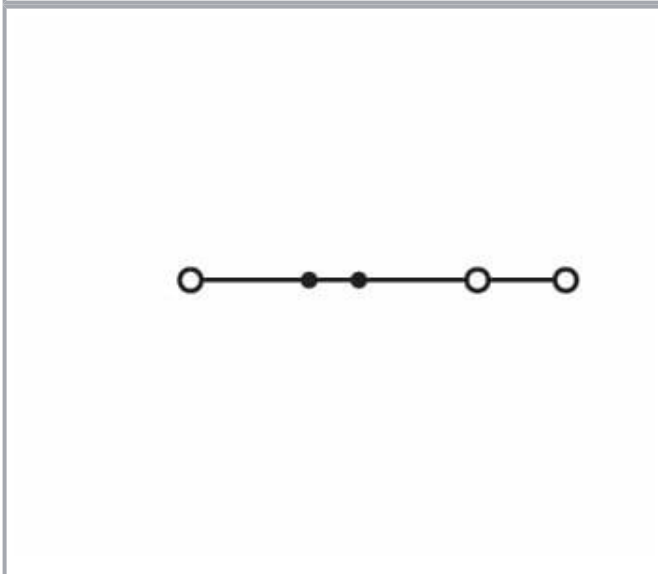
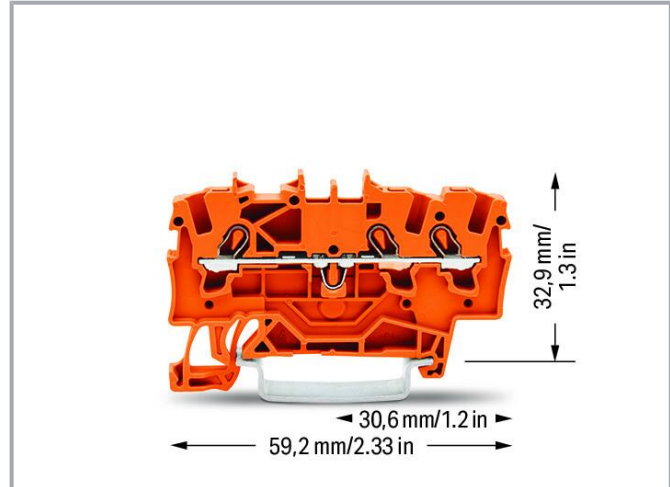
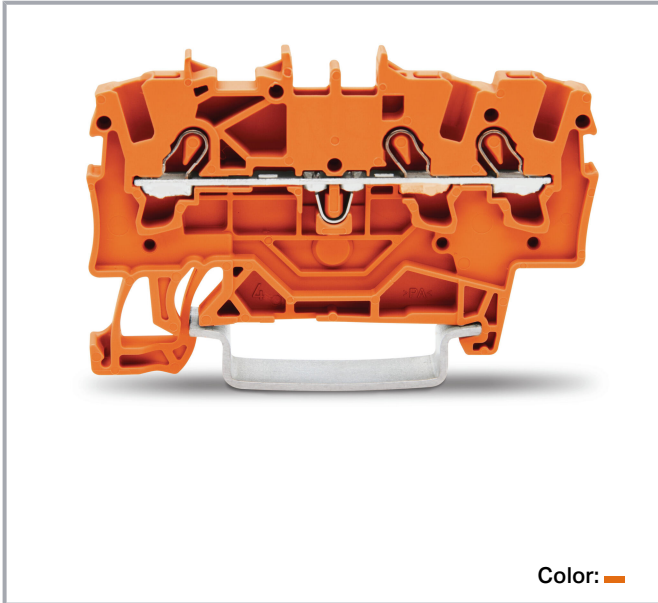

Data

Electrical data

Subject to changes. Please also observe the further product documentation!

WAGO GmbH & Co. KG
Hansastr. 27
32423 Minden
Phone: +49571 887-0 | Fax: +49571 887-169
Email: info.de@wago.com | Web: www.wago.com

Do you have any questions about our products?
We are always happy to take your call at +49 (571) 887-44222.

Ratings per IEC/EN

Ratings per	IEC/EN 60947-7-1
Nominal voltage (III/3)	800 V
Rated impulse voltage (III/3)	8 kV
Rated current	18 A
Current at conductor cross-section (max.) mm ²	24 A
Legend (ratings)	(III / 3) ≙ Overvoltage category III / Pollution degree 3

Ratings per UL 1059

Approvals per	UL 1059
Rated voltage UL (Use Group B)	600 V
Rated current UL (Use Group B)	15 A
Rated voltage UL (Use Group C)	600 V
Rated current UL (Use Group C)	15 A

Ratings per CSA

Approvals per	CSA 22.2 No 158
Rated voltage CSA (Use Group B)	600 V
Rated current CSA (Use Group B)	15 A
Rated voltage CSA (Use Group C)	600 V
Rated current CSA (Use Group C)	15 A

Ex information

Reference hazardous areas	See application instructions in section "Knowledge and Downloads – Documentation – Additional Information: Technical Section; Technical Explications"
Ratings per	ATEX: PTB 05 ATEX 1094 U / IECEx: PTB 05.0034U (Ex eb IIC Gb)
Rated voltage EN (Ex e II)	550 V
Rated current (Ex e II)	17 A
Rated current (Ex e II) with jumper	16 A

Power loss

Power loss, per pole (potential)	0.593 W
Rated current I_N for specified power loss	18 A
Resistance value for specified, current-dependent power loss	0.002 Ω

Subject to changes. Please also observe the further product documentation!



Connection data

Connection points	3
Total number of potentials	1
Number of levels	1
Number of jumper slots	2

Connection 1

Connection technology	Push-in CAGE CLAMP®
Actuation type	Operating tool
Connectable conductor materials	Copper
Nominal cross-section	1.5 mm ²
Solid conductor	0.25 ... 2.5 mm ² / 22 ... 14 AWG
Solid conductor; push-in termination	0.75 ... 2.5 mm ² / 18 ... 14 AWG
Fine-stranded conductor	0.25 ... 2.5 mm ² / 22 ... 14 AWG
Fine-stranded conductor; with insulated ferrule	0.25 ... 1.5 mm ² / 22 ... 16 AWG
Fine-stranded conductor; with ferrule; push-in termination	0.75 ... 1.5 mm ² / 18 ... 16 AWG
Note (conductor cross-section)	Depending on the conductor characteristic, a conductor with a smaller cross-section can also be inserted via push-in termination.
Strip length	9 ... 11 mm / 0.35 ... 0.43 inches
Wiring direction	Front-entry wiring

Physical data

Width	4.2 mm / 0.165 inches
Height	59.2 mm / 2.33 inches
Depth from upper-edge of DIN-rail	32.9 mm / 1.295 inches

Mechanical Data

Mounting type	DIN-35 rail
Marking level	Center/side marking

Material Data

Note (material data)	Information on material specifications can be found here
Color	orange
Material group	I

Subject to changes. Please also observe the further product documentation!

Insulation material	Polyamide (PA66)
Flammability class per UL94	V0
Fire load	0.106 MJ
Weight	4.9 g

Environmental requirements

Processing temperature	-35 ... +85 °C
Continuous operating temperature	-60 ... +105 °C

Commercial data



Product Group	22 (TOPJOB S)
eCl@ss 10.0	27-14-11-20
eCl@ss 9.0	27-14-11-20
ETIM 8.0	EC000897
ETIM 7.0	EC000897
PU (SPU)	100 pcs
Packaging type	box
Country of origin	DE
GTIN	4017332998642
Customs tariff number	85369010000

Environmental Product Compliance



RoHS Compliance Status	Compliant, No Exemption
------------------------	-------------------------

Approvals / Certificates

General approvals

Logo	Approval	Additional Approval Text	Certificate name
	CCA DEKRA Certification B.V.	EN 60947	NTR NL-7963
	CCC CNEX	GB/T 3836.3	2020312313000159 (Ex eb IIC Gb, Ex eb I Mb)
	CSA DEKRA Certification B.V.	C22.2 No. 158	1645434



Subject to changes. Please also observe the further product documentation!

	KEMA/KEUR DEKRA Certification B.V.	EN 60947	71-125954
	UL UL International Germany GmbH	UL 1059	E45172

Declarations of conformity and manufacturer's declarations

Logo	Approval	Additional Approval Text	Certificate name
	EU-Declaration of Conformity WAGO GmbH & Co. KG	-	-
	Railway WAGO GmbH & Co. KG	-	Railway Ready
	UK-Declaration of Conformity WAGO GmbH & Co. KG	-	-

Approvals for marine applications

Logo	Approval	Additional Approval Text	Certificate name
	ABS American Bureau of Shipping	EN 60947	20-HG1941090-PDA
	BV Bureau Veritas S.A.	EN 60947	38586/B0 BV
	DNV GL Det Norske Veritas, Germanischer Lloyd	-	TAE00001V2

Approvals for hazardous areas

Logo	Approval	Additional Approval Text	Certificate name
------	----------	--------------------------	------------------

Subject to changes. Please also observe the further product documentation!

WAGO GmbH & Co. KG
 Hansastr. 27
 32423 Minden
 Phone: +49571 887-0 | Fax: +49571 887-169
 Email: info.de@wago.com | Web: www.wago.com

Do you have any questions about our products?
 We are always happy to take your call at +49 (571) 887-44222.

	AEx UL International Germany GmbH c/o Physikalisch Technische Bundesanstalt	UL 60079	E185892 (AEx e II resp. Ex e II)
	ATEX Physikalisch Technische Bundesanstalt (PTB)	EN 60079	PTB 05 ATEX 1094 U (II 2 G Ex eb IIC Gb bzw. I M 2 Ex eb I Mb)
	CCC CNEX	GB/T 3836.3	2020312313000159 (Ex eb IIC Gb, Ex eb I Mb)
	EAC  Brjansker Zertifizierungsstelle	TP TC 012/2011	RU C-DE.AM02.B. 00127/19 (Ex e IIC Gb U)
	IECEX Physikalisch Technische Bundesanstalt (PTB)	IEC 60079	IECEX PTB 05. 0034 U (Ex eb IIC Gb or Ex eb I Mb)
	INMETRO TÜV Rheinland do Brasil Ltda.	IEC 60079	TÜV 12.1308 U

Required accessories

End plate

End plate

	Item no.: 2002-1391 End and intermediate plate; 0.8 mm thick; gray	www.wago.com/2002-1391
	Item no.: 2002-1392 End and intermediate plate; 0.8 mm thick; orange	www.wago.com/2002-1392













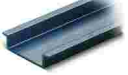

Optional accessories

Carrier rail















Mounting accessories

	Item no.: 210-197 Steel carrier rail; 35 x 15 mm; 1.5 mm thick; 2 m long; slotted; similar to EN 60715; silver-colored	www.wago.com/210-197
	Item no.: 210-198	

Subject to changes. Please also observe the further product documentation!

	Copper carrier rail; 35 x 15 mm; 2.3 mm thick; 2 m long; unslotted; according to EN 60715; copper-colored	www.wago.com/210-198
	Item no.: 210-113 Steel carrier rail; 35 x 7.5 mm; 1 mm thick; 2 m long; unslotted; according to EN 60715; silver-colored	www.wago.com/210-113
	Item no.: 210-118 Steel carrier rail; 35 x 15 mm; 2.3 mm thick; 2 m long; unslotted; according to EN 60715; silver-colored	www.wago.com/210-118
	Item no.: 210-112 Steel carrier rail; 35 x 7.5 mm; 1 mm thick; 2 m long; slotted; according to EN 60715; "Hole width 25 mm; silver-colored	www.wago.com/210-112
	Item no.: 210-114 Steel carrier rail; 35 x 15 mm; 1.5 mm thick; 2 m long; unslotted; similar to EN 60715; silver-colored	www.wago.com/210-114
	Item no.: 210-115 Steel carrier rail; 35 x 7.5 mm; 1 mm thick; 2 m long; slotted; according to EN 60715; "Hole width 18 mm; silver-colored	www.wago.com/210-115
	Item no.: 210-196 Aluminum carrier rail; 35 x 8.2 mm; 1.6 mm thick; 2 m long; unslotted; similar to EN 60715; silver-colored	www.wago.com/210-196
Jumpers		
Jumper		
	Item no.: 210-123 Wire commoning chain; insulated; blue	www.wago.com/210-123
	Item no.: 2006-499 Step-down jumper; from 2006/2004 to 2004/2002/2001 series; from 2206/2204 to 2204/2202/2201 series; insulated; light gray	www.wago.com/2006-499
	Item no.: 2001-402 Jumper; 2-way; insulated; light gray	www.wago.com/2001-402
	Item no.: 2001-403 Jumper; 3-way; insulated; light gray	www.wago.com/2001-403
	Item no.: 2001-405 Jumper; 5-way; insulated; light gray	www.wago.com/2001-405
	Item no.: 2001-406/020-000 Delta jumper; insulated; light gray	www.wago.com/2001-406/020-000
	Item no.: 2001-405/011-000 Star point jumper; 3-way; insulated; light gray	www.wago.com/2001-405/011-000
	Item no.: 2001-407 Jumper; 7-way; insulated; light gray	www.wago.com/2001-407

Subject to changes. Please also observe the further product documentation!

	Item no.: 2001-409 Jumper; 9-way; insulated; light gray	www.wago.com/2001-409
	Item no.: 2001-406 Jumper; 6-way; insulated; light gray	www.wago.com/2001-406
	Item no.: 2001-404 Jumper; 4-way; insulated; light gray	www.wago.com/2001-404
	Item no.: 2001-410 Jumper; 10-way; insulated; light gray	www.wago.com/2001-410
	Item no.: 2001-433 Jumper; from 1 to 3; insulated; light gray	www.wago.com/2001-433
	Item no.: 2001-435 Jumper; from 1 to 5; insulated; light gray	www.wago.com/2001-435
	Item no.: 2001-408 Jumper; 8-way; insulated; light gray	www.wago.com/2001-408
	Item no.: 2001-437 Jumper; from 1 to 7; insulated; light gray	www.wago.com/2001-437
	Item no.: 2001-436 Jumper; from 1 to 6; insulated; light gray	www.wago.com/2001-436
	Item no.: 2001-440 Jumper; from 1 to 10; insulated; light gray	www.wago.com/2001-440
	Item no.: 2001-438 Jumper; from 1 to 8; insulated; light gray	www.wago.com/2001-438
	Item no.: 2001-434 Jumper; from 1 to 4; insulated; light gray	www.wago.com/2001-434
	Item no.: 2001-439 Jumper; from 1 to 9; insulated; light gray	www.wago.com/2001-439
	Item no.: 210-103 Wire commoning chain; insulated; black	www.wago.com/210-103

Mounting

Cover carrier



Item no.: 709-169
Cover carrier; Type 3; gray

www.wago.com/709-169

Cover





Item no.: 709-156
Cover; Type 3; suitable for cover carrier, type 3; 1 m long; transparent

www.wago.com/709-156

Tool





Subject to changes. Please also observe the further product documentation!

Operating tool

	Item no.: 210-648 Operating tool; Blade: 2.5 x 0.4 mm; with a partially insulated shaft; angled; short	www.wago.com/210-648
	Item no.: 210-647 Operating tool; Blade: 2.5 x 0.4 mm; with a partially insulated shaft; multicoloured	www.wago.com/210-647
	Item no.: 210-719 Operating tool; Blade: 2.5 x 0.4 mm; with a partially insulated shaft	www.wago.com/210-719







Push-in type wire jumper

Jumper













	Item no.: 2009-412 Push-in type wire jumper; insulated; 60 mm long; black	www.wago.com/2009-412
	Item no.: 2009-414 Push-in type wire jumper; 1.5 mm ² ; insulated; 110 mm long; black	www.wago.com/2009-414
	Item no.: 2009-416 Push-in type wire jumper; 1.5 mm ² ; insulated; 250 mm long; black	www.wago.com/2009-416
	Item no.: 2009-414/000-005 Push-in type wire jumper; 1.5 mm ² ; insulated; 110 mm long; black	www.wago.com/2009-414/000-005
	Item no.: 2009-414/000-006 Push-in type wire jumper; insulated; 110 mm long; black	www.wago.com/2009-414/000-006

Testing and measuring













Testing accessories

	Item no.: 2009-174 Test plug adapter; for 4 mm Ø test plugs; for testing TOPJOB®S rail-mounted terminal blocks; gray	www.wago.com/2009-174
	Item no.: 2009-182 Testing tap; for max. 2.5 mm ² ; tool-free connection for individual test wires 0.08 - 2.5 mm; gray	www.wago.com/2009-182
	Item no.: 2001-511 Modular TOPJOB®S connector; modular; for jumper contact slot; 1-pole; 1,50 mm ² ; gray	www.wago.com/2001-511
	Item no.: 2001-554 Modular TOPJOB®S connector; modular; for jumper contact slot; 4-pole; 1,50 mm ² ; gray	www.wago.com/2001-554
	Item no.: 2001-549 Spacer module; modular; e.g., for bridging commoned terminal blocks; gray	www.wago.com/2001-549
	Item no.: 2001-556 Modular TOPJOB®S connector; modular; for jumper contact slot; 6-pole; 1,50 mm ² ; gray	www.wago.com/2001-556

Subject to changes. Please also observe the further product documentation!

	Item no.: 2001-557 Modular TOPJOB®S connector; modular; for jumper contact slot; 7-pole; 1,50 mm ² ; gray	www.wago.com/2001-557
	Item no.: 2001-553 Modular TOPJOB®S connector; modular; for jumper contact slot; 3-pole; 1,50 mm ² ; gray	www.wago.com/2001-553
	Item no.: 2001-552 Modular TOPJOB®S connector; modular; for jumper contact slot; 2-pole; 1,50 mm ² ; gray	www.wago.com/2001-552
	Item no.: 2001-558 Modular TOPJOB®S connector; modular; for jumper contact slot; 8-pole; 1,50 mm ² ; gray	www.wago.com/2001-558
	Item no.: 2001-560 Modular TOPJOB®S connector; modular; for jumper contact slot; 10-pole; 1,50 mm ² ; gray	www.wago.com/2001-560
	Item no.: 2001-555 Modular TOPJOB®S connector; modular; for jumper contact slot; 5-pole; 1,50 mm ² ; gray	www.wago.com/2001-555
	Item no.: 2001-559 Modular TOPJOB®S connector; modular; for jumper contact slot; 9-pole; 1,50 mm ² ; gray	www.wago.com/2001-559
Protective warning marker		
Cover		
	Item no.: 2001-115 Protective warning marker; for 5 terminal blocks; with high-voltage symbol, black; yellow	www.wago.com/2001-115
Marking accessories		
Marking strip		
	Item no.: 2009-110 Marking strips; for Smart Printer; on reel; not stretchable; plain; snap-on type; white	www.wago.com/2009-110
Marker		
	Item no.: 2009-114/000-002 WMB-Inline; for Smart Printer; 2000 pieces on roll; stretchable 4 - 4.2 mm; plain; snap-on type; yellow	www.wago.com/2009-114/000-002
	Item no.: 2009-114/000-005 WMB-Inline; for Smart Printer; 2000 pieces on roll; stretchable 4 - 4.2 mm; plain; snap-on type; red	www.wago.com/2009-114/000-005
	Item no.: 2009-114/000-007 WMB-Inline; for Smart Printer; 2000 pieces on roll; stretchable 4 - 4.2 mm; plain; snap-on type; gray	www.wago.com/2009-114/000-007
	Item no.: 2009-114/000-023 WMB-Inline; for Smart Printer; 2000 pieces on roll; stretchable 4 - 4.2 mm; plain; snap-on type; green	www.wago.com/2009-114/000-023

Subject to changes. Please also observe the further product documentation!

	Item no.: 2009-114/000-006 WMB-Inline; for Smart Printer; 2000 pieces on roll; stretchable 4 - 4.2 mm; plain; snap-on type; blue	www.wago.com/2009-114/000-006
	Item no.: 2009-114/000-024 WMB-Inline; for Smart Printer; 2000 pieces on roll; stretchable 4 - 4.2 mm; plain; snap-on type; violet	www.wago.com/2009-114/000-024
	Item no.: 2009-114/000-012 WMB-Inline; for Smart Printer; 2000 pieces on roll; stretchable 4 - 4.2 mm; plain; snap-on type; orange	www.wago.com/2009-114/000-012
	Item no.: 2009-114 WMB-Inline; for Smart Printer; 2000 pieces on roll; stretchable 4 - 4.2 mm; plain; snap-on type; white	www.wago.com/2009-114
	Item no.: 793-4501/000-002 WMB marking card; as card; stretchable 4 - 4.2 mm; plain; snap-on type; yellow	www.wago.com/793-4501/000-002
	Item no.: 793-4501/000-006 WMB marking card; as card; stretchable 4 - 4.2 mm; plain; snap-on type; blue	www.wago.com/793-4501/000-006
	Item no.: 793-4501 WMB marking card; as card; stretchable 4 - 4.2 mm; plain; snap-on type; white	www.wago.com/793-4501
	Item no.: 793-4501/000-023 WMB marking card; as card; stretchable 4 - 4.2 mm; plain; snap-on type; green	www.wago.com/793-4501/000-023
	Item no.: 793-4501/000-024 WMB marking card; as card; stretchable 4 - 4.2 mm; plain; snap-on type; violet	www.wago.com/793-4501/000-024
	Item no.: 793-4501/000-005 WMB marking card; as card; stretchable 4 - 4.2 mm; plain; snap-on type; red	www.wago.com/793-4501/000-005
	Item no.: 793-4501/000-007 WMB marking card; as card; stretchable 4 - 4.2 mm; plain; snap-on type; gray	www.wago.com/793-4501/000-007
	Item no.: 793-4501/000-012 WMB marking card; as card; stretchable 4 - 4.2 mm; plain; snap-on type; orange	www.wago.com/793-4501/000-012

Subject to changes. Please also observe the further product documentation!







Item no.: 793-4501/000-017

WMB marking card; as card; stretchable 4 - 4.2 mm; plain; snap-on type; light green

www.wago.com/793-4501/000-017

Ferrule

Ferrule

	Item no.: 216-241 Ferrule; Sleeve for 0.5 mm ² / 20 AWG; insulated; electro-tin plated; electrolytic copper; gastight crimped; acc. to DIN 46228, Part 4/09.90; white	www.wago.com/216-241
	Item no.: 216-242 Ferrule; Sleeve for 0.75 mm ² / 18 AWG; insulated; electro-tin plated; electrolytic copper; gastight crimped; acc. to DIN 46228, Part 4/09.90; gray	www.wago.com/216-242
	Item no.: 216-243 Ferrule; Sleeve for 1 mm ² / AWG 18; insulated; electro-tin plated; electrolytic copper; gastight crimped; acc. to DIN 46228, Part 4/09.90; red	www.wago.com/216-243
	Item no.: 216-244 Ferrule; Sleeve for 1.5 mm ² / AWG 16; insulated; electro-tin plated; electrolytic copper; gastight crimped; acc. to DIN 46228, Part 4/09.90; black	www.wago.com/216-244

Insulation stop

Insulation stop



Item no.: 2001-171

Insulation stop; 0.25 - 0.5 mm²; 5 pieces/strip; light graywww.wago.com/2001-171

Downloads

Documentation

Bid Text

2001-1302 X81 - Datei	2019 Feb 19	xml 4.0 kB	Download
2001-1302 docx - Datei	2018 Aug 2	docx 15.1 kB	Download

Additional Information

Technical Section Technical explanations	pdf 2.2 MB	Download
---	---------------	----------

CAD/CAE-Data

CAD data

2D/3D Models 2001-1302

Subject to changes. Please also observe the further product documentation!

WAGO GmbH & Co. KG

Hansastr. 27

32423 Minden

Phone: +49571 887-0 | Fax: +49571 887-169

Email: info.de@wago.com | Web: www.wago.com

Do you have any questions about our products?

We are always happy to take your call at +49 (571) 887-44222.

[URL](#) [Download](#)

CAE data

EPLAN Data Portal 2001-1302

[URL](#) [Download](#)

ZUKEN Portal 2001-1302

[URL](#) [Download](#)

WSCAD Universe 2001-1302

[URL](#) [Download](#)

Environmental Product Compliance

Compliance Search

Environmental Product Compliance 2001-1302

[URL](#) [Download](#)

3-conductor through terminal block; 1.5 mm²; suitable for Ex e II applications; side and center marking; for DIN-rail 35 x 15 and 35 x 7.5; Push-in CAGE CLAMP®; 1,50 mm²; orange

Installation Notes

Conductor termination

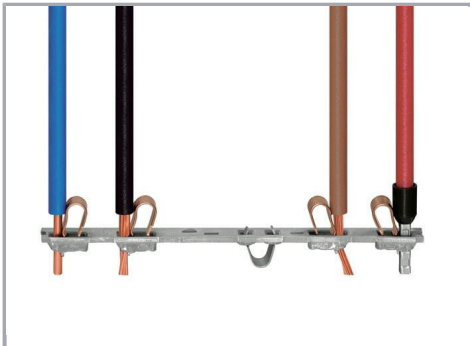

All conductor types at a glance

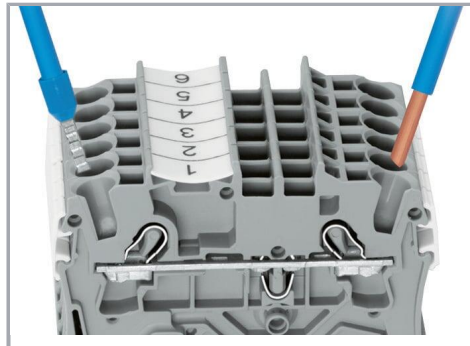

Push-in termination of solid and ferruled conductors

Subject to changes. Please also observe the further product documentation!

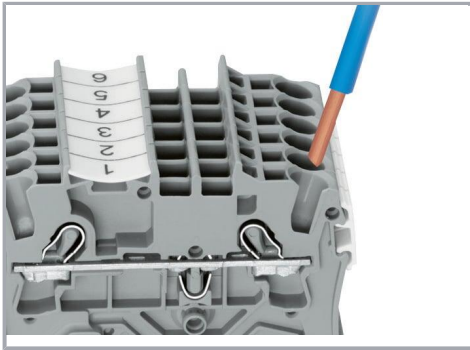

Inserting a conductor via push-in termination:

Solid conductors with cross-sections from either one size above, or up to two sizes below, the rated cross-section can be simply pushed in – no tools needed.

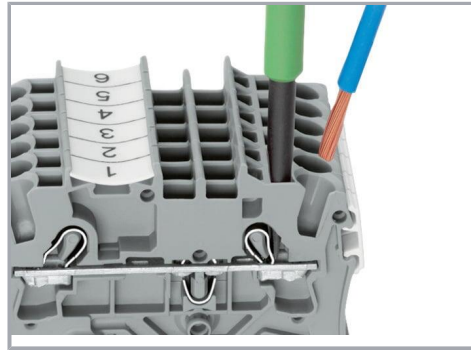

Inserting a conductor via operating tool:

Connecting fine-stranded conductors without ferrules, or small cross-sectional conductors that cannot be pushed in, is performed similarly to the original CAGE CLAMP® – just use an operating tool.

Advantage:

To open the clamp, the operating tool is inserted vertically. The conductor entry is less than 15 degrees for easier wiring.

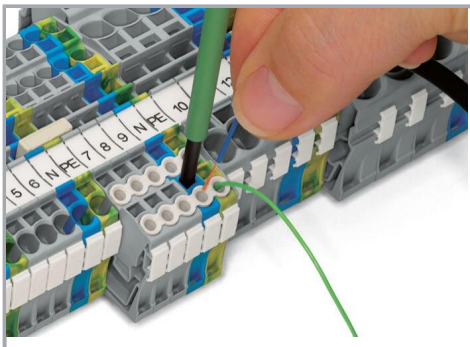

Conductor termination – insulation stop

Commoning

Subject to changes. Please also observe the further product documentation!

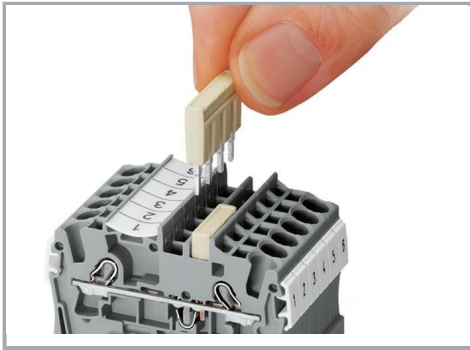

Insert push-in type jumper bar and push down until it hits backstop.

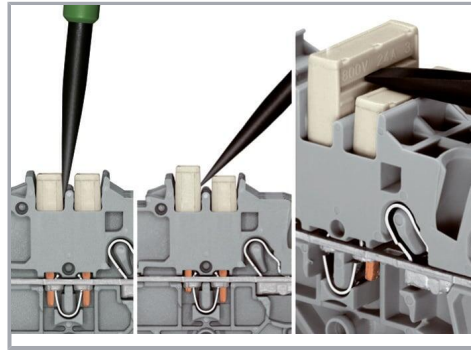

Removing a push-in type jumper bar:

Insert the operating tool between the jumper and partition wall of the dual jumper slots, then lift up the jumper.

Place the operating tool in the center of jumpers for up to five contacts (see above), or alternately on both sides for jumpers with more than five contacts.

Commoning

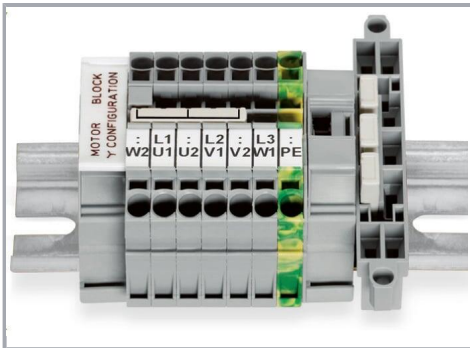

This star point jumper has been specially developed to create a "star point" and is used on motor terminal boards equipped with Rail-Mount Terminal Blocks TOPJOB® S.

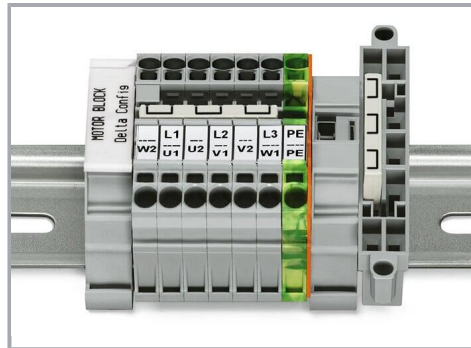

This delta jumper has been specially developed to create a delta configuration and is used on motor terminal boards equipped with rail-mount terminal blocks TOPJOB® S.

Subject to changes. Please also observe the further product documentation!

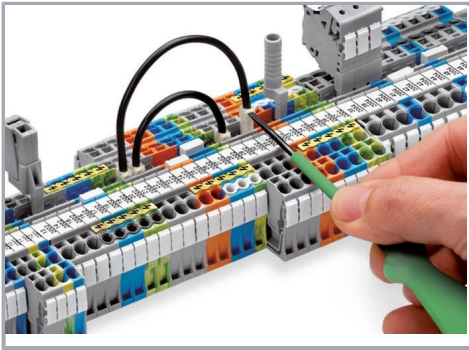

Push down the wire jumper until fully inserted. Lift the jumper with an operating tool for rewiring.

Commoning

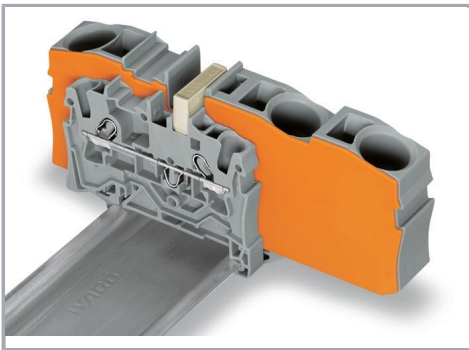

Step-down jumpers common terminal blocks of different sizes, without losing a conductor clamping point. This can be beneficial on long conductor runs where voltage drop can be a problem. A large conductor can be easily connected to smaller conductors at the distribution point.

Commoning may be made in either direction using the special thin end plate to cover the open side. Additional through terminal blocks having a smaller cross-section may be commoned using push-in type jumper bars.

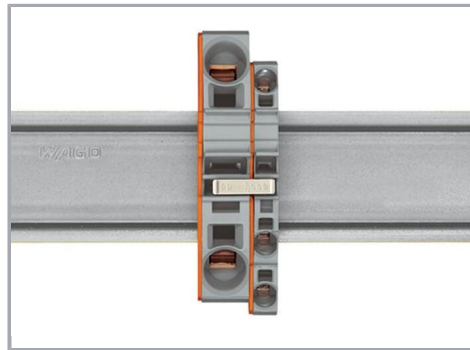

Using step-down jumpers, an end plate must be inserted between the terminal blocks to be commoned.

Subject to changes. Please also observe the further product documentation!

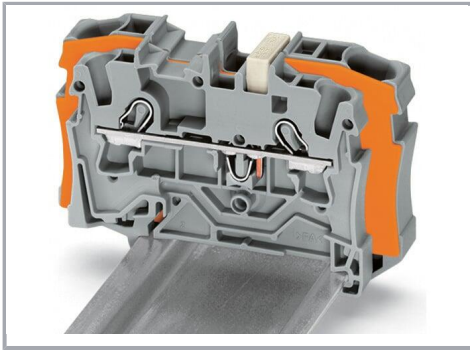

Step-down jumper (2006-499) commons 6 /4 mm² (10/12 AWG) terminal blocks (2006 /2004 Series) with 4/2.5/1.5 mm² (AWG 12/14 /16) terminal blocks (2004/2002/2001 Series).

Step-down jumper (2016-499) commons 16 /10 mm² (16/8 AWG) terminal blocks (2016 /2010 Series) with 10/6/4/2.5 mm² (8/10/12/14 AWG) terminal blocks (2010/2006/2004/2002 Series).

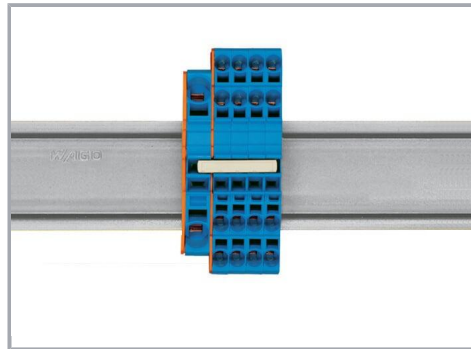
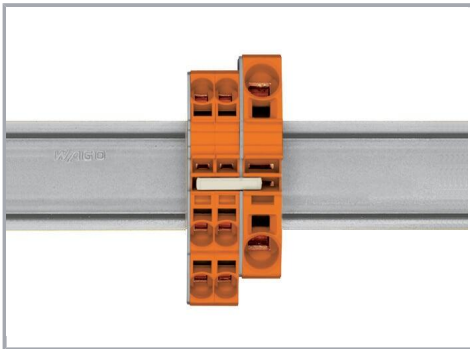

Stepping down via push-in type jumper bar:

Stepping down via push-in type jumper bar:

Commoning via open terminal side with end plate allows jumpering over two cross-section sizes for 16 mm² (6 AWG) and 10 mm² (8 AWG) and one cross-section size for 6/4/2.5 mm² (10 /12/14 AWG). An example: from 16 mm² (6 AWG) to 6 mm² (10 AWG) (see illustration above) or from 10 mm² (8 AWG) to 4 mm² (12 AWG).

Commoning via closed terminal side with end plate allows jumpering over two cross-section sizes, e.g., from 16 mm² (6 AWG) to 6 mm² (10 AWG) or from 6 mm² (10 AWG) to 2.5 mm² (14 AWG) (see illustration above).

Subject to changes. Please also observe the further product documentation!

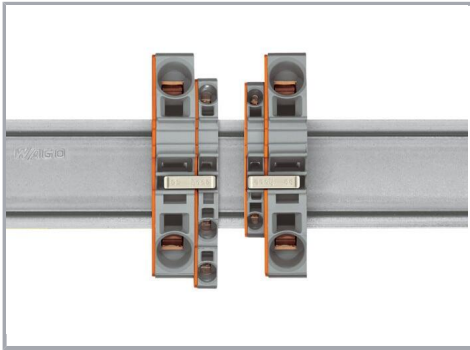

Note:

The total current of the outgoing circuits must not exceed the nominal current of the step-down jumper/push-in type jumper bar.

Testing

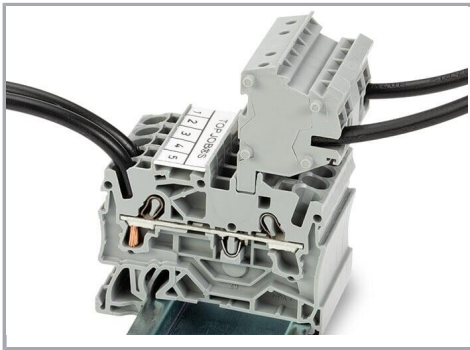

The modular TOPJOB® S connectors also connect conductors of the same size as the terminal blocks being used.

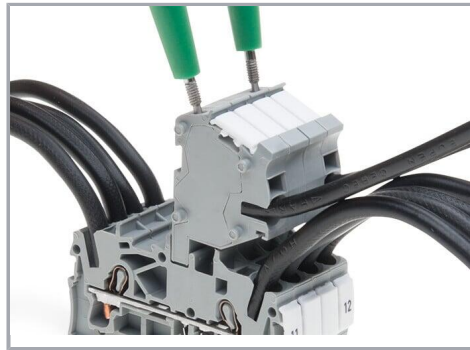

TOPJOB® S Connectors with a 2 mm Ø test socket for testing voltage via 2-pole voltage tester

Subject to changes. Please also observe the further product documentation!

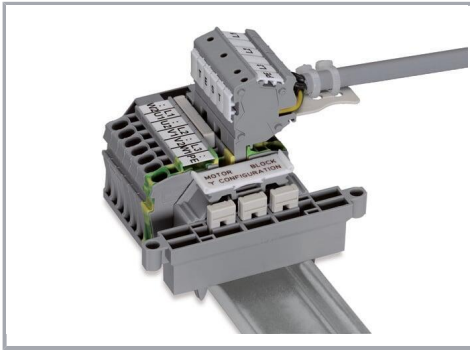

Rail-mount terminal block assembly for electric motor wiring

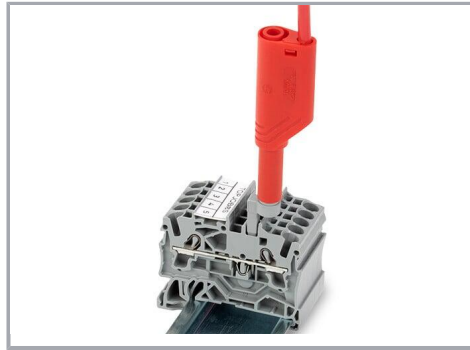

Test plug adapter (2009-174, CAT I) for 4 mm Ø plugs – compatible with 2000 to 2016 Series

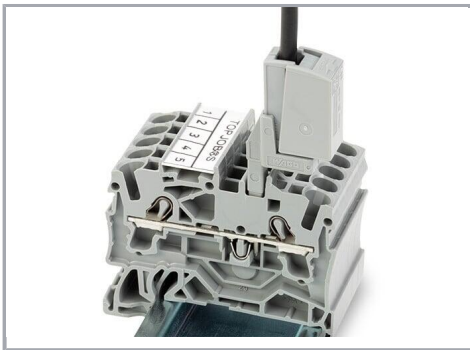

Testing tap (2009-182) for tool-free connection of test cables up to 2.5 mm² (12 AWG) – compatible with 2000 to 2016 Series

Marking

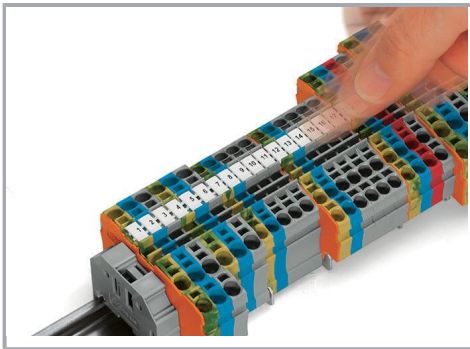

Snapping WMB Inline markers into marker slots.

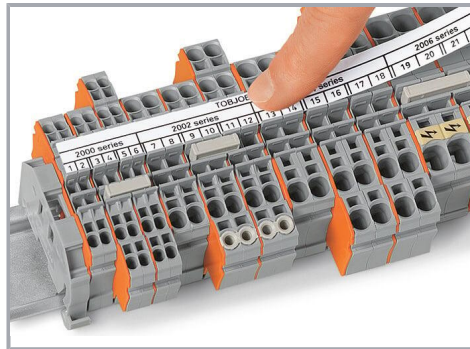

Subject to changes. Please also observe the further product documentation!



TOPJOB® S 2009-193 Group Marker Carrier (equipped with a marking strip) for all 2001 to 2016 Series TOPJOB® S Rail-Mount Terminal Blocks

Do not use on an end plate!

Ex application

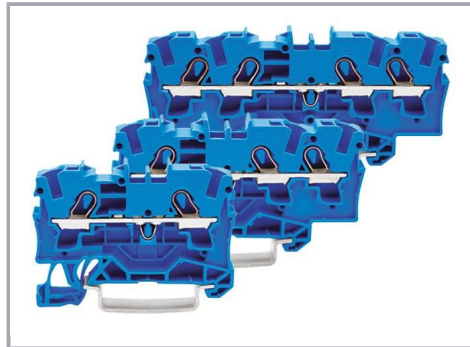
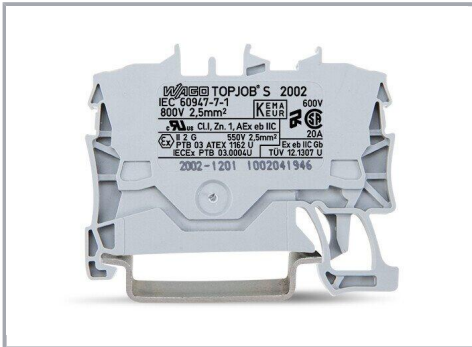

Through terminal blocks with a blue insulated housing are suitable for Ex i applications.

Subject to changes. Please also observe the further product documentation!

WAGO GmbH & Co. KG
Hansastr. 27
32423 Minden
Phone: +49571 887-0 | Fax: +49571 887-169
Email: info.de@wago.com | Web: www.wago.com

Do you have any questions about our products?
We are always happy to take your call at +49 (571) 887-44222.



All through and ground conductor terminal blocks are suitable for Ex e II applications.

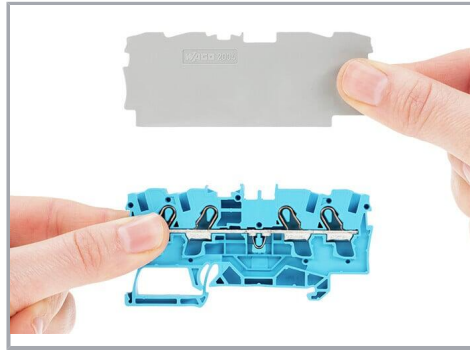

Separator plate for Ex e/Ex i applications

An end plate must be applied to the terminal block located directly behind an Ex e/Ex i separator plate.



Ex e II/Ex i terminal strip

Note:

The movable feet of terminal blocks and separator plates must face the same direction.



A separator plate is located between the Ex e II and Ex i terminal strip.

End plate

Ex e II terminal blocks

Separator plate for Ex e/Ex i applications

End plate

Ex i terminal blocks

According to EN 50020, a minimum distance of 50 mm must be kept between live parts of Ex e and Ex i circuits. The use of Ex e/Ex i separators is a space-saving solution when Ex e and Ex i terminal blocks are mounted on a common DIN-rail.

Product family

Subject to changes. Please also observe the further product documentation!



TOPJOB® S

TOPJOB® S: In various industrial applications and modern building installations, WAGO's wide and versatile range of rail-mount terminal blocks provides more than just reliable electrical connections.

[Show all products from the family](#)

Subject to changes. Please also observe the further product documentation!

WAGO GmbH & Co. KG
Hansastr. 27
32423 Minden
Phone: +49571 887-0 | Fax: +49571 887-169
Email: info.de@wago.com | Web: www.wago.com

Do you have any questions about our products?
We are always happy to take your call at +49 (571) 887-44222.