

LOC		DIST		REVISIONS			
P	LTN	DESCRIPTION	DATE	DWN	APVD		
B1		REVISED PER ECO-16-014766	12OCT2016	RS	GJ		

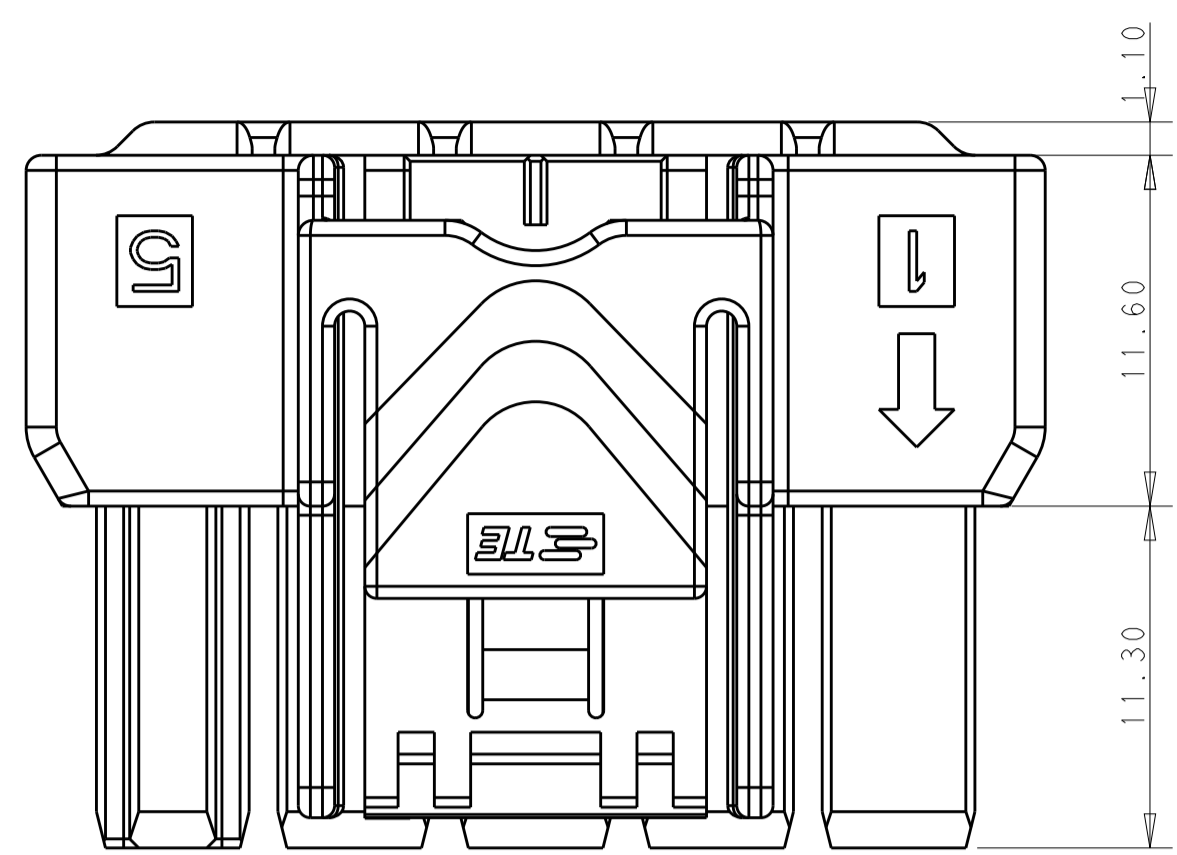

POS.	DIM. A
3*5	33.70
3*4	27.70
3*3	21.70

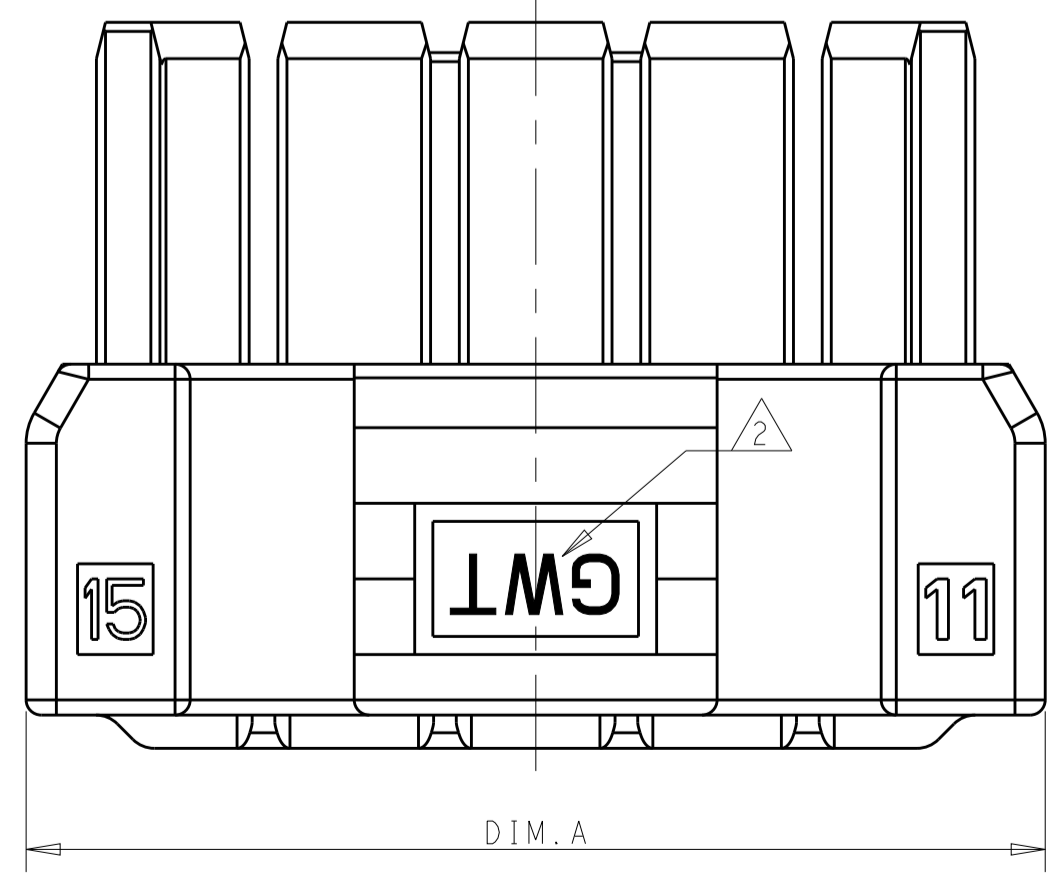
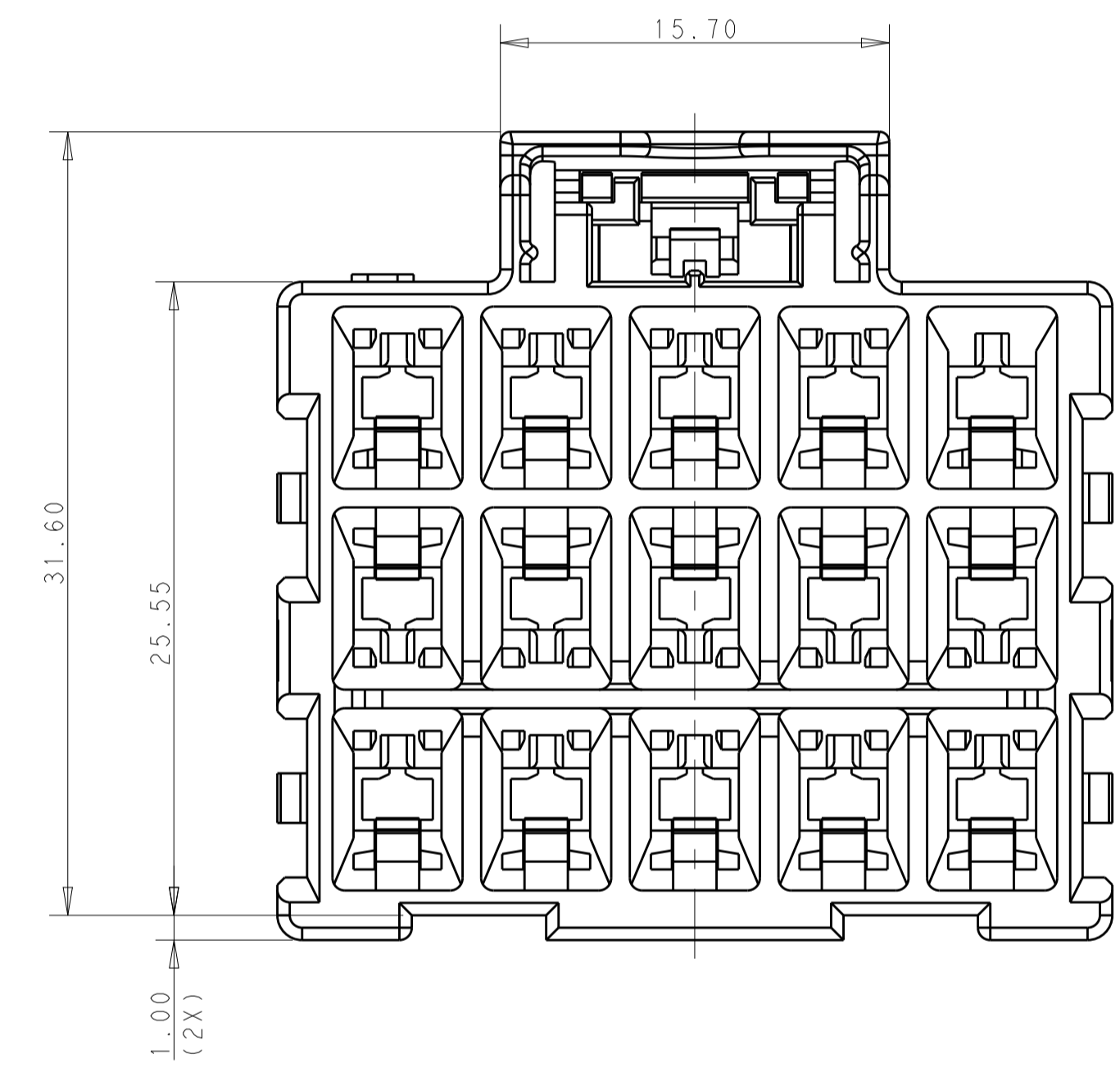
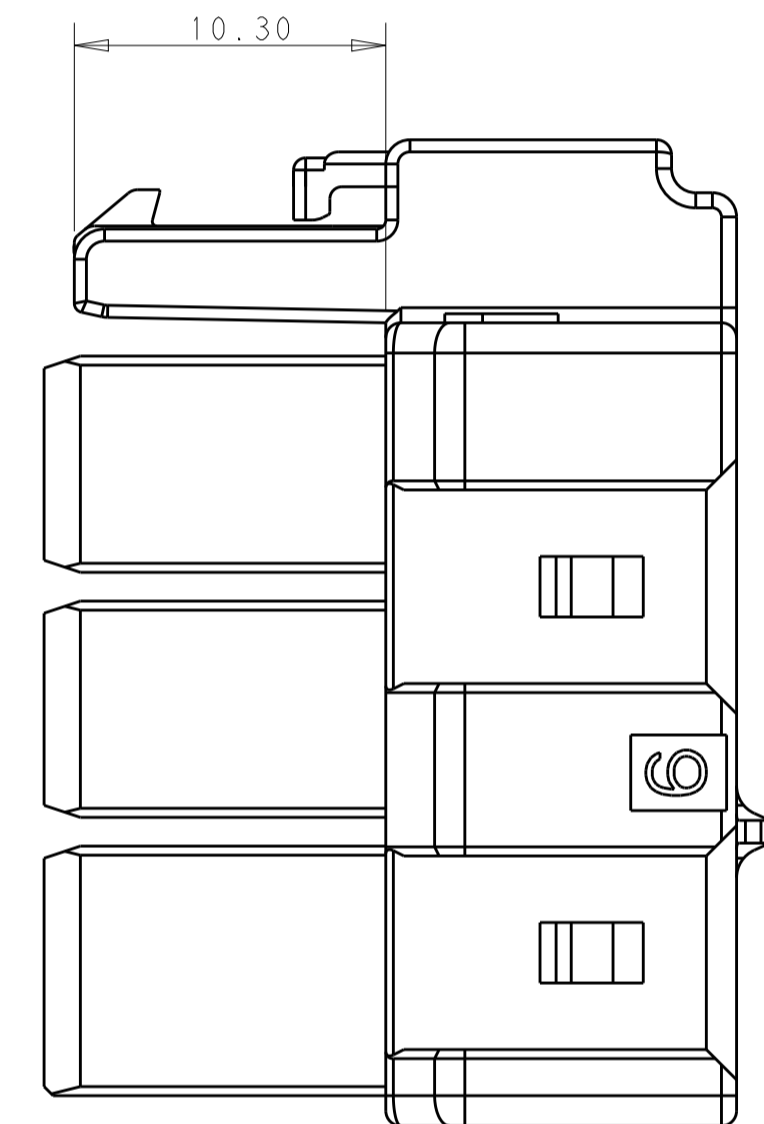
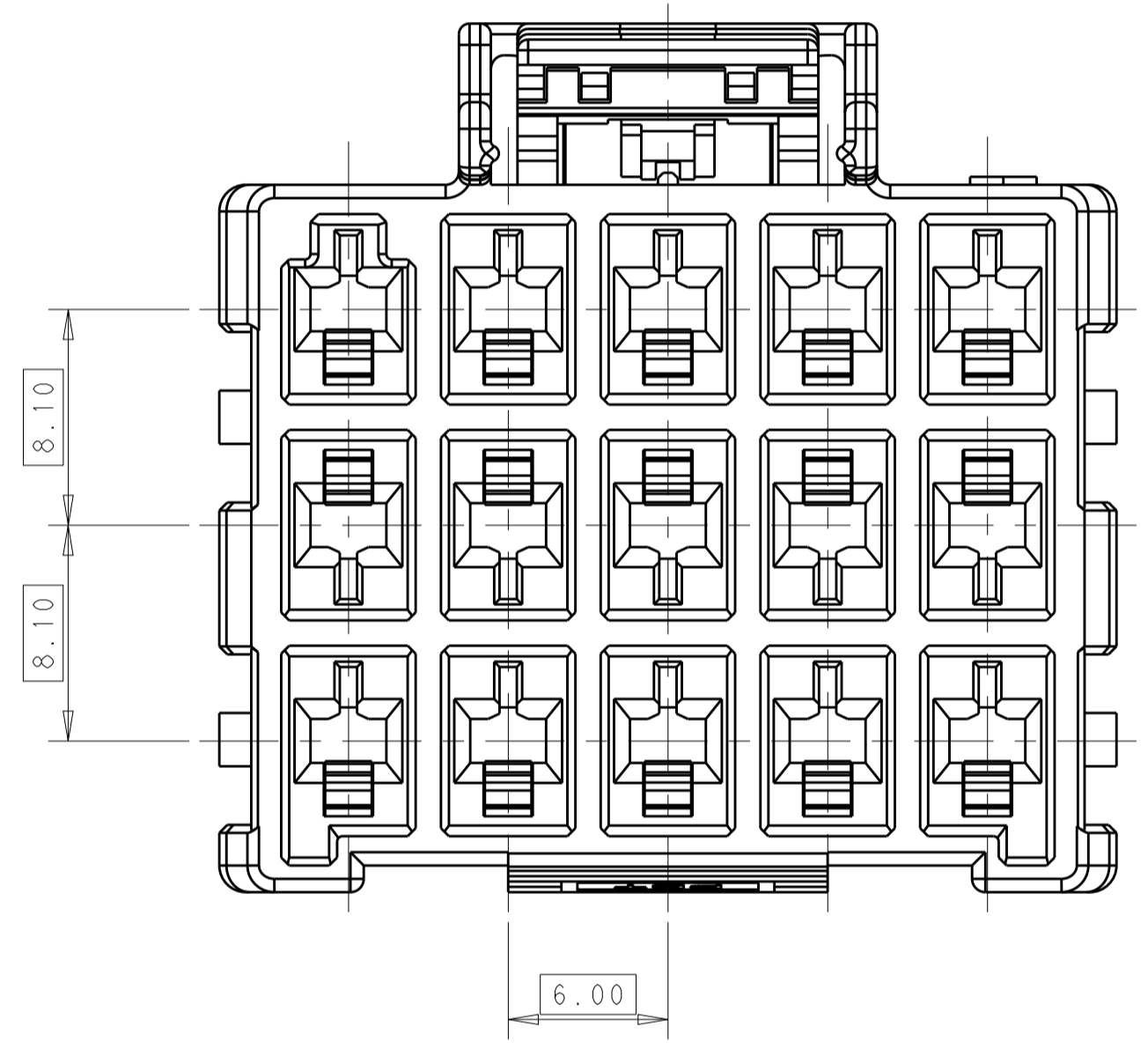

1 MATERIAL:
 LEVEL A: PA6, COMPLY WITH GLOW WIRE REQUIREMENTS FOR PARTS OF NON-METALLIC MATERIAL SUPPORTING A CURRENT-CARRYING CONNECTION DETAILED IN IEC 60335-1, SECTION 30 (GWT), UL 94V-0
 LEVEL B: PBT, HOT WIRE IGNITION (HWI) VERSION ARE MOLDED IN A RESIN THAT COMPLIES WITH TE HOT WIRE IGNITION TEST 109-32026 AND ARE RECOMMENDED FOR USE WITH HWI HOUSINGS THAT ALSO COMPLY, UL 94V-0

2 MATERIAL MARK:
 LEVEL A: GWT, LEVEL B: HWT

3. APPLICABLE CONTACT P/N
 RECEPTACLE CONTACT: 1971237/1971779/81/83/85/87-*; 2238066-*

4. MATING CONN. P/N
 CAP HSG: *-2232356/60-*
 DOUBLE ROW TPA: *-1971778-*; SINGLE ROW TPA: *-1971777-*

5. THIS PRODUCT HAS NOT COMPLETED VALIDATION TESTING.

THIS DRAWING IS A CONTROLLED DOCUMENT.		DWN: TOMMY_WU 26MAR2013	TE Connectivity
DIMENSIONS:		CHK: HAPYE_WU 26MAR2013	
TOLERANCES UNLESS OTHERWISE SPECIFIED:		APVD: YUHHONG_MAO 26MAR2013	
mm	0 PLC ±	PRODUCT SPEC	NAME: PLUG HOUSING, TRIPLE ROW POWER TRIPLE LOCK
	1 PLC ±0.35	108-106118	
	2 PLC ±0.25	APPLICATION SPEC	SIZE: CAGE CODE: DRAWING NO: RESTRICTED TO
	3 PLC ±	114-106118	A100779C=2232357
	4 PLC ±	WEIGHT: -	Customer Drawing
	ANGLES ±	SCALE: 3:1	SHEET 1 OF 2
MATERIAL	FINISH	REV: B1	

REVISONS		DATE	OWN	APVD
LOC	DIST			

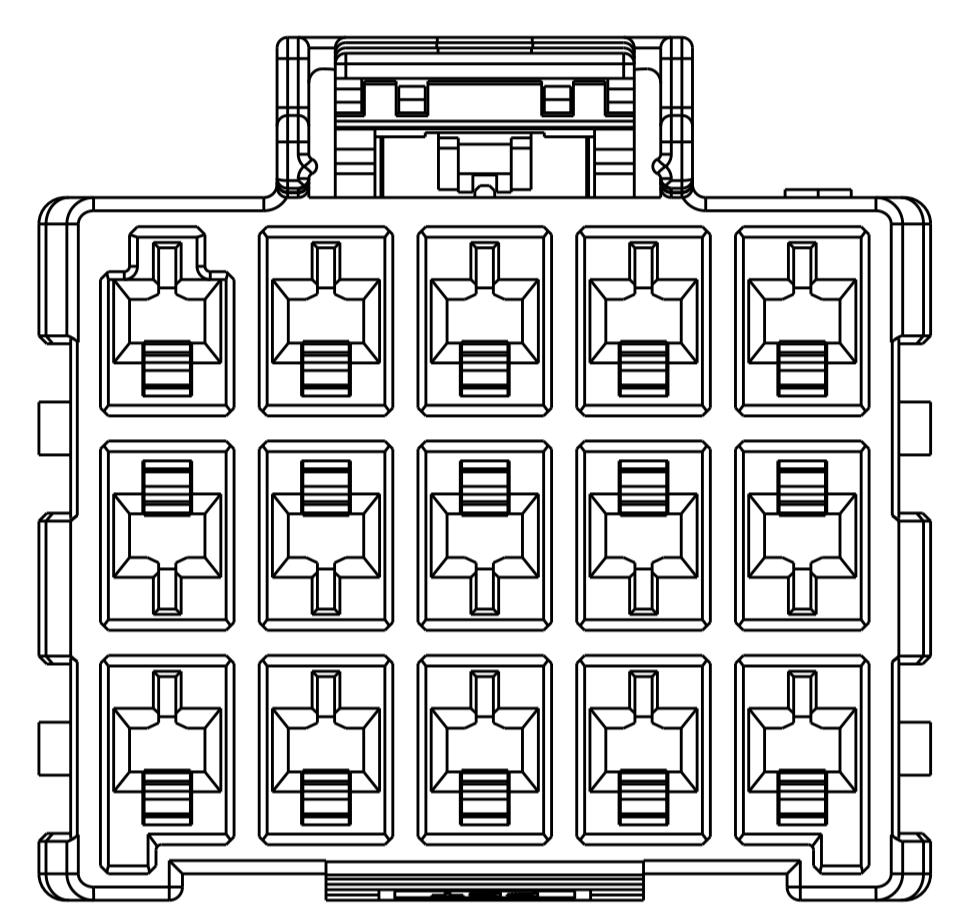
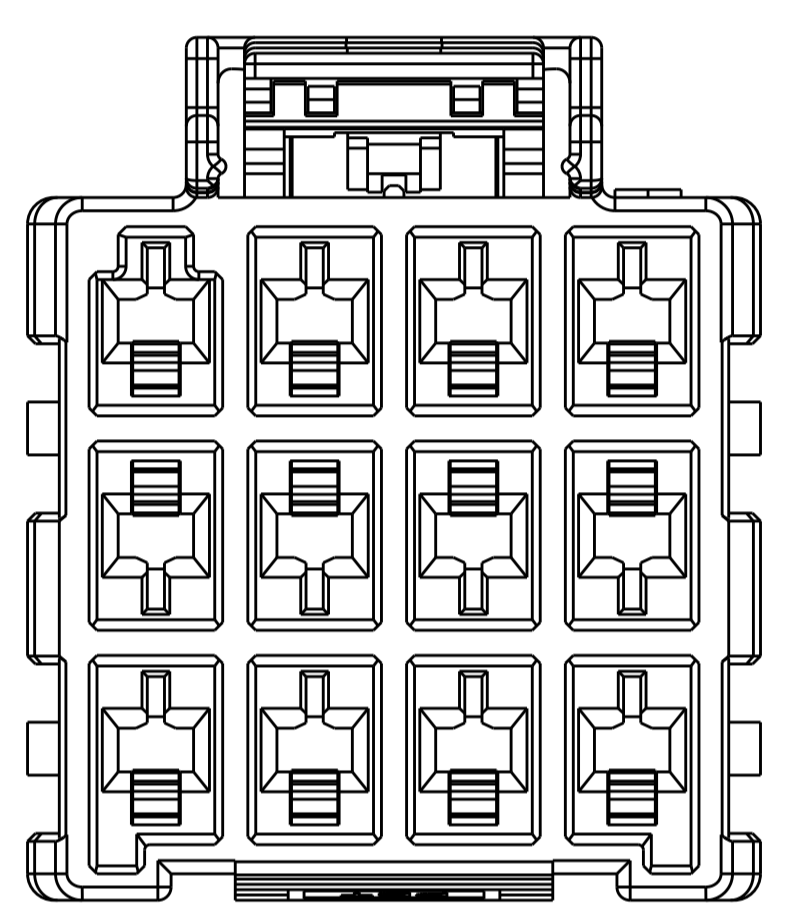
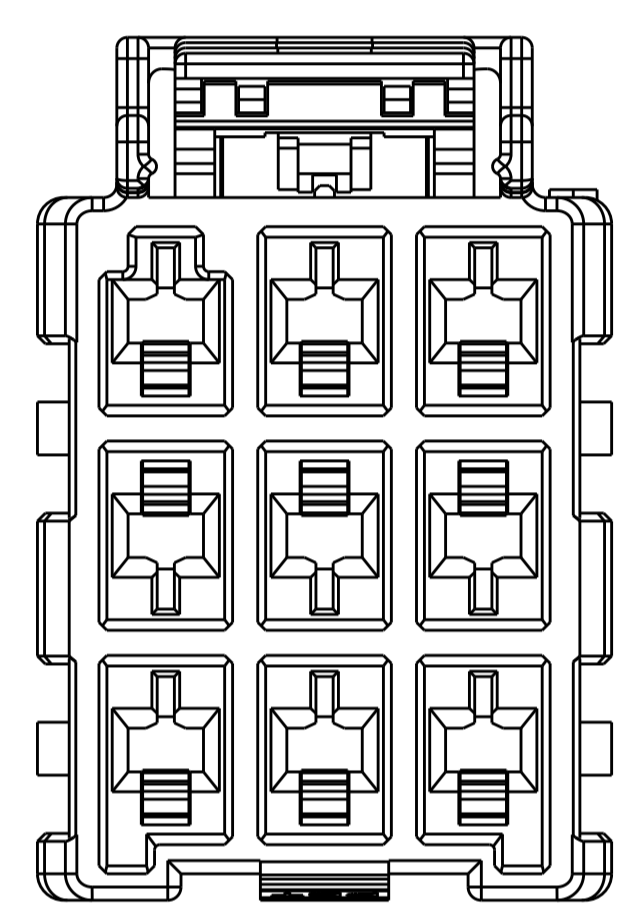
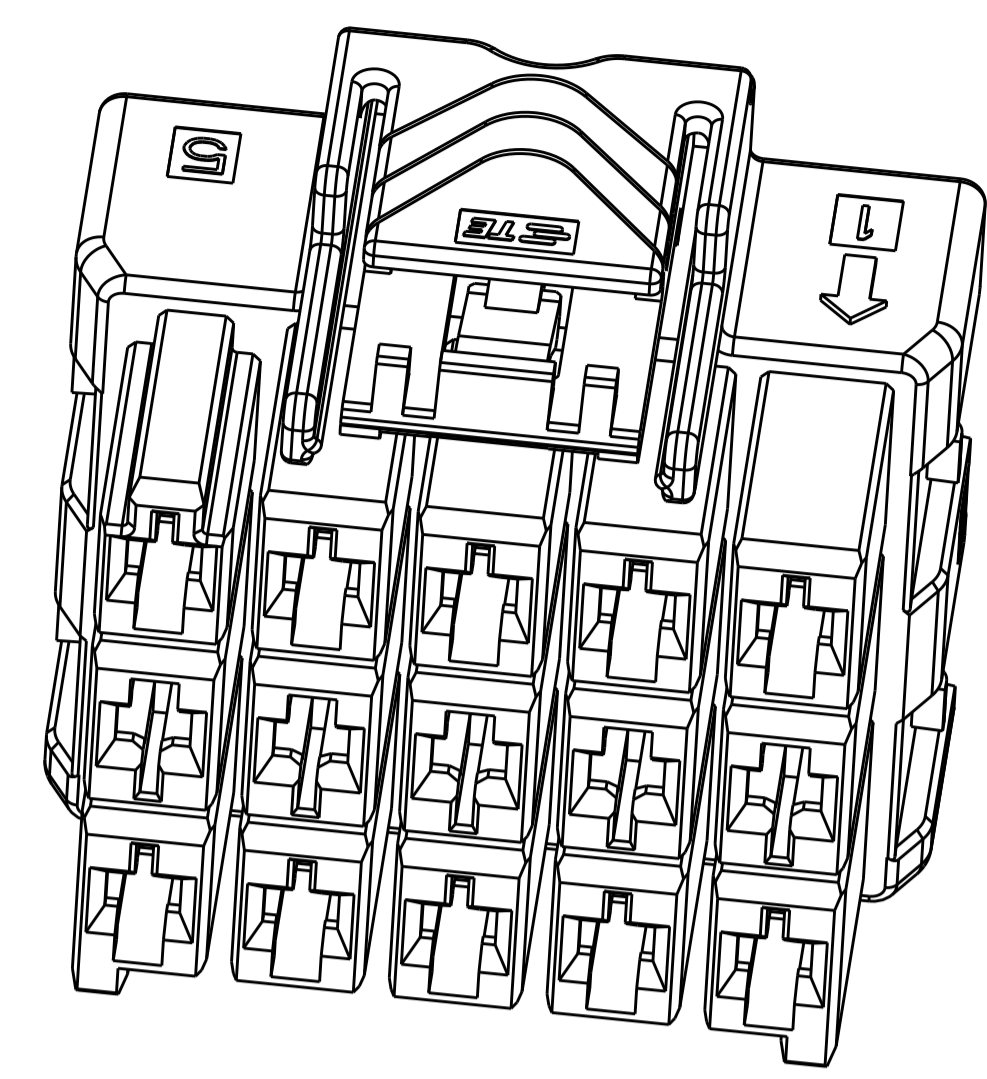
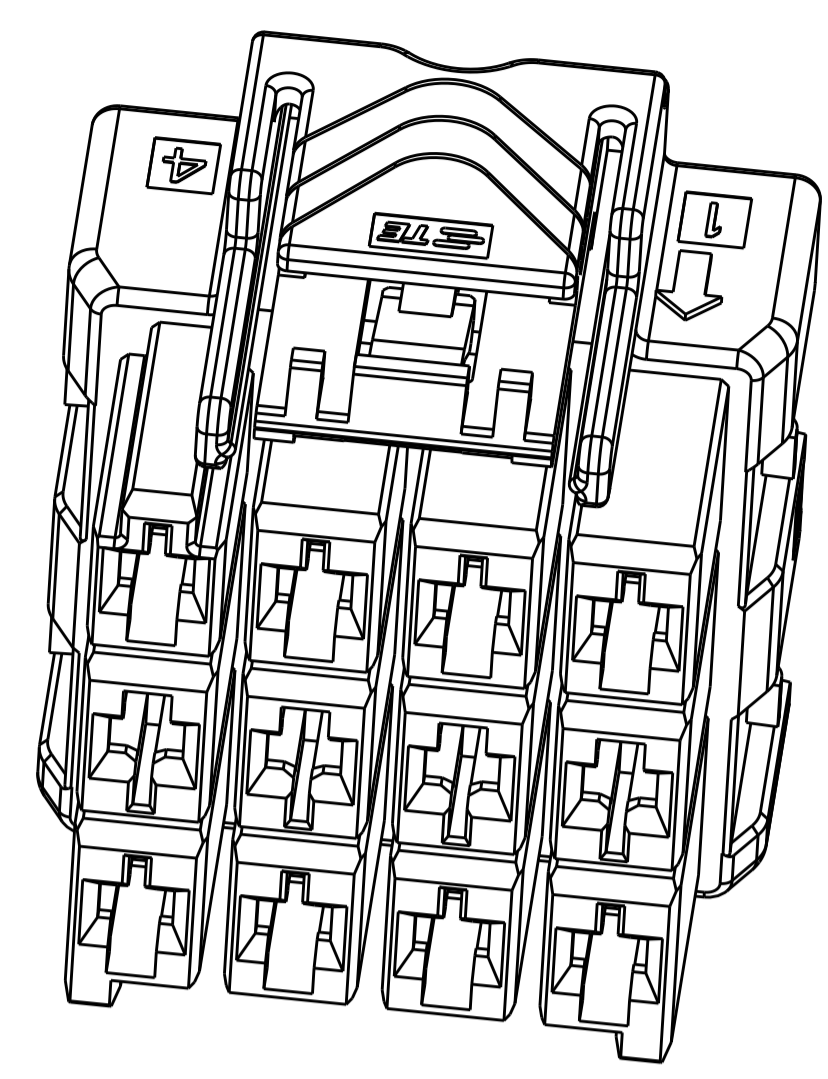
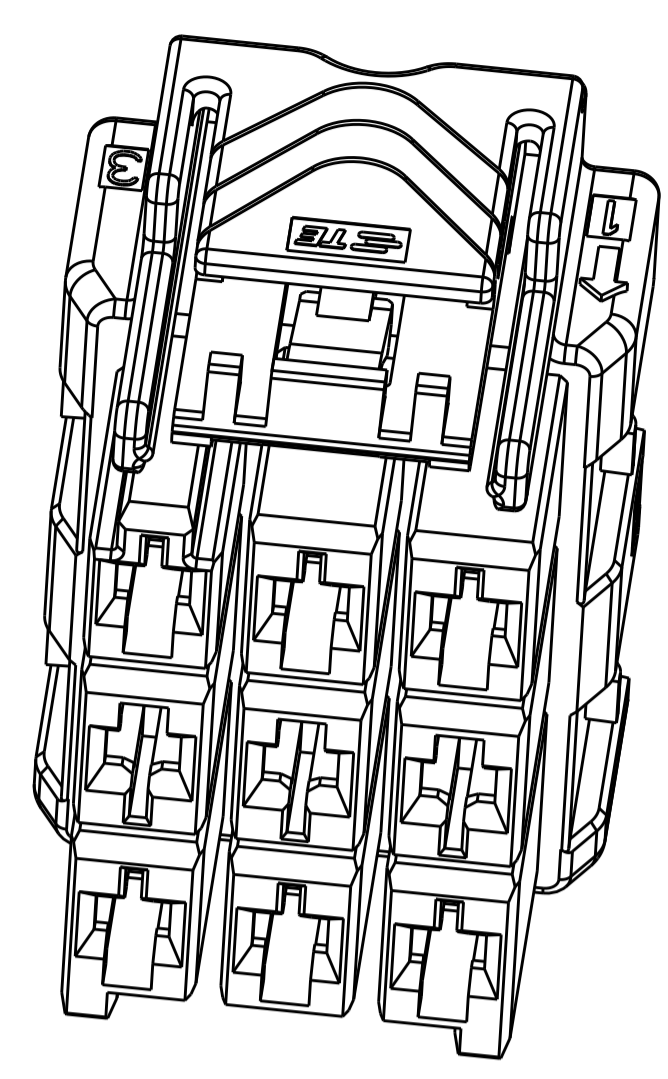

POS.	MATERIAL	COLOR	KEY	P/N
3*5	LEVEL A	DARK GREY	KEY A	5-2232357-7
		BROWN	KEY B	6-2232357-7
		GREEN	KEY C	7-2232357-7
		ORANGE	KEY D	8-2232357-7
3*4	LEVEL A	BLACK	KEY A	1-2232357-5
		DARK GREY	KEY A	5-2232357-4
		BROWN	KEY B	6-2232357-4
		GREEN	KEY C	7-2232357-4
3*3	LEVEL A	ORANGE	KEY D	8-2232357-4
		BLACK	KEY A	1-2232357-4
		DARK GREY	KEY A	5-2232357-3
		BROWN	KEY B	6-2232357-3
3*3	LEVEL A	GREEN	KEY C	7-2232357-3
		ORANGE	KEY D	8-2232357-3
		BLACK	KEY A	1-2232357-6

3*3 POSITIONS

3*4 POSITIONS

3*5 POSITIONS

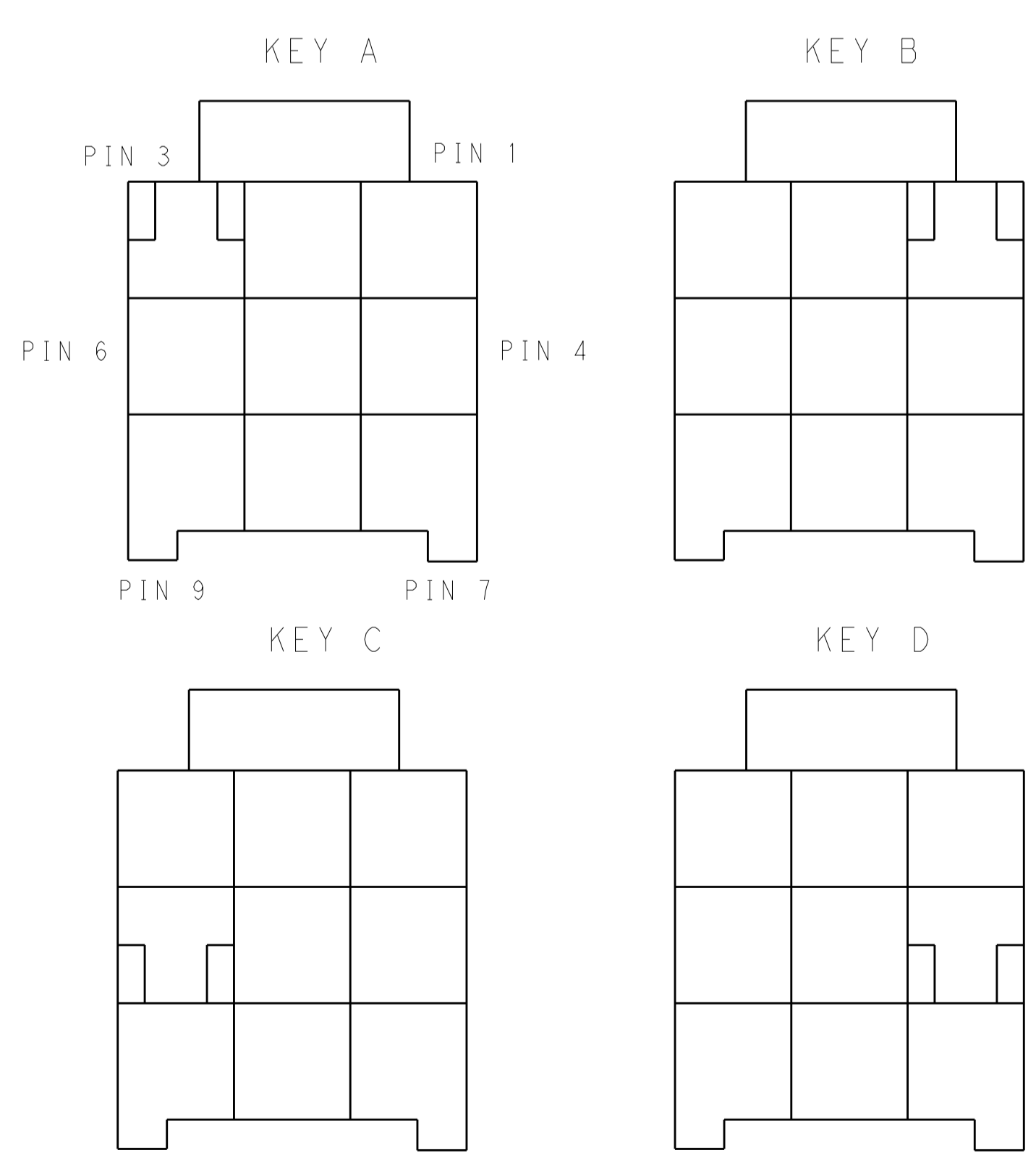

KEYING FOR 3*3 POS.

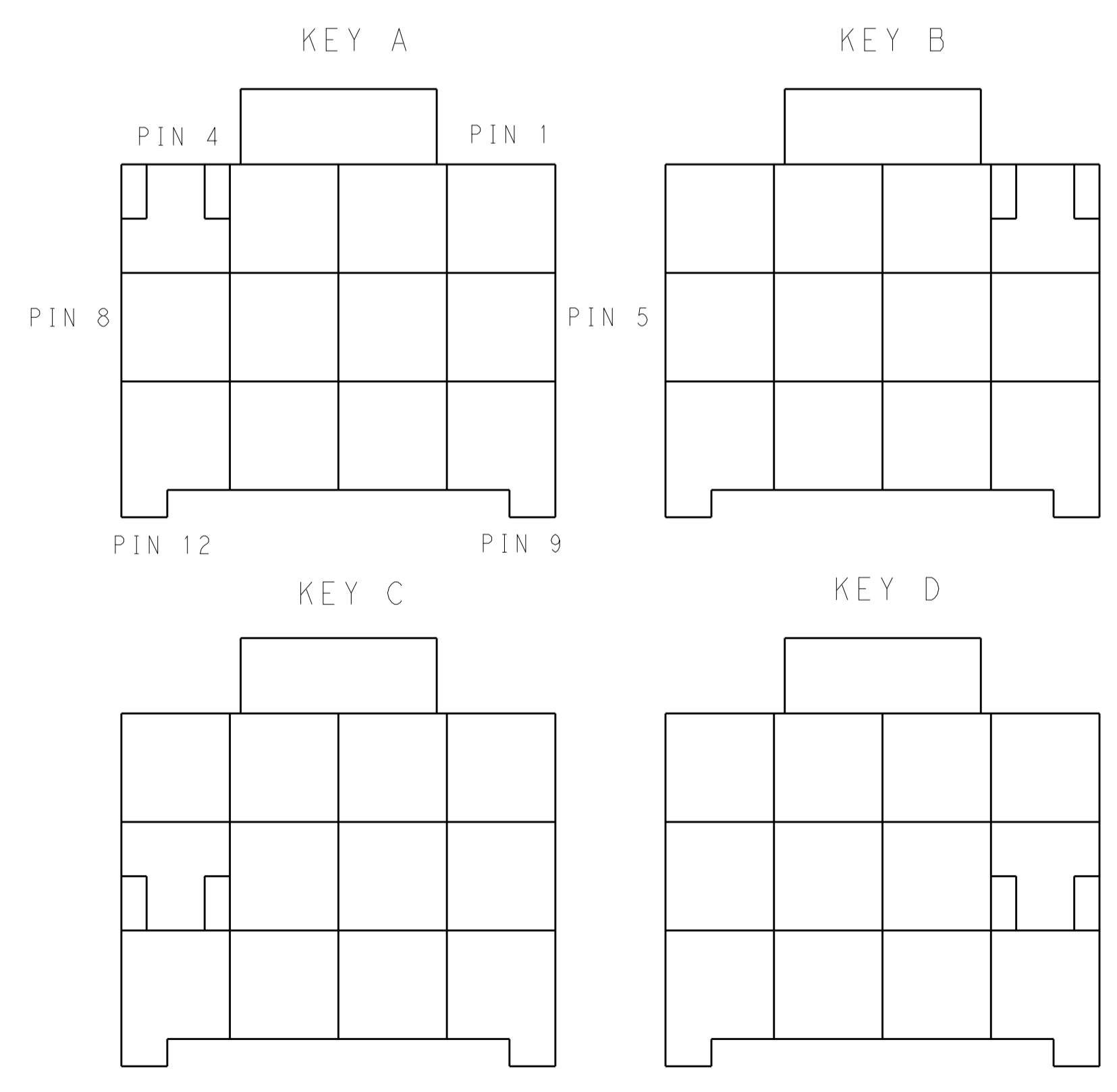

KEYING FOR 3*4 POS.

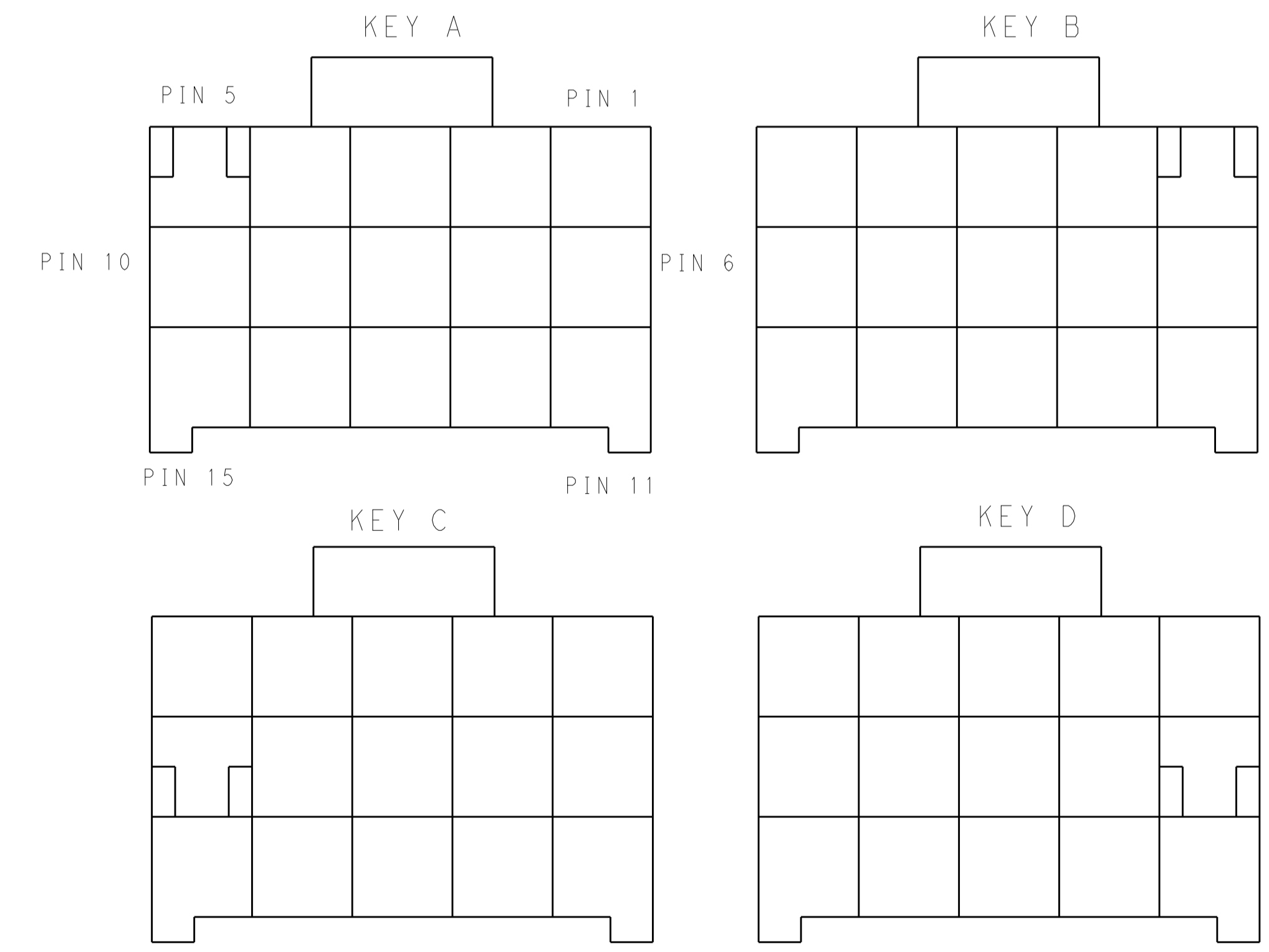

KEYING FOR 3*5 POS.

THIS DRAWING IS A CONTROLLED DOCUMENT.

DIMENSIONS:	TOLERANCES UNLESS OTHERWISE SPECIFIED:	OWN: TOMMY_WU 26MAR2013	CHK: HAPYE_WU 26MAR2013	APVD: YIHONG_MAO 26MAR2013
mm	0 PLC ±.1 1 PLC ±0.35 2 PLC ±0.25 3 PLC ±.1 4 PLC ±.1 ANGLES ±.1	PRODUCT SPEC: 108-106118	APPLICATION SPEC: 114-106118	WEIGHT: -
MATERIAL:	FINISH:	SIZE: A1	CAGE CODE: 00779	DRAWING NO: 2232357

Customer Drawing

TE Connectivity

PLUG HOUSING, TRIPLE ROW
POWER TRIPLE LOCK

RESTRICTED TO

SCALE: - SHEET 2 OF 2 REV B1