

## LAURA-D-PG

~15° diffused spot beam. Assembly with white holder and location pins.

### TECHNICAL SPECIFICATIONS:

Dimensions	21.6 mm
Height	13.1 mm
Fastening	glue, pin
Colour	white
Box size	476 x 273 x 292 mm
Box weight	11.1 kg
Quantity in Box	1960 pcs
ROHS compliant	yes ⓘ



### MATERIAL SPECIFICATIONS:

Component	Type	Material	Colour
LAURA-D	Single lens	PMMA	clear
LAURA-HLD-PIN	Holder	PC	

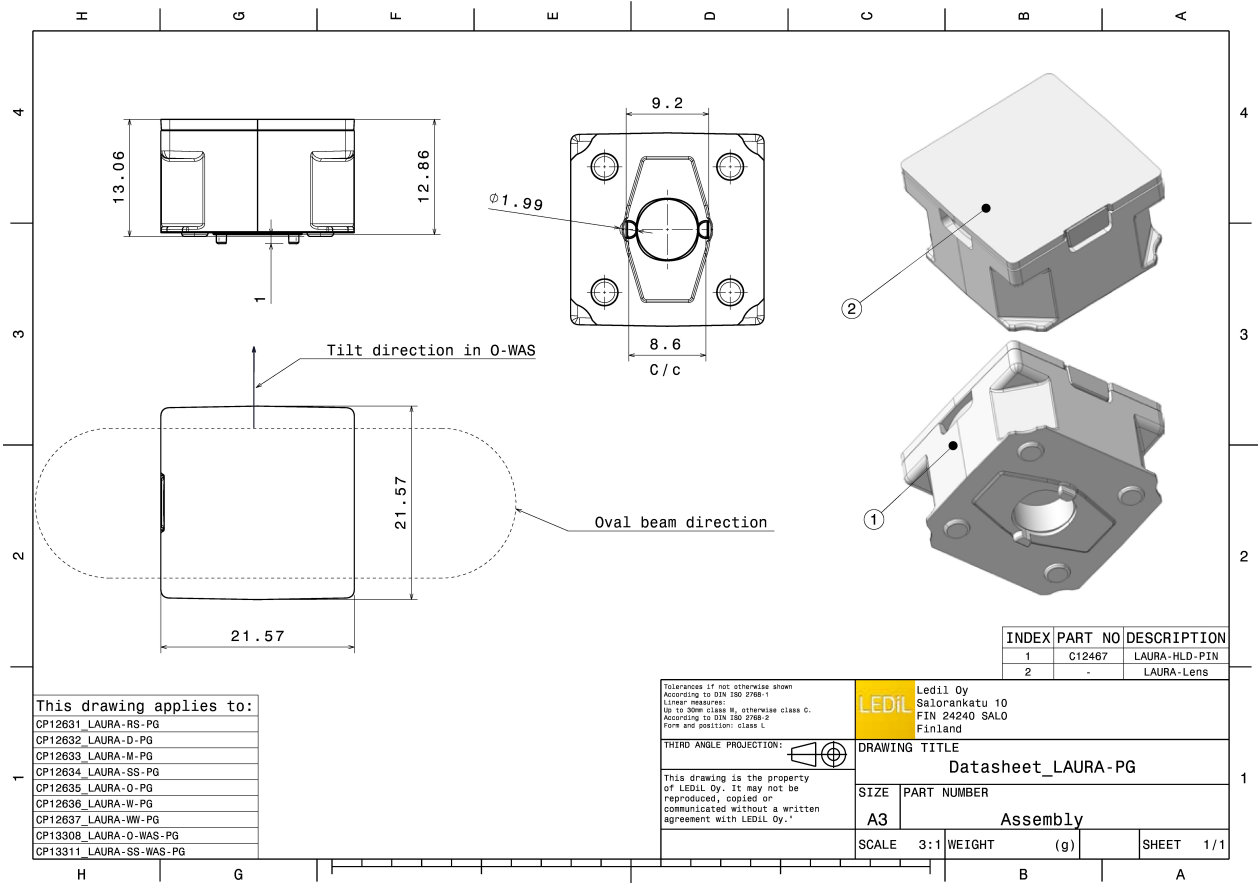

#### PHOTOMETRIC DATA (MEASURED):

#### CREE

LED XP-E-HEW  
 FWHM 15.0°  
 Efficiency 86 %  
 Peak intensity 6.200 cd/lm  
 LEDs/each optic 1  
 Light colour White  
 Required components:

#### CREE

LED XP-G  
 FWHM 16.0°  
 Efficiency 91 %  
 Peak intensity 6.800 cd/lm  
 LEDs/each optic 1  
 Light colour White  
 Required components:

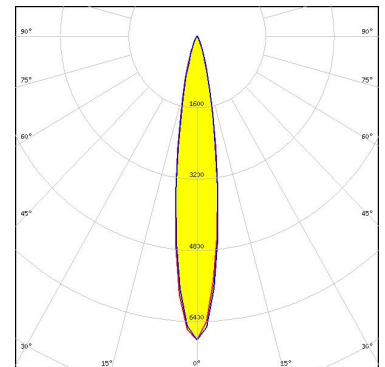
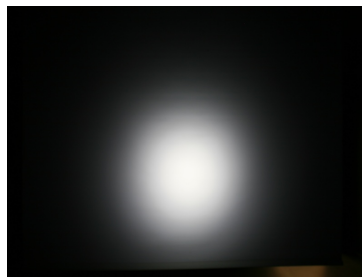

#### CREE

LED XT-E  
 FWHM 18.0°  
 Efficiency 90 %  
 Peak intensity 6.700 cd/lm  
 LEDs/each optic 1  
 Light colour White  
 Required components:

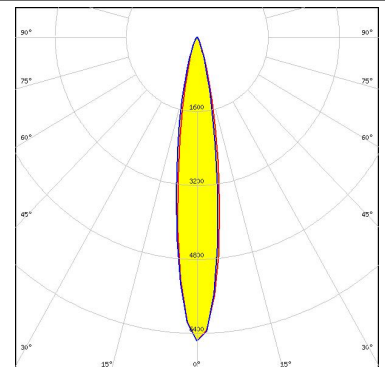
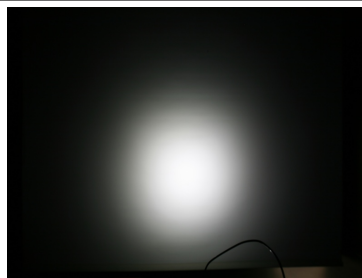

#### LUMILEDS

LED LUXEON A  
 FWHM 17.0°  
 Efficiency 93 %  
 Peak intensity 7.100 cd/lm  
 LEDs/each optic 1  
 Light colour White  
 Required components:

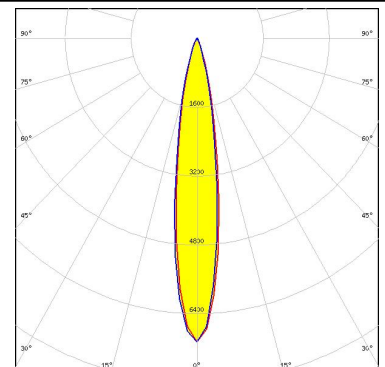

### PHOTOMETRIC DATA (MEASURED):



LED LUXEON Rebel  
FWHM 15.0°  
Efficiency 90 %  
Peak intensity 5.000 cd/lm  
LEDs/each optic 1  
Light colour White  
Required components:



LED NVSxx19A  
FWHM 19.0°  
Efficiency 90 %  
Peak intensity 6.000 cd/lm  
LEDs/each optic 1  
Light colour White  
Required components:

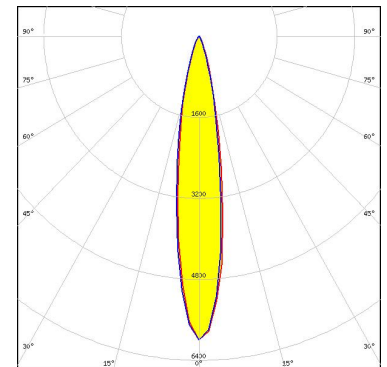
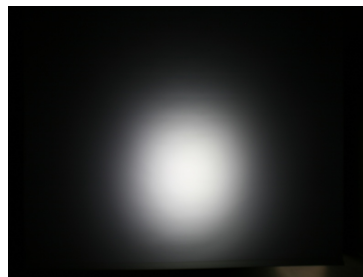

LED OSOLON Square EC  
FWHM 15.0°  
Efficiency 89 %  
Peak intensity 6.400 cd/lm  
LEDs/each optic 1  
Light colour White  
Required components:

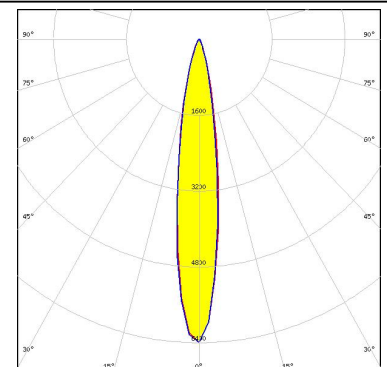

#### PHOTOMETRIC DATA (SIMULATED):



LED XP-E  
 FWHM 12.0°  
 Efficiency 96 %  
 Peak intensity 19.442 cd/lm  
 LEDs/each optic 1  
 Light colour White  
 Required components:

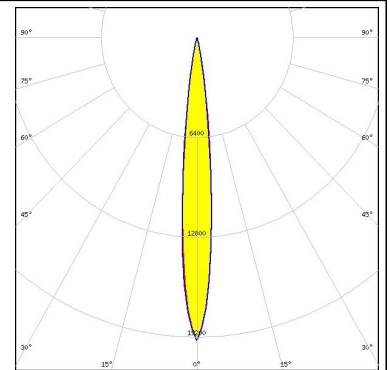

LED NCSxx19A  
 FWHM 12.0°  
 Efficiency 94 %  
 Peak intensity 19.038 cd/lm  
 LEDs/each optic 1  
 Light colour White  
 Required components:

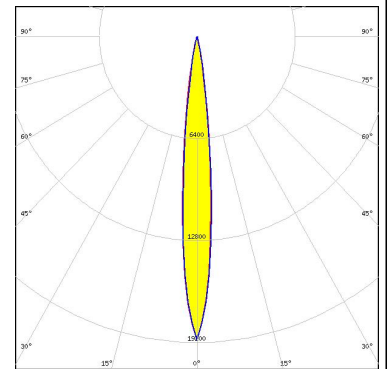

LED OSOLON SSL 150  
 FWHM 9.0°  
 Efficiency 95 %  
 Peak intensity 29.814 cd/lm  
 LEDs/each optic 1  
 Light colour White  
 Required components:

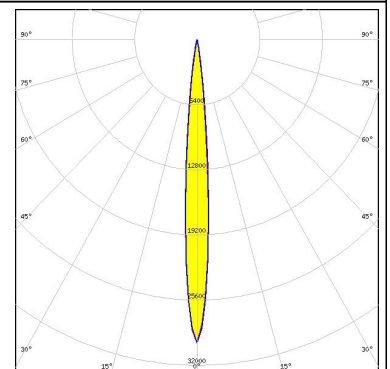

LED OSOLON SSL 80  
 FWHM 8.0°  
 Efficiency 95 %  
 Peak intensity 32.976 cd/lm  
 LEDs/each optic 1  
 Light colour White  
 Required components:

### GENERAL INFORMATION:

NOTE: The typical beam angle will be changed by different color, chip size and chip position tolerance. The typical total beam angle is the full angle measured where the luminous intensity is half of the peak value.

### MATERIALS:

As part of our continuous research and improvement processes, and to ensure the best possible quality and availability of our products, LEDiL reserves the right to change material grades without notice.

### PRODUCT DATA USER AGREEMENT AND DISCLAIMER:

The measured data in the provided downloadable LEDiL Product Datasheets and Mechanical 2D-Drawings is rounded and provided as reference for planning. LEDiL Oy's optical specifications have been verified by conducting performance testing of the products in accordance with the company's quality system. The reported data are averaged results of multiple measurements with typical variation. LEDiL Oy reserves the right to without prior notification make changes and improvements to its products.

LEDiL Oy assumes neither warranty, nor guarantee nor any other liability of any kind for the contents and correctness of the provided data. The provided data has been generated with highest diligence but the provided data may in reality not represent the complete possible variation range of all intrinsic parameters. Therefore, in certain cases a deviation from the provided data could occur.

LEDiL Oy reserves the right to undertake technical changes of its products without further notification which could lead to changes in the provided data. LEDiL Oy assumes no liability of any kind for the possible deviation from any provided data or any other damage resulting from the usage of the provided data.

The user agrees to this disclaimer and user agreement with the download or usage of the provided files.

#### LEDiL Oy

Joensuunkatu 13  
FI-24240 SALO  
Finland

#### LEDiL Inc.

228 West Page Street  
Suite D  
Sycamore IL 60178  
USA

#### Local sales and technical support

[www.ledil.com/  
where\\_to\\_buy](http://www.ledil.com/where_to_buy)

#### Shipping locations

Salo, Finland  
Hong Kong, China

#### Distribution Partners

[www.ledil.com/  
where\\_to\\_buy](http://www.ledil.com/where_to_buy)