

COUNT	DESCRIPTION OF REVISIONS	BY	CHKD	DATE	COUNT	DESCRIPTION OF REVISIONS	BY	CHKD	DATE
△					△				
△					△				
△					△				

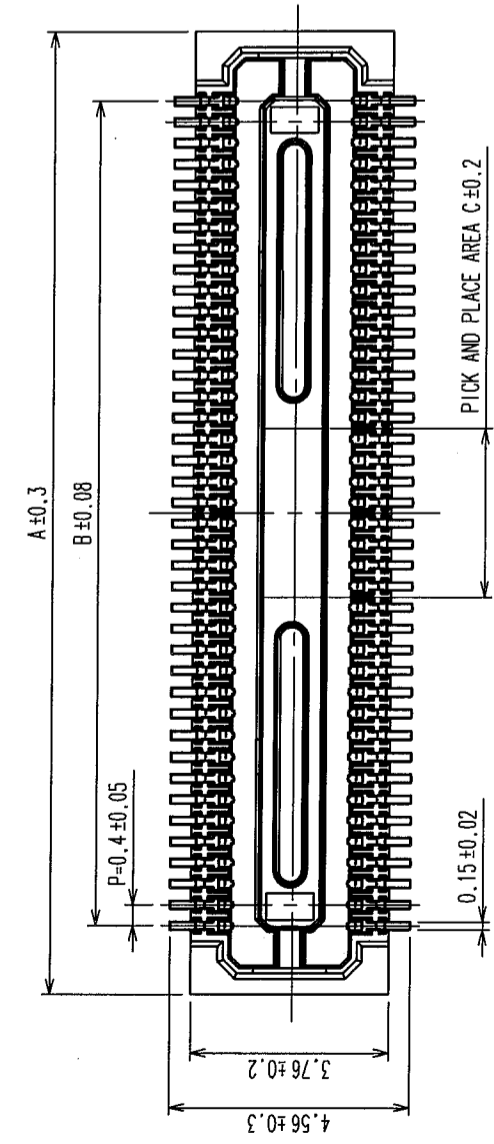

RECOMMEND PATTERN

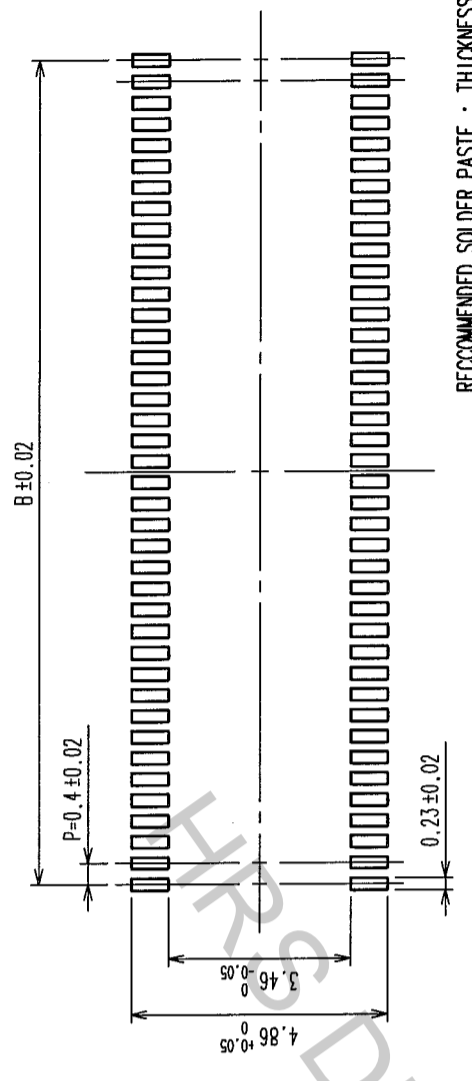

RECOMMENDED SOLDER PASTE : THICKNESS 120μm

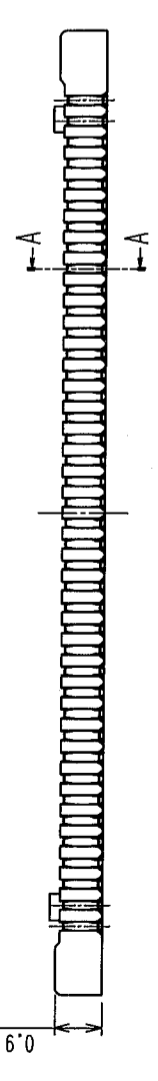
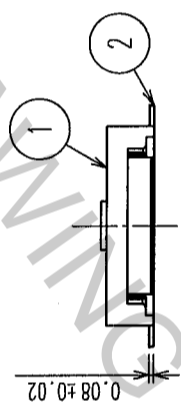

A-A(20:1)

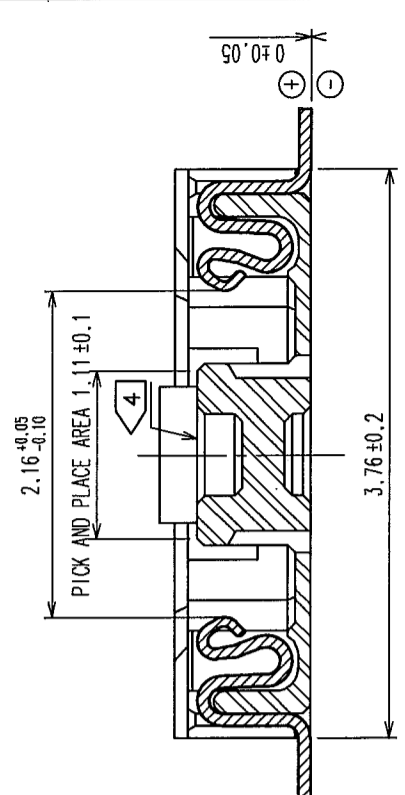

ENGAGEMENT FIGURE (20:1)

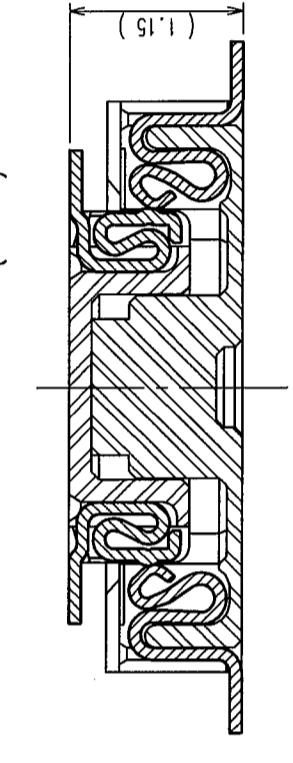

PART NO.	CODE NO.	A	B	C
DF30CJ-80DS-0.4V(82)	CL684-1158-3-82	18.22	15.6	3.2
DF30CJ-70DS-0.4V(82)	CL684-1163-3-82	16.22	13.6	2.8
DF30CJ-60DS-0.4V(82)	CL684-1162-0-82	14.22	11.6	2.4
DF30CJ-50DS-0.4V(82)	CL684-1161-8-82	12.22	9.6	2
DF30CJ-40DS-0.4V(82)	CL684-1084-9-82	10.22	7.6	1.6
DF30CJ-34DS-0.4V(82)	CL684-1164-6-82	9.02	6.4	1.36
DF30CJ-30DS-0.4V(82)	CL684-1160-5-82	8.22	5.6	1.2
DF30CJ-24DS-0.4V(82)	CL684-1086-4-82	7.02	4.4	1.2
DF30CJ-22DS-0.4V(82)	CL684-1159-6-82	6.62	4.0	1.2
DF30CJ-20DS-0.4V(82)	CL684-1085-1-82	6.22	3.6	1.2

NO.	MATERIAL	FINISH, REMARKS	NO.	MATERIAL	FINISH, REMARKS
2	PHOSPHOR BRONZE		5	PS	BLACK(PLASTIC REEL)
1	LCP	UL94V-0, BLACK	4	POLYESTER	CLEAR(COVER TAPE)
			3	PS	CLEAR(EMBOSSED CARRIER TAPE)

CODE NO. (OLD)	DRAWN	DESIGNED	CHECKED	APPROVED	RELEASED
	F. Matsuki	A. Takahashi	T. Miyagaki	J. Oma	
	'05.03.08	'05.03.09	'05.03.09	'05.03.09	

DRAWING NO.	PART NO.
EDC3-304208-01	DF30CJ-*DS-0.4V(82)

SCALE	UNITS	CODE NO.
FREE	MM	CL684-***-**-82

NOTE 1. ALL LEADS CO-PLANARITY SHALL BE 0.1 MAX.  
 2. PER REEL : 1000 CONNECTORS.  
 3. AT THE BEGINNING OF THE REEL, 100 mm AT MIN SHALL BE EMPTY POCKETS.

AT THE END OF THE REEL, 160 mm AT MIN SHALL BE EMPTY POCKETS.  
 4. NO CAVITY ON THE CONNECTORS LESS THAN 24 POS.  
 5. CONTACT PLATING SPECIFICATIONS.

CONTACT AREA : GOLD 0.05μm MIN.  
 SMT LEAD : GOLD 0.02μm MIN.  
 UNDERPLATING : NICKEL 1μm MIN.  
 (SURFACE : SEALING)

TO	
----	--

COUNT	DESCRIPTION OF REVISIONS	BY	CHKD	DATE	COUNT	DESCRIPTION OF REVISIONS	BY	CHKD	DATE

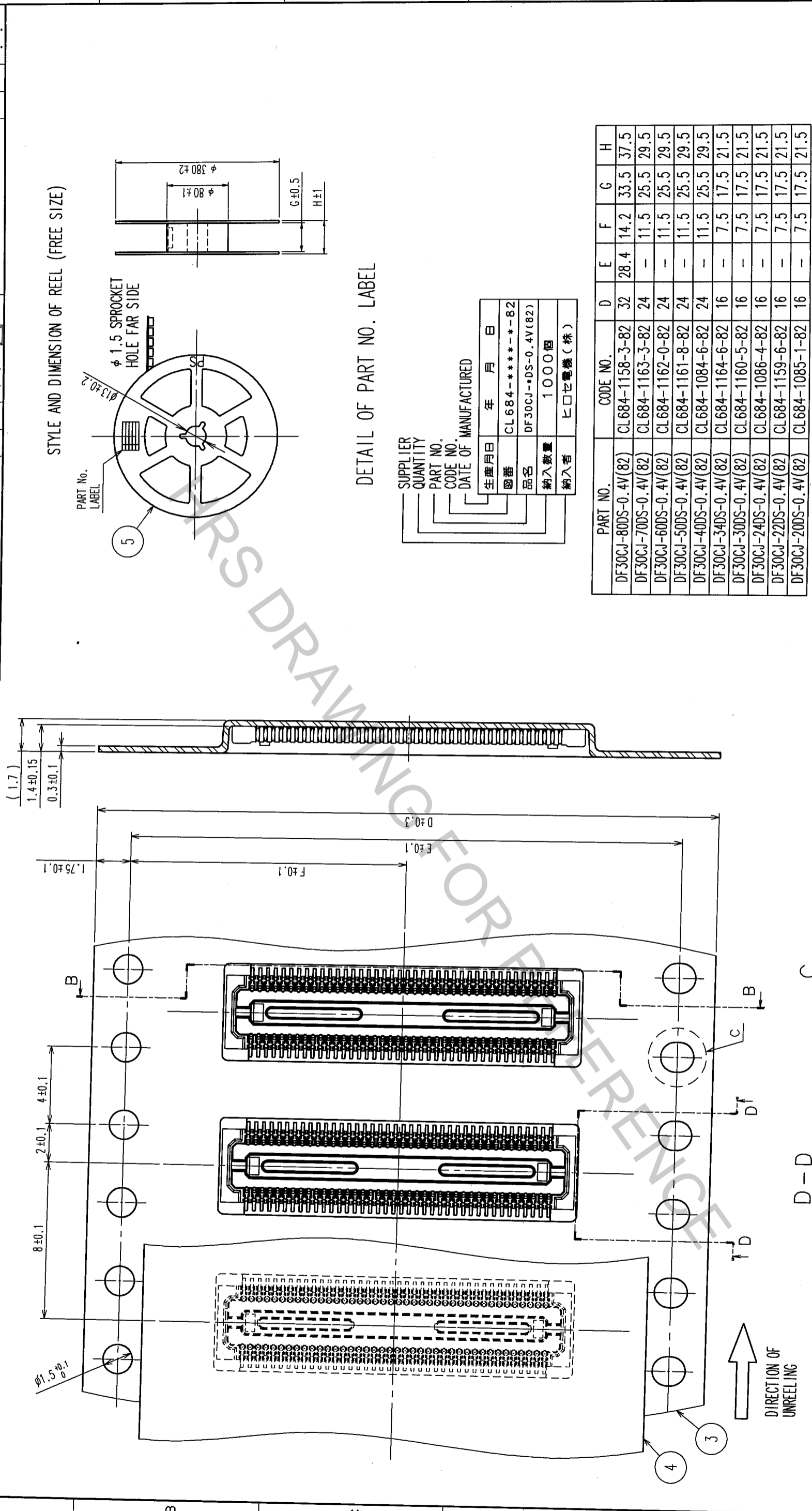

CODE NO. (OLD)	DRAWN	DESIGNED	CHECKED	APPROVED	RELEASED
	F. Matsuki	A. Takahashi	T. Miyagaki	J. Ota	
	'05.03.08	'05.03.08	'05.03.09	'05.03.09	

DRAWING NO.	EDC3-304208-01	PART NO.	DF30CJ-DS-0.4V(82)
SCALE	5 : 1	CODE NO.	CL684-1158-3-82
UNITS	mm		

