

# PRODUCT TERMINATION NOTIFICATION

PTN No:	PTN-SM2109
Announcement date	2021-09-17
Last date for placing order	2022-03-31
Product Termination Date (LAST SHIPMENT)	2022-09-30

1. Product(s):

MB85R256FPNF-G-JNE2 (SOP28)  
 MB85R256FPNF-G-JNERE2 (SOP28)

2. Reason of Phasing Out:

The materials manufacturers have notified our subcontractor that they would terminate the Lead flame and Mold resin for SOP28 until end of March 2022. Then since the SOP 28 production line at the subcontractor is aging and the equipment has already reached the end of its life, and the subcontractor to decision they wouldn't to rebuild the production line.

In response to this, we had been examined the possibility of continuing production by changing the manufacturing subcontractor of SOP28. But we did not have a new contractor that could handle the small volume production.

As a result, it has become difficult to continue manufacturing, so we would stop supplying the product.

Thank you for your corporation.

You are kindly requested to give us a feedback about this phasing out, telling us if you will place a last time order (please see above last date for placing orders).

**Without any feedback from you within 6 months according to J-STD-048, we will assume that you don't need last time buy.**

Here below you can find the right information to contact us for any further information you need:

Contact details for any further information:

Originator:

Name: FUJITSU Semiconductor Memry  
Solution Limited.  
Quality Assurance Dept.  
YAMAZAKI

Address: Shin-Yokohama TECH Building  
3-9-1 Shin-Yokohama, Kohoku-  
Ku, Yokohama, Kanagawa,  
222-0033, Japan

Phone/Fax: +81-45-473-9067

E-mail: hiro.yamazaki@fujitsu.com

Sales Dir. / Manager:

Name: FUJITSU Semiconductor Memory  
Solution Limited.  
Sales Department II.  
Director NOZU

Phone/Fax: +81-45-755-7045

E-mail: nozu.yusuke@fujitsu.com

Quality Department:

Name: FUJITSU Semiconductor Memory  
Solution Limited.  
Quality Assurance Dept.  
Director INOUE

Phone/Fax: +81-45-473-9067

E-mail: ken-ichi.inoue@jp.fujitsu.com

# EOL of SOP28 package product

Fujitsu Semiconductor Memory Solution Ltd.  
September 17<sup>th</sup>, 2021

PTN-SM2109

# 1. Background to the termination of supply

The material manufacturer has decided to terminate components of SOP28 packages, lead frames and mold resins, by March 2022.

In addition, the back-end contractor's production line for SOP28 has been aging and has already reached the end of its service life, so they decided to EOL the production line.

In response to the above notice, we have been considering the possibility of changing the manufacturing contractor for continued production, but there is no new contractor that can handle the production of SOP28 with small quantities. Therefore, we will terminate the supply of this product due to the difficulty of continuous manufacturing.

We apologize for any inconvenience this may cause, and thank you for your understanding.

# 2. Affected part number

## MB85R256FPNF-G-JNE2 MB85R256FPNF-G-JNERE2

### PKG:SOP28

	リードピッチ	1.27mm
	パッケージ幅× パッケージ長さ	7.6 × 17.75mm
	リード形状	ガルウイング
	封止方法	プラスチックモールド
	取付け高さ	2.80mm MAX

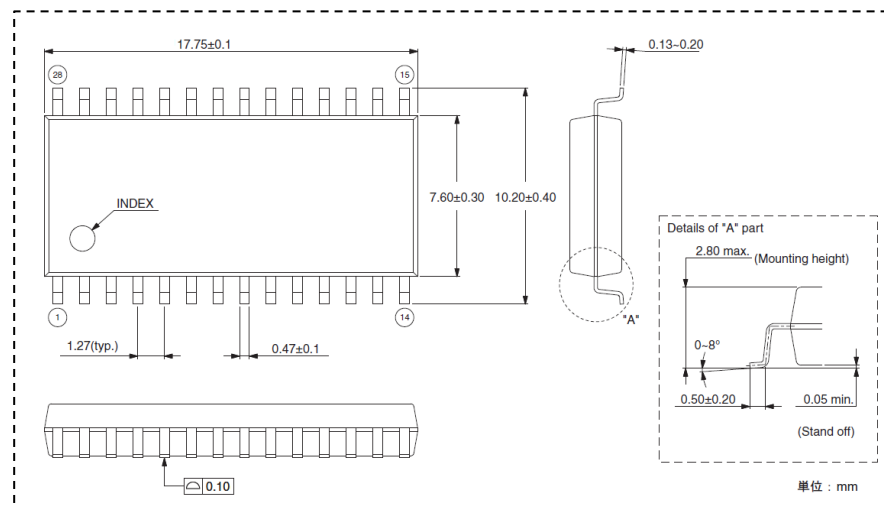



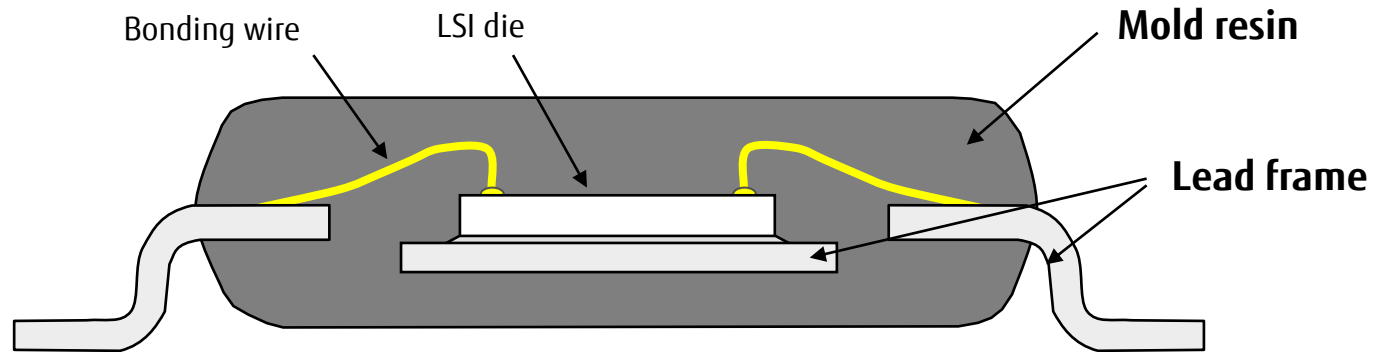

### 3. Package structure and discontinued parts materials

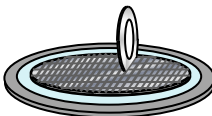
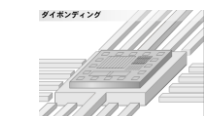
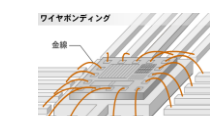

Lead frames and mold resins are the main materials for packaging components, which will no longer be procurable in March 2022 due to the end of material production at component manufacturers.

There is no proposal for alternative materials from the manufacturer due to the discontinuation of material production, and in order to continue package manufacturing, new packaging technology development including material development will be required, making it highly difficult for contract manufacturing companies.

# 4. Overview of the current production line and measures for aging

Packaging process	Manufacturing equipment / mold, tool	Current line status	Measures for aging
 <p>Chip dicing</p>	General-purpose equipment / general-purpose tool	Replaced as needed when new equipment is installed	Supported
 <p>Chip mounting</p>	General-purpose equipment / general-purpose tool	Replaced as needed when new equipment is installed	Supported
 <p>Wire bonding</p>	General-purpose equipment / general-purpose tool	Replaced as needed when new equipment is installed	Supported
 <p>Resin molding</p>	Specialized equipment / specialized mold	Continued use of equipment at line start-up	Equipment and mold required
 <p>Lead shaping</p>	Specialized equipment / specialized shaping mold	Continued use of equipment at line start-up	Equipment and mold required
 <p>Inspection and testing</p>	General-purpose equipment / specialized tool	Replaced as needed when new equipment is installed	Supported

❌ The following equipment is required to implement measures for aging production lines.

- New mold equipment and fabrication of mold for SOP28.
- New lead shaping equipment and fabrication of lead shaping mold for SOP28.

# 5. Conclusion

- Consideration of continued production using the current production line

While packaging technology development, including material development, and preparation of new manufacturing facilities are required, the demand for SOP28 is declining year by year.

In the end, we had to put this product into EOL.

- Consideration of continued production by changing the contract manufacturer

There are no new contractors that could handle the small volume SOP28 production.

As a result, it has become difficult to continue manufacturing the product, and we are discontinuing the product supply.



# 6. Schedule

	2021				2022								
	Sep.	Oct.	Nov.	Dec.	Jan.	Feb.	Mar.	Apr.			Jul.	Aug.	Sep.
EOL notification	▼												
Last time buy							▼						
Last time production								▶					
Last time shipment													▼

Last time buy : by March 31<sup>st</sup> , 2022

Last time shipment : by September 30<sup>th</sup> , 2022

# 7. Request

Thank you very much for using our products for a long period of time.

We regret to inform you that we will no longer be able to supply SOP28 due to the difficulty of its continuous production.

We apologize for the inconvenience and appreciate your understanding.

In addition, due to the rapid increase in demand in the current semiconductor market, delivery times for lead frames, mold resin, and other materials have become longer and longer, and procurement has become more difficult.

Therefore, we would appreciate your cooperation in placing the last time order as early as possible.



**FUJITSU**

shaping tomorrow with you