



DO NOT REVISE EXCEPT BY CAD

LOC  
AP

DIST  
—

REVISIONS

P	LTR	DESCRIPTION	DATE	DWN	APVD
C		REDRAWN BY ECO-11-009754	22JUN2011	MAS	MG

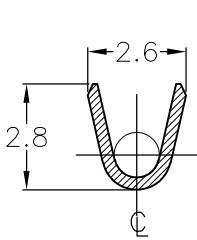
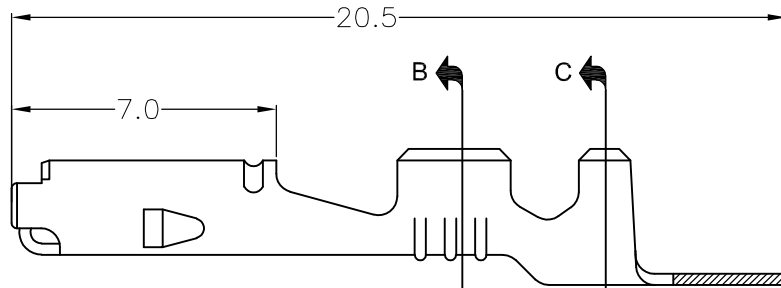
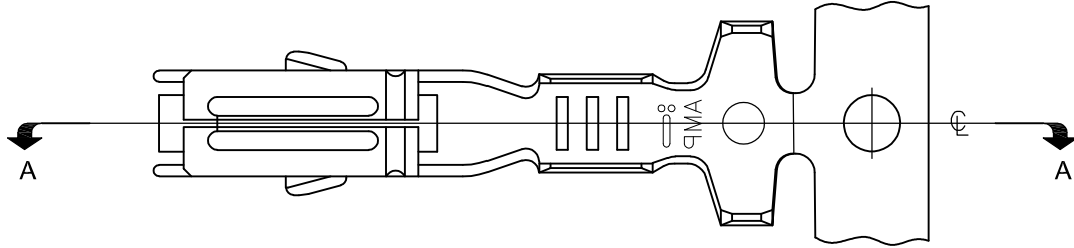
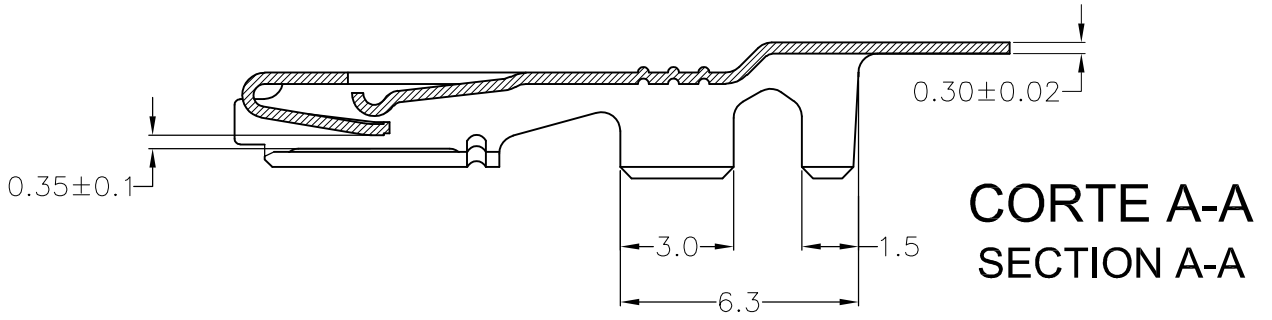

**CORTE B-B**  
**SECTION B-B**

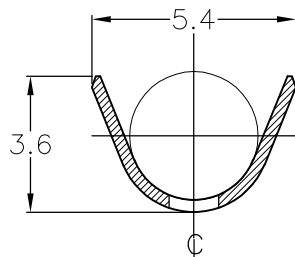

**CORTE C-C**  
**SECTION C-C**

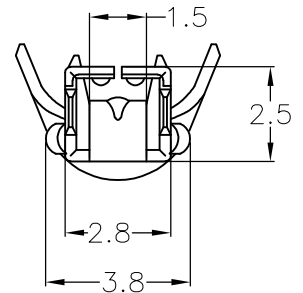

WIRE RANGE 0,5-1,0mm <sup>2</sup>	PRÉ-PRATEADO PRE-SILVER	LATÃO BRASS	880697-3
	PRÉ-ESTANHADO PRE TIN	BRONZE FOSFOROSO PHOS. BRONZE	880697-2
ISUL. RANGE DIA. 1,4-2,4	PRÉ-ESTANHADO PRE TIN	LATÃO BRASS	880697-1
	<b>FINISH</b>	<b>MATERIAL</b>	<b>PART NUMBER</b>

DIMENSIONS:  
mm

DWN H.LIVERARO 25JAN01

MATERIAL VER TABELA/SEE TABLE

FINISH VER TABELA/SEE TABLE

TOLERANCES UNLESS OTHERWISE SPECIFIED:

CHK N.C.LAPRESA 25JAN01

APVD L.G.DALTO 25JAN01



TE Connectivity

0 PLC	± -
1 PLC	± 0.3
2 PLC	± -
3 PLC	± 3
4 PLC	± -
ANGLES	±

PRODUCT SPEC

—

APPLICATION SPEC

—

WEIGHT

—

NAME  
TERMINAL, 1.8 ECONOSEAL  
"J" SERIES MARK II+ REC.

SIZE	CAGE CODE	DRAWING NO	RESTRICTED TO
A4	00779	C-880697	—

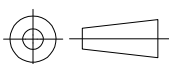

CUSTOMER DRAWING

SCALE 1:1 SHEET 1 OF 1 REV C

RELEASED FOR PUBLICATION

ALL RIGHTS RESERVED.

THIS DRAWING IS UNPUBLISHED.

By -  
COPYRIGHT -