

1A, 200V Ultra Fast Surface Mount Rectifier

FEATURES

- AEC-Q101 qualified
- Glass passivated chip junction
- Ideal for automated placement
- Low profile package
- Ultra Fast recovery time for high efficiency
- Moisture sensitivity level: level 1, per J-STD-020
- RoHS Compliant
- Halogen-free according to IEC 61249-2-21

APPLICATIONS

- High frequency rectification
- Freewheeling application
- Switching mode converters and inverters in automotive

MECHANICAL DATA

- Case: SOD-128
- Molding compound meets UL 94V-0 flammability rating
- Terminal: Mattle tin plated leads, solderable per J-STD-002
- Meet JESD 201 class 2 whisker test
- Polarity: Indicated by cathode band
- Weight: 0.027 g (approximately)

KEY PARAMETERS		
PARAMETER	VALUE	UNIT
I_F	1	A
V_{RRM}	200	V
I_{FSM}	60	A
$T_{J\ MAX}$	175	°C
Package	SOD-128	
Configuration	Single die	



SOD-128



ABSOLUTE MAXIMUM RATINGS ($T_A = 25^\circ\text{C}$ unless otherwise noted)			
PARAMETER	SYMBOL	ESH1DFSH	UNIT
Marking code on the device		H1DFSH	
Repetitive peak reverse voltage	V_{RRM}	200	V
Reverse voltage, total rms value	$V_{R(RMS)}$	140	V
Forward current	I_F	1	A
Surge peak forward current single half sine-wave superimposed on rated load	$t = 8.3\text{ms}$	60	A
	$t = 1.0\text{ms}$	80	A
Junction temperature	T_J	- 55 to +175	°C
Storage temperature	T_{STG}	- 55 to +175	°C

THERMAL PERFORMANCE			
PARAMETER	SYMBOL	TYP	UNIT
Junction-to-lead thermal resistance	$R_{\theta JL}$	18	°C/W
Junction-to-ambient thermal resistance	$R_{\theta JA}$	72	°C/W
Junction-to-case thermal resistance	$R_{\theta JC}$	14	°C/W

Thermal Performance Note: Units mounted on PCB (5mm x 5mm Cu pad test board)

ELECTRICAL SPECIFICATIONS ($T_A = 25^\circ\text{C}$ unless otherwise noted)					
PARAMETER	CONDITIONS	SYMBOL	TYP	MAX	UNIT
Forward voltage ⁽¹⁾	$I_F = 0.5\text{A}, T_J = 25^\circ\text{C}$	V_F	0.80	-	V
	$I_F = 1.0\text{A}, T_J = 25^\circ\text{C}$		0.84	0.94	V
	$I_F = 0.5\text{A}, T_J = 125^\circ\text{C}$		0.64	-	V
	$I_F = 1.0\text{A}, T_J = 125^\circ\text{C}$		0.71	0.81	V
Reverse current @ rated V_R ⁽²⁾	$T_J = 25^\circ\text{C}$	I_R	-	5	μA
	$T_J = 125^\circ\text{C}$		-	27	μA
Junction capacitance	1MHz, $V_R = 4.0\text{V}$	C_J	15	-	pF
Reverse recovery time	$I_F = 0.5\text{A}, I_R = 1.0\text{A}$ $I_{rr} = 0.25\text{A}$	t_{rr}	-	25	ns

Notes:

1. Pulse test with PW = 0.3ms
2. Pulse test with PW = 30ms

ORDERING INFORMATION		
ORDERING CODE	PACKAGE	PACKING
ESH1DFSH	SOD-128	14,000 / Tape & Reel

CHARACTERISTICS CURVES

($T_A = 25^\circ\text{C}$ unless otherwise noted)

Fig.1 Forward Current Derating Curve

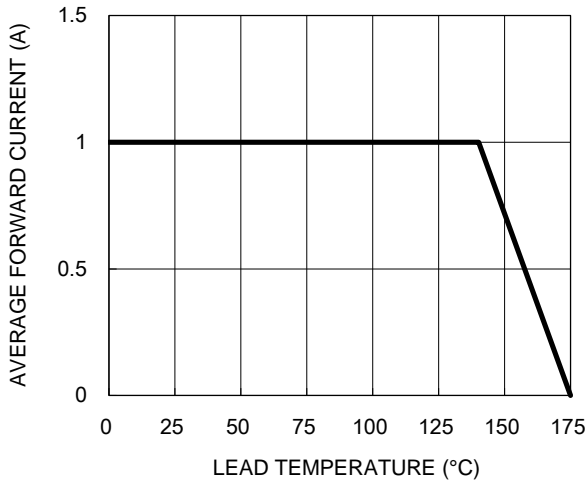

Fig.2 Typical Junction Capacitance

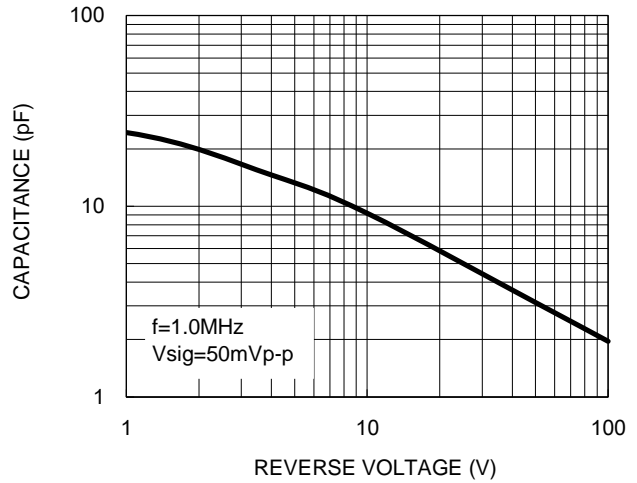

Fig.3 Typical Reverse Characteristics

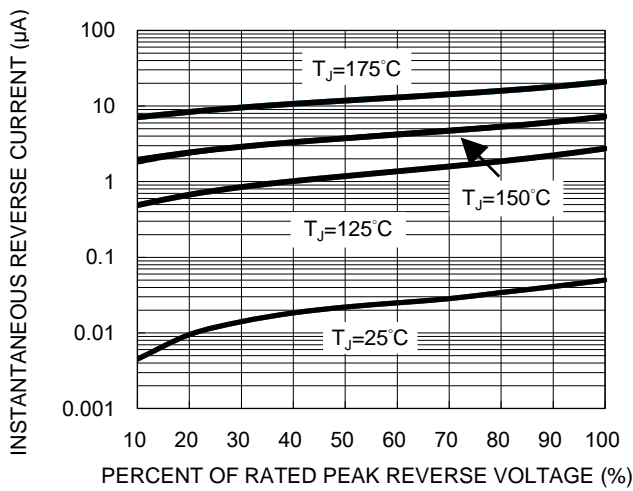

Fig.4 Typical Forward Characteristics

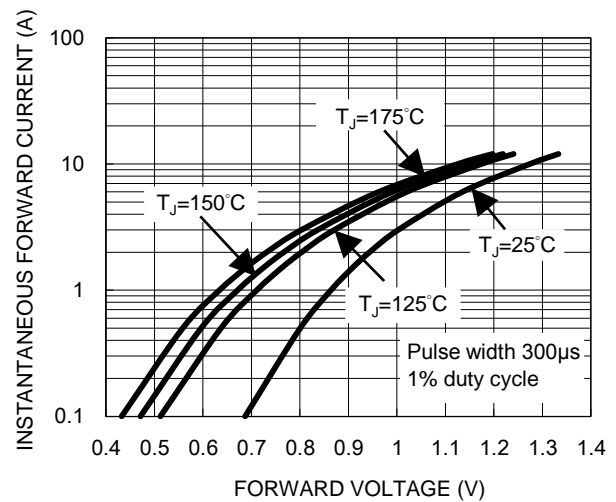
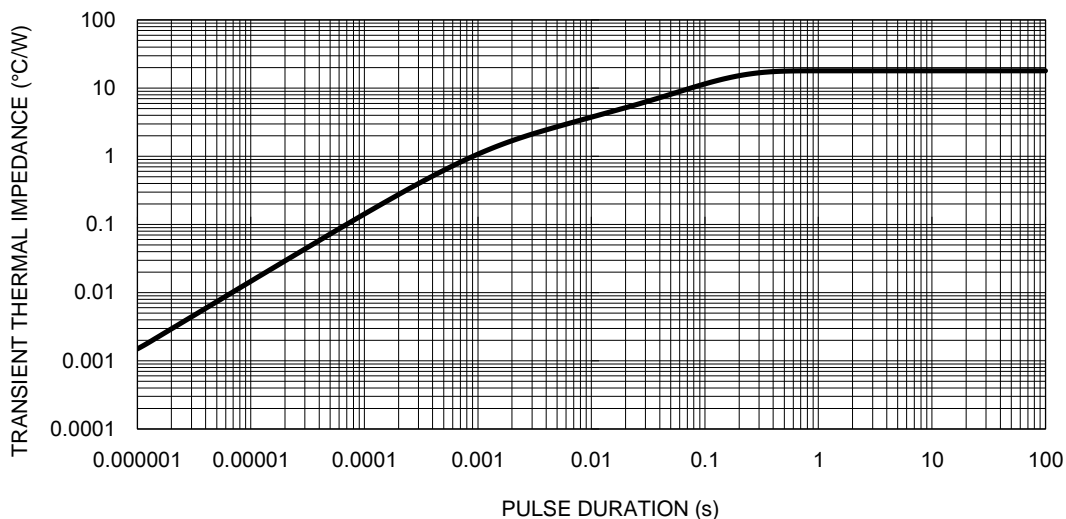
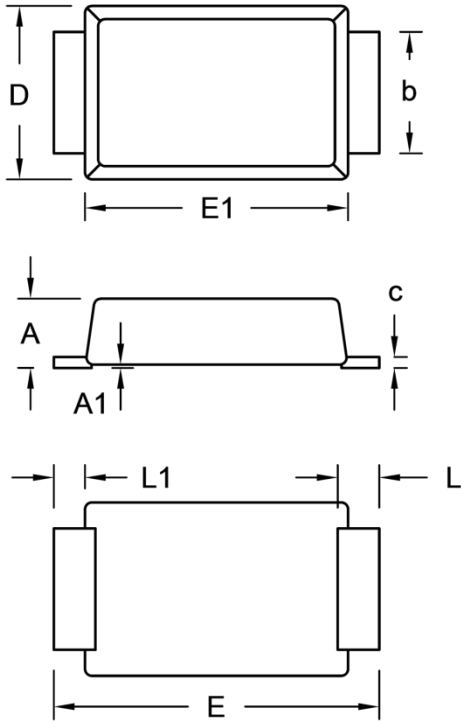

Fig.5 Typical Transient Thermal Impedance



PACKAGE OUTLINE DIMENSIONS

SOD-128



DIM.	Unit (mm)		Unit (inch)	
	Min.	Max.	Min.	Max.
A	0.90	1.10	0.035	0.043
A1	0.00	0.10	0.000	0.004
b	1.60	1.90	0.063	0.075
c	0.10	0.22	0.004	0.009
D	2.30	2.70	0.091	0.106
E	4.40	5.00	0.173	0.197
E1	3.60	4.00	0.142	0.157
L	0.40	0.80	0.016	0.031
L1	0.30	0.60	0.012	0.024

SUGGESTED PAD LAYOUT

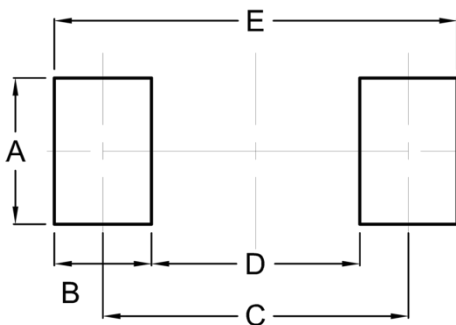

Symbol	Unit (mm)	Unit (inch)
A	2.10	0.083
B	1.40	0.055
C	4.40	0.173
D	3.00	0.118
E	5.80	0.228

MARKING DIAGRAM



P/N = Marking Code
 YW = Date Code
 F = Factory Code

Notice

Specifications of the products displayed herein are subject to change without notice. TSC or anyone on its behalf, assumes no responsibility or liability for any errors or inaccuracies.

Purchasers are solely responsible for the choice, selection, and use of TSC products and TSC assumes no liability for application assistance or the design of Purchasers' products.

Information contained herein is intended to provide a product description only. No license, express or implied, to any intellectual property rights is granted by this document. Except as provided in TSC's terms and conditions of sale for such products, TSC assumes no liability whatsoever, and disclaims any express or implied warranty, relating to sale and/or use of TSC products including liability or warranties relating to fitness for a particular purpose, merchantability, or infringement of any patent, copyright, or other intellectual property right.

The products shown herein are not designed for use in medical, life-saving, or life-sustaining applications. Customers using or selling these products for use in such applications do so at their own risk and agree to fully indemnify TSC for any damages resulting from such improper use or sale.