

HK-R-SR2-S RF Report

HIROSE ELECTRIC CO.,LTD.
Nov. 2019
Rev.0
RF-19007

Outline

- 1. Feature*
- 2. Simulation model*
- 3. Electrical performance*
- 4. Measurement data*

1. Feature

- Complies with MIL-STD-348B Standard
- Supports up to 40GHz frequency
- Screw mounting
 - Provides excellent high frequency performance and consistent assembly quality
 - Reusable
 - Reduces mounting complexity
- Flexible PCB thickness
- RoHS compliant

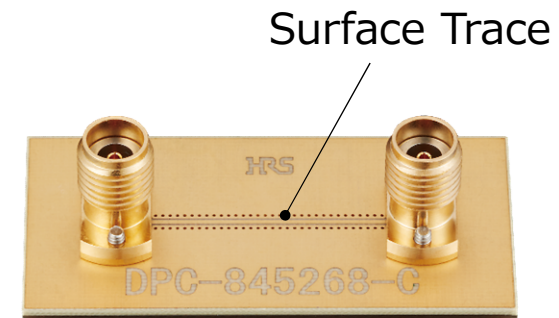
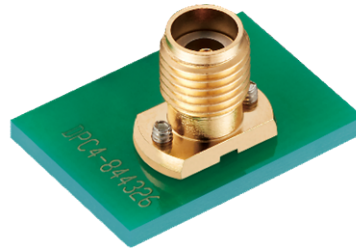

2. Simulation model

s2p file is created by HFSS.



Original model

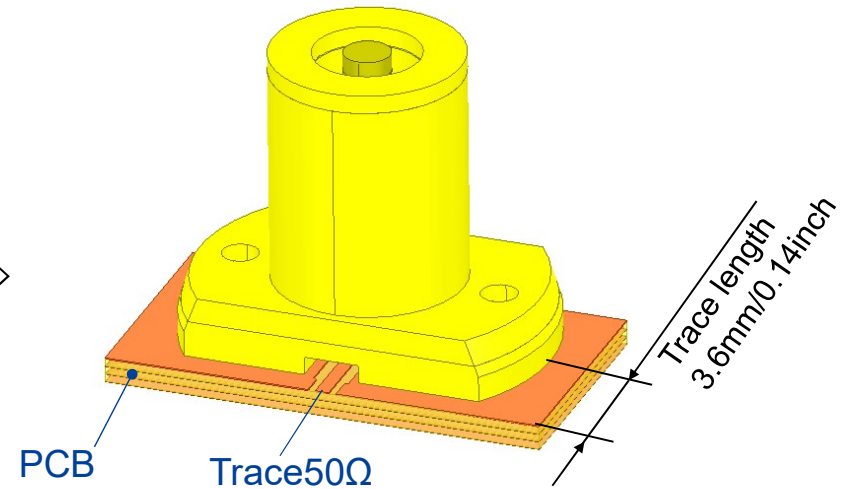
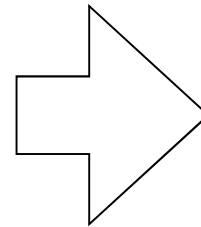

HFSS simulation model

Please see the details below:

<https://www.hirose.com/product/en/pr/mmwave/>

Simulation Model PCB layer		
Top	35 micron (Copper foil + Plating)	(1.0mm/0.04in)
	200 micron (Core Meg6 R-5775K $\epsilon_r=3.62$)	
L2	18 micron (Copper foil)	
	200 micron (PP Meg6 R-5670KG $\epsilon_r=3.62$)	
L3	18 micron (Copper foil)	
	200 micron (Core Meg6 R-5775K $\epsilon_r=3.62$)	
L4	35 micron (Copper foil+ Plating)	

3. Electrical performance

< VSWR >
VSWR(S11)

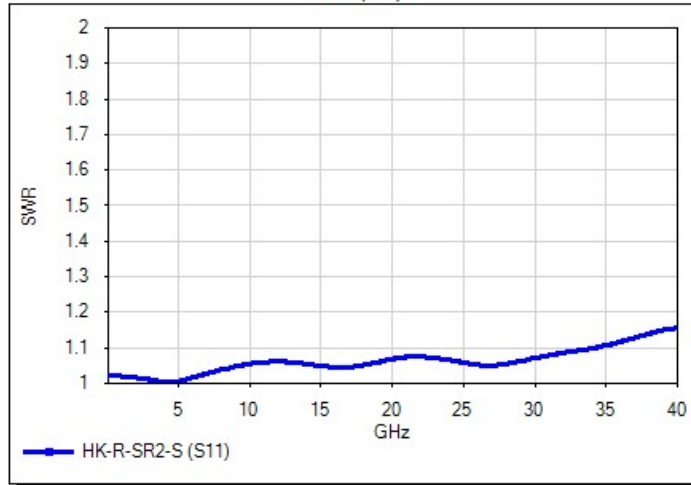

Simulation result: s2p

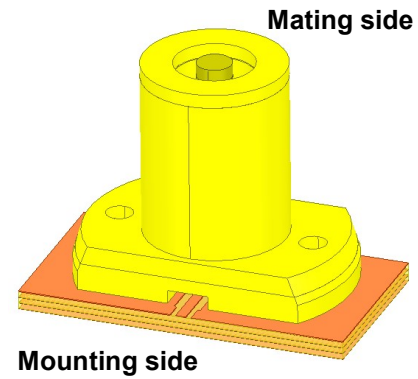

< Insertion Loss >
S21

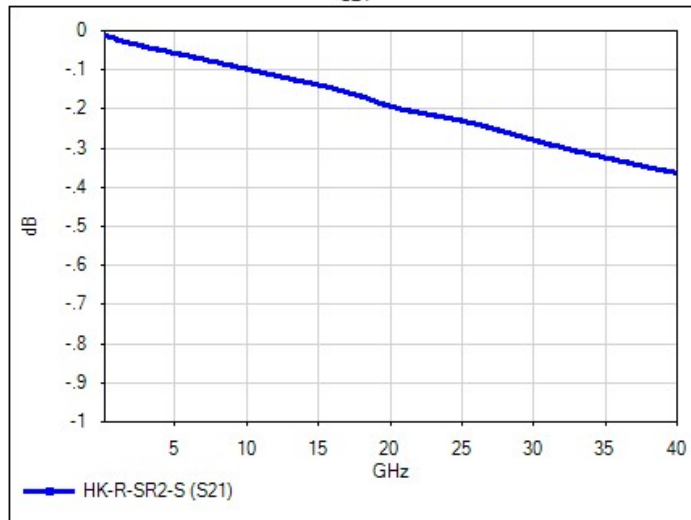

< TDR >

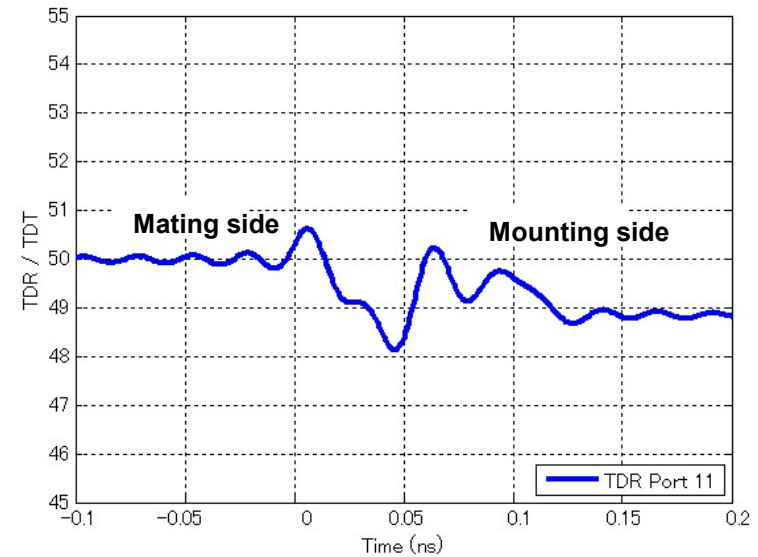

4.Measurement data

◆ Measurement setup

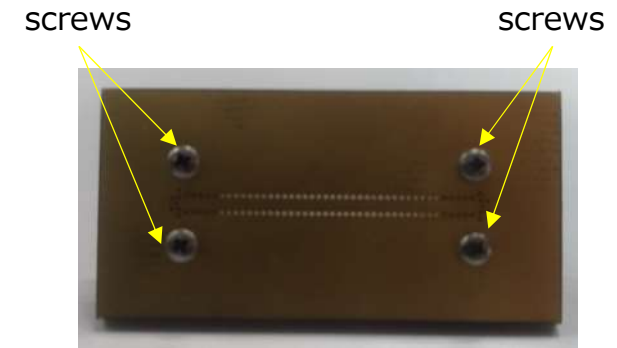
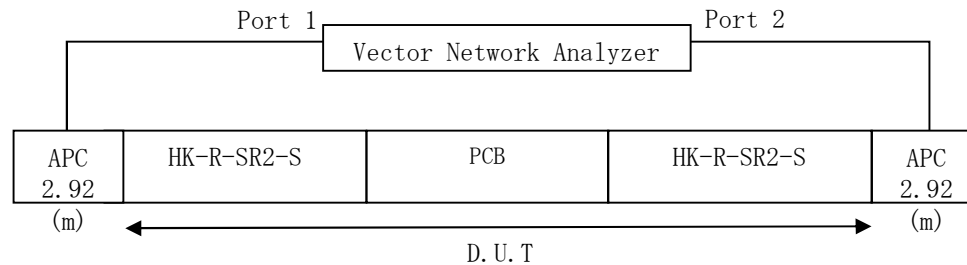

Back side of PCB

VNA information

2 port Agilent E8361A PNA

Frequency range : 100MHz – 40GHz

Number of Points : 801 points

IF band : 300Hz

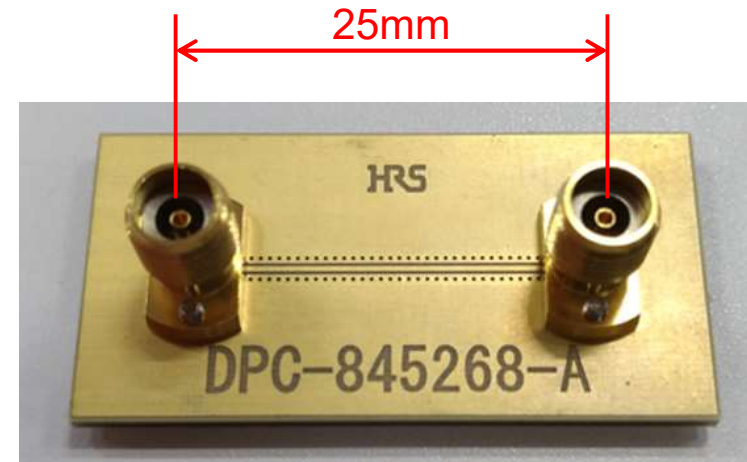

※ Please contact us for detail PCB design.
We can provide PCB design notes and HFSS encrypted model.

Measurement results



Measurement Results

< VSWR >

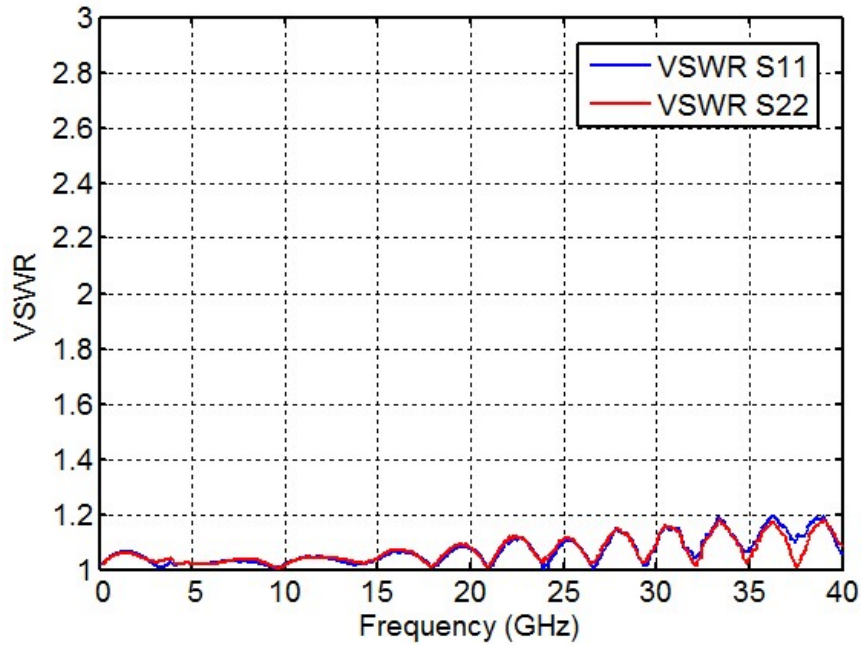

<Insertion Loss>

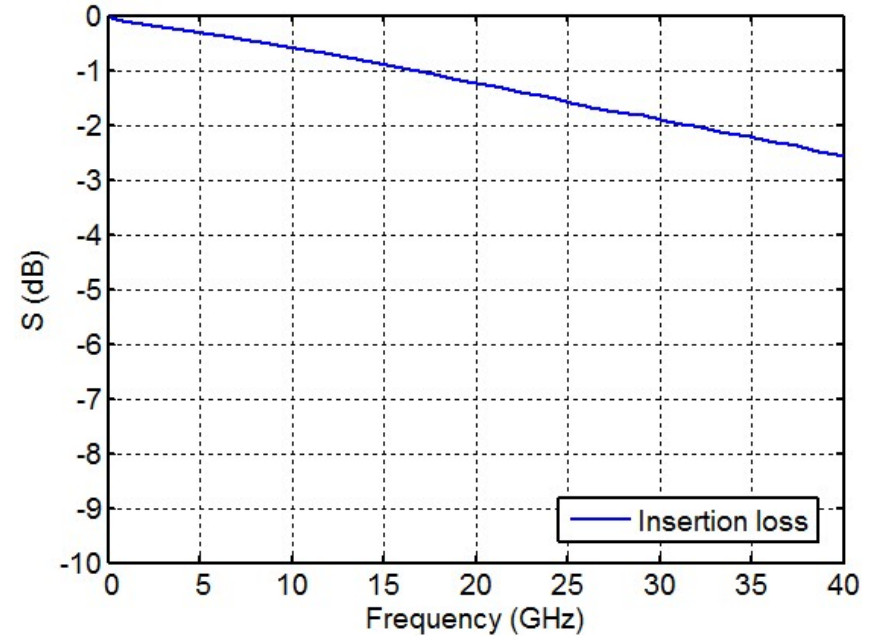

Comparisons

Hirose 2.92mm
HK-R-SR2-S



Measurement results

< VSWR >

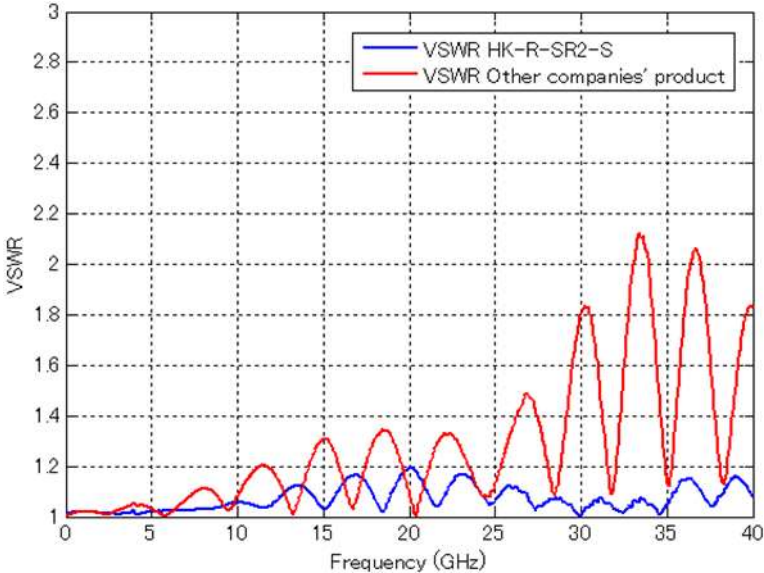

< Insertion Loss >

