

AMT10-V SERIES

Step by step instructions for the AMT10-V series

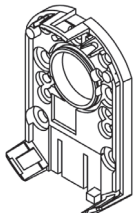

Top Cover



Base

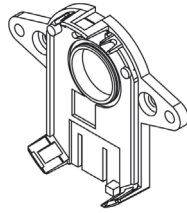

Wide Base
(with AMT102-V only)

- Sleeve Sizes:**
 2 mm = **Light Blue**
 3 mm = **Orange**
 3.175 mm (1/8") = **Purple**
 4 mm = **Gray**
 4.76 mm (3/16") = **Yellow**
 5 mm = **Green**
 6 mm = **Red**
 6.35 mm (1/4") = **White**
 8 mm = **Blue**



Sleeve

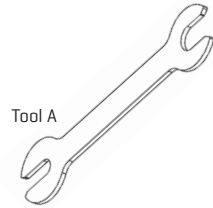

Tool A

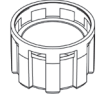

Shaft Adaptor

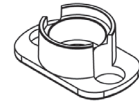

Tool B

AMT kits come with all items shown.

STEP 1

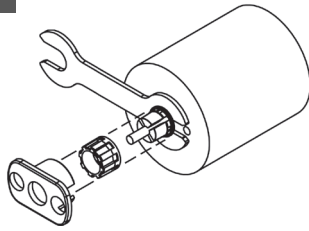

1. Insert Tool A as a spacer that defines the distance to the mounting surface.
2. Slide appropriate sized Sleeve over shaft all the way down to Tool A.
3. Slide Shaft Adaptor over Sleeve.
4. Use Tool B to press Shaft Adaptor over Sleeve until flush with Tool A.

STEP 2

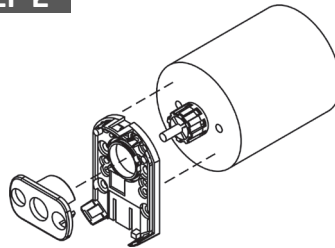

1. Remove Tools A and B.
2. Place Base on motor, with Tool B used as a centering tool.

STEP 3

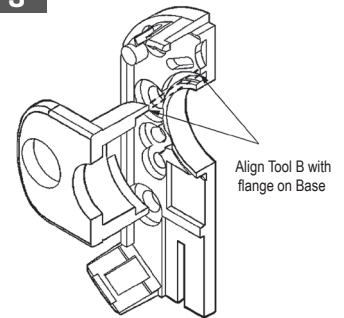

1. Align Tool B with flange on Base.
2. Slide Base and Tool B onto motor, centering onto the Shaft Adapter.

STEP 4

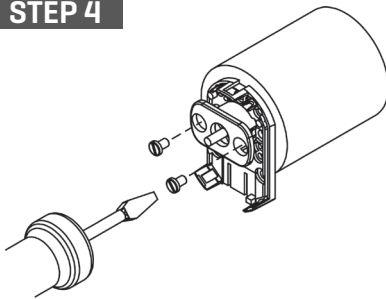

1. Fasten the Base on the motor.
2. Remove Tool B.

STEP 5

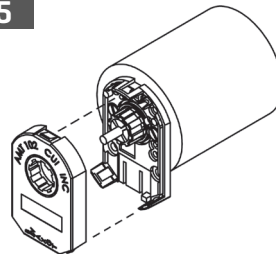

1. Slide the Top Cover onto the Base, carefully observing that the teeth of the Shaft Adaptor align with the grooves in the hub.*
- * We recommend no more than three cycles of mounting and removal of the AMT top cover base. Multiple cycles of mounting and removing the top cover can cause base fatigue over time and affect encoder performance.

STEP 6

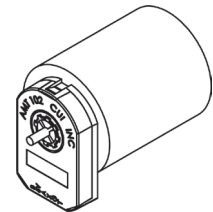

1. Make sure the snaps are fully engaged and the Top Cover is flush with the Base.
2. When assembly is finished, the Shaft Adaptor should be about flush with the front of the Encoder and the Motor Shaft should rotate freely.

For additional instructions or information contact customer support at CUI Inc: 800.275.4899

For more information visit www.cui.com

CUI Inc's products are not intended for applications where a failure could result in costly, dangerous, or life threatening situations. CUI Inc will not be responsible for damages, or losses greater than the cost of the CUI Inc replacement parts.



CUI Inc 20050 SW 112th Ave.
Tualatin, OR 97062

© 2014 CUI Inc. All rights reserved.
Information in this document is subject to change without notice.