

Assembly Instructions for - 37159

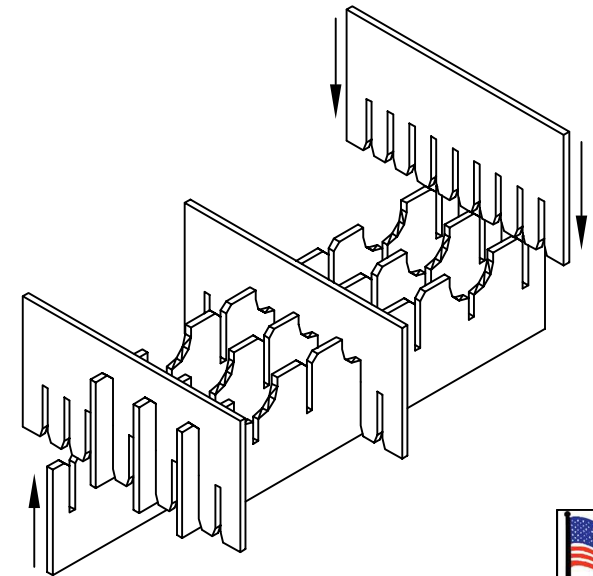
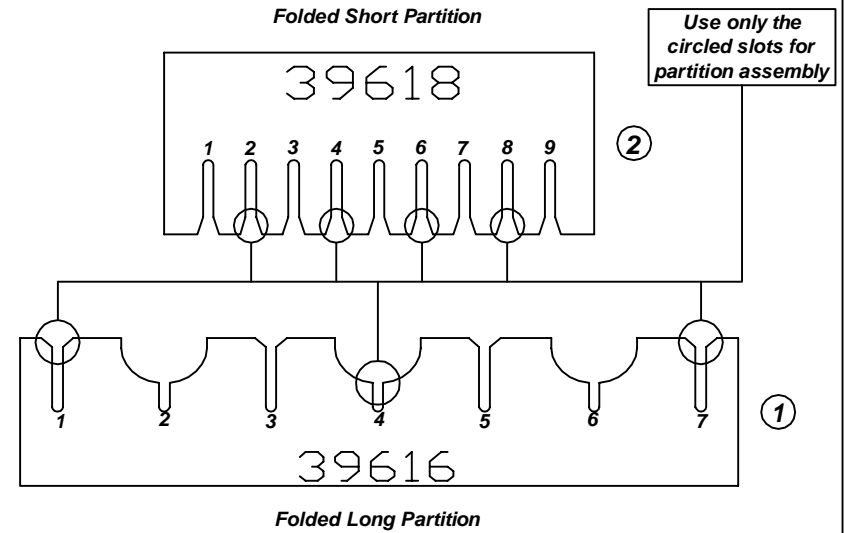
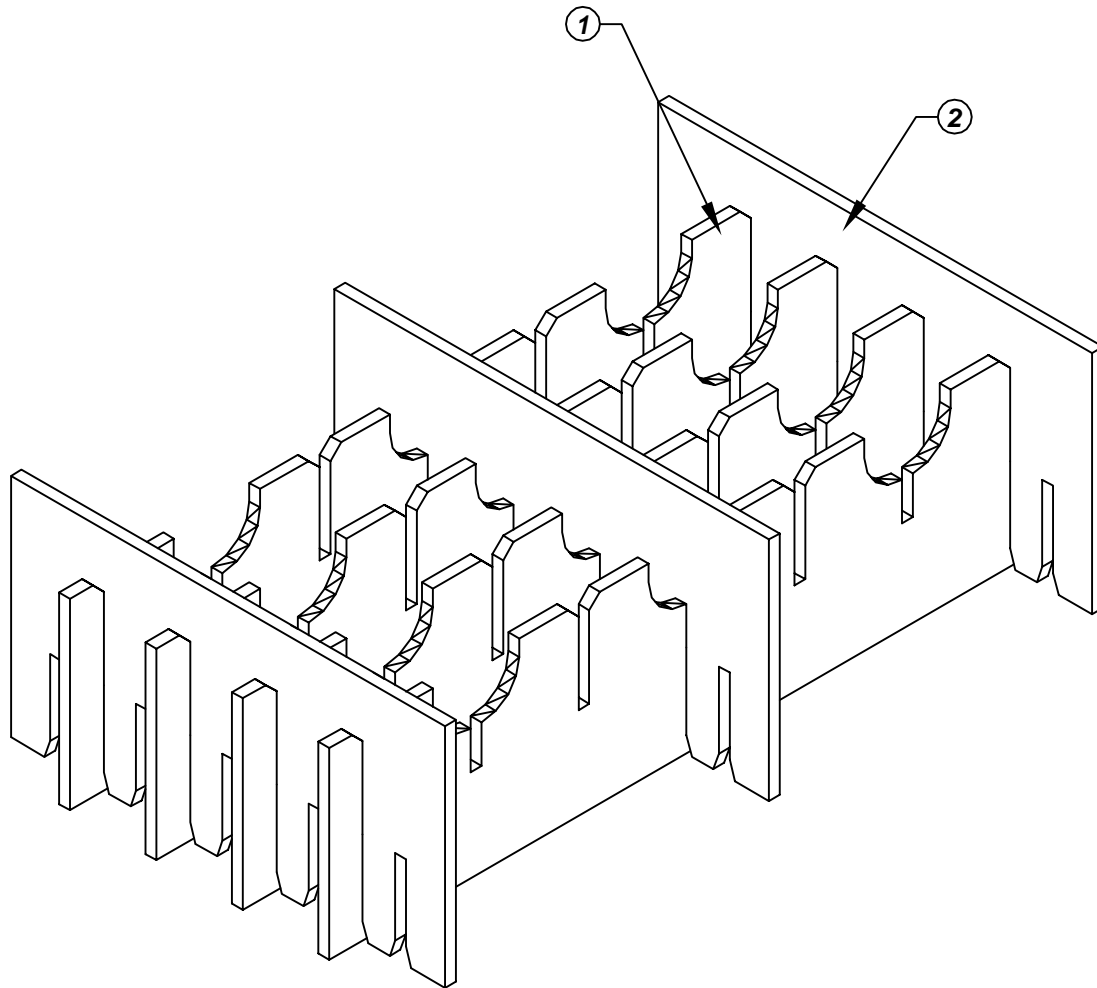

Made in America

F/N ①	Part # 39616	Dimensions: 8-11/16" x 16-13/16"	Description: 401-LP Long Partition	Qty: 4
F/N ②	Part # 39618	Dimensions: 10-11/16" x 10"	Description: 401-SP Short Partition	Qty: 3

37159 - 10 Cell Inplant Handler
Cell Size - 5-3/8" x 7-1/4" x 1-3/4"

Notes:
 For use with the following storage container & lid:
 37501 - Storage Container
 37550 - Lid

PROTEKTIVE PAK
 13520 MONTE VISTA AVENUE, CHINO, CA 91710
 PHONE (909) 627-2578, FAX (909) 363-7331
 ProtectivePak.com



DRAWING NUMBER
IPH-37159

DATE
 Nov.
 2007