

This tool is used to crimp: AMPLI-BOND Terminals, PLASTI-GRIP* Terminals, TERMINYL* Terminals and Splices, Pre-Insulated nylon Heavy Duty Terminals, Pre-Insulated AMPOWER* Terminals, and Sealed COPALUM* Terminals and Splices.*

Figure 1

1. INTRODUCTION

This instruction sheet provides application, maintenance, and inspection procedures for Crimping Head 1752787-1 shown in Figure 1. The crimping head accepts interchangeable die sets for a variety of heavy-duty terminals and splices for large wire sizes - within Size 8 through 4/0 AWG range. Refer to instructions packaged with specific die sets for compatible products, wire ranges, strip dimensions, and application procedures.

The crimping head is designed and recommended only for use with Foot Hydraulic Pump 1583659-1; Hand Hydraulic Pump 1583661-1, or Electric Hydraulic Pump 1583660-1 (115 Vac), or 1583660-2 (230 Vac).

Read these instructions, and all applicable references, before inserting any die assemblies and crimping any terminals or splices.

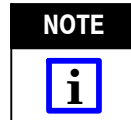

Dimensions on this sheet are in millimeters [with inches in brackets]. Figures are for reference only and are not drawn to scale.

2. DESCRIPTION

Main components of the crimping head are: a yoke which houses the stationary die and retains the terminal assembly for crimping, a removable latch pin which allows pivoting of the yoke on the pivot pin (typically required for splice terminations), a cylinder which contains the head's hydraulic chamber, a piston (ram) which holds and controls the moving die, and a quick connect/disconnect coupler which mates with the coupler on the hose to release or supply pressure.



To avoid injury when using hydraulic crimping equipment, observe the following precautions:

- Do NOT modify the crimping equipment in any way.
- Use only dies, terminals, and wire specified for the head.
- Do NOT perform repairs other than those specified in the instructional material supplied with the equipment.

3. CRIMPING HEAD INSTALLATION

Each crimping head is shipped with a coating of lubricating oil to prevent rust and corrosion. Wipe the oil off before installing the crimping head on the power unit. Note that the crimping head is shipped without oil inside the cylinder. To install crimping head, proceed as follows.



Make sure that hydraulic pressure to the hose is released and that power supply is disconnected to electric power unit, if applicable.

1. Remove protective dust caps from both quick connect/disconnect couplers.
2. Hold hose vertically to prevent oil spillage. Attach hose to coupling section on head. Thread properly and tighten securely.



Oil flow must be unobstructed between power unit and crimping head. Make sure that all couplers are fully mated and tightened.

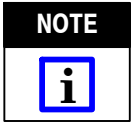

If crimping head must be removed after being in production, pressure must be released in the hydraulic system before head is removed.
 - If using Electric Hydraulic Pump 1583660-[], DISCONNECT POWER UNIT FROM POWER SUPPLY.
 - If using Foot Hydraulic Pump 1583659-1, depress pressure release pedal, or if using Hand Hydraulic Pump 1583661-1, activate the pressure release knob.

2. Loosen setscrew in yoke. Refer to die set instructions and insert stationary (upper) die which includes the nest area into well of yoke. Tighten setscrew.
3. Activate power unit to advance ram until setscrew is visible (about 12.7 mm [.50 in.]). Loosen setscrew.
4. Insert moving (lower) die, which serves as the indenter, into ram well, making sure that moving die is properly oriented to mate with stationary die. Tighten setscrew.
5. Close yoke and secure with latch pin.
6. Slowly close dies to ensure proper alignment.
7. Complete the cycle and return the ram to the DOWN position.

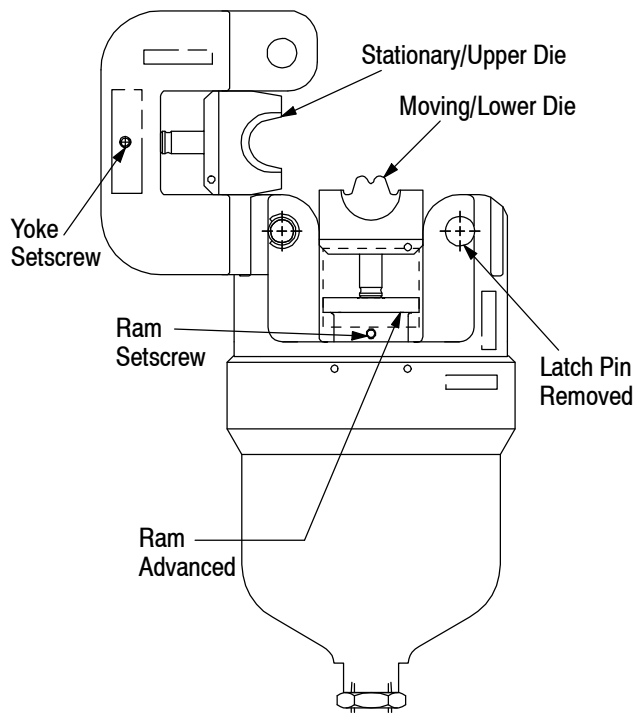

Figure 2

4. DIE INSERTION AND REMOVAL (Figure 2)



Avoid personal injury. When using power unit, exercise caution to avoid accidentally depressing foot pedal or hand control when installing or changing dies.

Make sure that matched die set, terminal, and wire size are compatible. With crimping head properly installed, refer to die set instructions, and insert/change die set as follows:

1. Remove latch pin and open yoke on crimping head.



Always ensure that latch pin is fully inserted or damage may occur to yoke, dies, or latch pin.

5. CRIMPING PROCEDURE



Avoid personal injury. When operating power unit, exercise caution while holding terminals, splices, or wire near crimping area.

The following crimping procedure provides general information. Refer to instructions packaged with individual die sets for specific products, wire sizes, strip dimensions, positioning of terminals and splices in the dies, and crimping procedures.

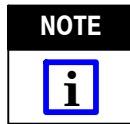

Never operate the power unit without having a crimping head attached to the hose.

1. Insert terminal or splice in the stationary (upper) die according to instructions packaged with the dies. Make sure the latch pin is secure before activating the power unit.
2. Slowly advance moving (lower) die with short, quick strokes until terminal or splice is secure.
3. Insert the stripped wire.
4. Cycle tool to complete crimp. Remove crimped terminal or splice.

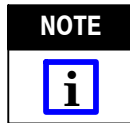

If the splice or terminal sticks in the die after crimping, apply a rocking action to remove it from the die.

6. INSPECTION/MAINTENANCE



Make sure hydraulic pressure is released and power supply is disconnected before following inspection and maintenance procedures, unless otherwise specified in the procedure.

Each crimping head is assembled and inspected before shipment. Tyco Electronics recommends that the crimping head be inspected immediately upon its arrival at your facility, and at regularly scheduled intervals, to ensure that the crimping head has not been damaged during handling. Frequency of inspection depends upon the following: care, amount of use, and handling of the head; type and size of products crimped; degree of operator skill; and environmental conditions.

6.1. Cleaning

Remove accumulations of dirt and grease on the crimping head, especially in areas where dies are installed and terminals are crimped. Clean the entire head frequently with a clean, lint-free cloth.

6.2. Visual Inspection

Refer to Figure 3 and proceed as follows:

1. With hydraulic pressure released, inspect the assembled head for nicks, scratches, and cracks. Inspect for cracks especially at the corners of the yoke and around the top of the cylinder.
2. Inspect pivot pin holes and latch pin holes for wear. Replace parts, as needed.

3. Activate power unit. Raise ram to UP position. Inspect flat and round surfaces of ram for galling (fretting or wear by friction), cracks, or oil leakage. Release pressure and make sure that ram retracts smoothly.
4. If head shows evidence of galling, cracks, oil leakage, or rough cycling, return the crimping head to Tyco Electronics for repairs. (Refer to Section 7, REPLACEMENT AND REPAIR).



Once a year, or every 7,500 cycles (whichever comes first), the hydraulic head should be returned to Tyco Electronics for magnetic particle inspection. Additionally, inspect and service the head (as described in Figure 3) every month or 1,000 cycles. Refer to Instruction Sheet 408-8909.

6.3. Crimping Head Check-Out Procedure

If the ram fails to return to the DOWN position after completion of a crimping cycle, the cause may be in the crimping head. To determine whether or not the trouble is in the crimping head, proceed as follows:

A. Electric Hydraulic Pump 1583660- []

Press the retract/release button on the hand remote pendant or foot remote, and hold for several seconds. This will release any pressure in the hydraulic system. If the ram returns to DOWN position, the trouble is **NOT** in the crimping head. If ram does not return, ensure that the coupler is fully engaged. If coupler is engaged and ram still does not go DOWN, return the crimping head to Tyco Electronics for repairs.

B. Foot Hydraulic Pump 1583659- 1

Depress the pressure release pedal.

C. Hand Hydraulic Pump 1583661- 1

Activate the pressure release knob.

7. REPLACEMENT AND REPAIR

Customer-replaceable parts are listed in Figure 4. A complete inventory can be stocked and controlled to prevent lost time when replacement of parts is necessary. Order replacement parts through your Tyco Electronics Representative, or call 1-800-526-5142, or send a facsimile of your purchase order to 1-717-986-7605, or write to:

CUSTOMER SERVICE (38-35)
 TYCO ELECTRONICS CORPORATION
 PO BOX 3608
 HARRISBURG PA 17105-3608

Tools may also be returned to Tyco Electronics for evaluation and repair. For tool repair service, contact a Tyco Electronics Representative at 1-800-526-5136.

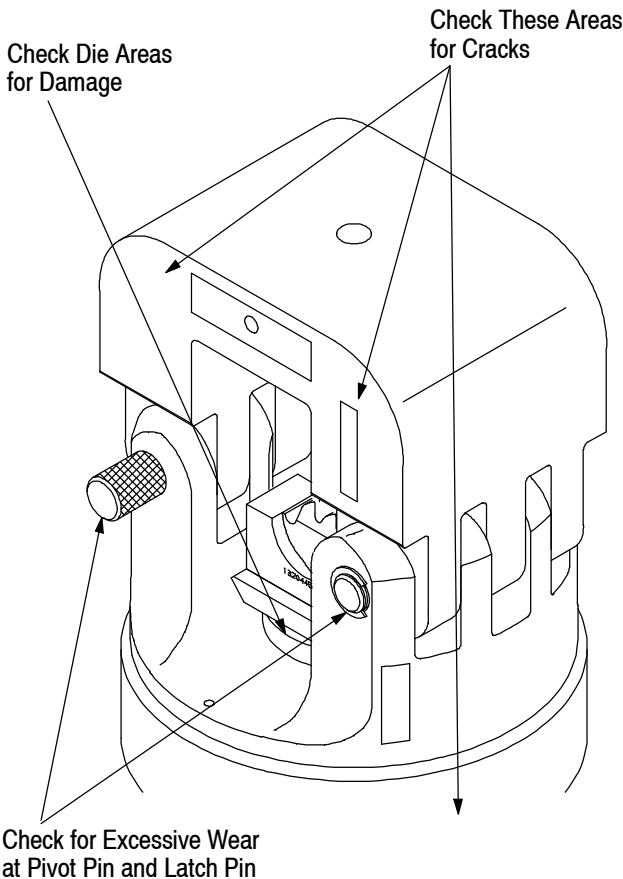
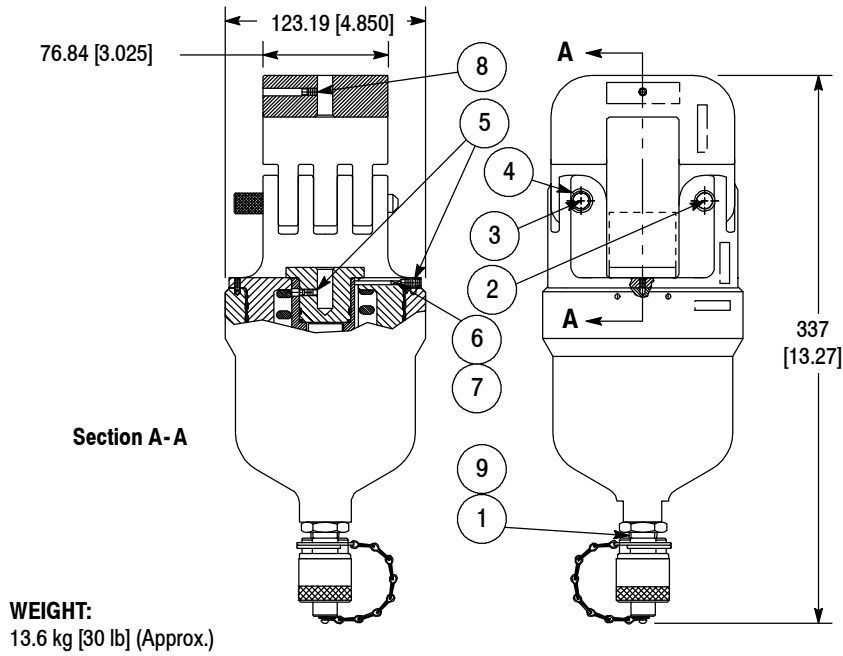

Figure 3

8. REVISION SUMMARY

- Addition of "ORIGINAL INSTRUCTIONS"



REPLACEMENT PARTS FOR CRIMPING HEAD 1752787-1

ITEM	PART NUMBER	DESCRIPTION	QTY PER HEAD
1	311470-1	COUPLER, Quick Connect/Disconnect	1
2	306209-8	PIN, Removable Latch	1
3	8-59558-5	PIN, Pivot	1
4	1-21045-1	RING, Retaining	1
5	21061-9	SETSCREW	2
6	4-23147-7	SPRING, Compression	1
7	1-21919-6	PIN, Dowel	1
8	4-21012-0	SETSCREW	1
9	23150-3	NIPPLE, Hex	1

Figure 4