



EL3-F2415

ELF3

CYLINDRICAL PHOTOELECTRIC SENSORS

SICK
Sensor Intelligence.



Illustration may differ



Ordering information

| Type | Part no. |
|-----------|----------|
| EL3-F2415 | 1043961 |

Other models and accessories → www.sick.com/ELF3

Detailed technical data

Features

| | |
|--|---------------------------------------|
| Sensor/ detection principle | Photoelectric retro-reflective sensor |
| Dimensions (W x H x D) | 23.8 mm x 45.4 mm x 33.6 mm |
| Housing design (light emission) | Hybrid |
| Thread diameter (housing) | M18 |
| Sensing range max. | 0.1 m ... 4.8 m ¹⁾ |
| Sensing range | 0.1 m ... 3 m ¹⁾ |
| Type of light | Visible red light |
| Light source | LED ²⁾ |
| Light spot size (distance) | 125 mm x 125 mm (1 m) |
| Wave length | 660 nm |
| Adjustment | None |

¹⁾ Reflector PL80A.

²⁾ Average service life: 100,000 h at T_U = +25 °C.

Mechanics/electronics

| | |
|--------------------------|-----------------------------------|
| Supply voltage | 10 V DC ... 30 V DC ¹⁾ |
| Ripple | < 5 V _{pp} ²⁾ |
| Power consumption | 20 mA ³⁾ |
| Switching output | PNP |

¹⁾ Limit values.

²⁾ May not exceed or fall below U_V tolerances.

³⁾ Without load.

⁴⁾ With light/dark ratio 1:1.

⁵⁾ Do not bend below 0 °C.

⁶⁾ A = V_S connections reverse-polarity protected.

⁷⁾ D = outputs overcurrent and short-circuit protected.

⁸⁾ Reference voltage: 50 V DC.

| | |
|---------------------------------------|---|
| Switching mode | Dark switching |
| Output current I_{max} | 50 mA |
| Switching frequency | 400 Hz ⁴⁾ |
| Connection type | Cable, 3-wire, 2 m ⁵⁾ |
| Cable material | PVC |
| Conductor cross-section | 0.23 mm ² |
| Circuit protection | A ⁶⁾ D ⁷⁾ |
| Protection class | III ⁸⁾ |
| Weight | 0.036 kg, 0.08 lbs |
| Polarisation filter | ✓ |
| Housing material | Plastic, Glass fiber reinforced ABS plastic |
| Enclosure rating | IP67 |
| Items supplied | Mounting nut M18 |
| Ambient operating temperature | -25 °C ... +50 °C |
| Ambient storage temperature | -40 °C ... +70 °C |

1) Limit values.

2) May not exceed or fall below U_y tolerances.

3) Without load.

4) With light/dark ratio 1:1.

5) Do not bend below 0 °C.

6) A = V_S connections reverse-polarity protected.

7) D = outputs overcurrent and short-circuit protected.

8) Reference voltage: 50 V DC.

Classifications

| | |
|-----------------------|----------|
| ECl@ss 5.0 | 27270902 |
| ECl@ss 5.1.4 | 27270902 |
| ECl@ss 6.0 | 27270902 |
| ECl@ss 6.2 | 27270902 |
| ECl@ss 7.0 | 27270902 |
| ECl@ss 8.0 | 27270902 |
| ECl@ss 8.1 | 27270902 |
| ECl@ss 9.0 | 27270902 |
| ETIM 5.0 | EC002717 |
| ETIM 6.0 | EC002717 |
| UNSPSC 16.0901 | 39121528 |

Connection diagram

Cd-043

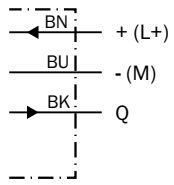

Characteristic curve

EL3

% of sensing range

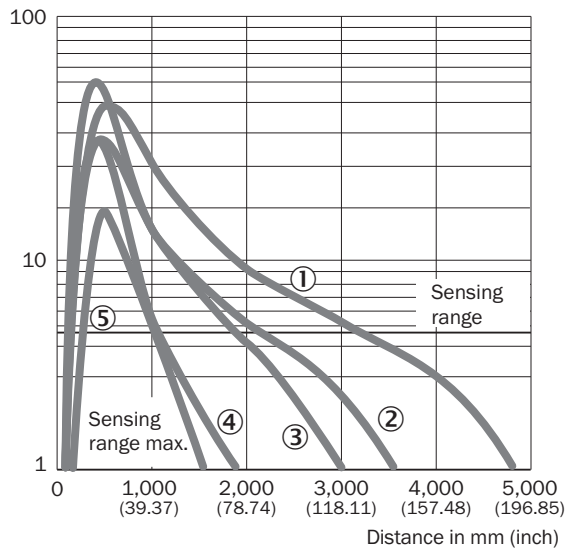

- ① Reflector PL80A
- ② Reflector P250
- ③ Reflector PL40A
- ④ Reflector PL20A
- ⑤ Reflective tape REF-Plus

Sensing range diagram

EL3, EL4

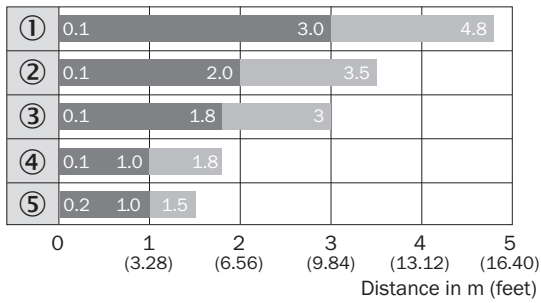

■ Sensing range ■ Sensing range max.

- ① Reflector PL80A
- ② Reflector P250
- ③ Reflector PL40A
- ④ Reflector PL20A
- ⑤ Reflective tape REF-Plus





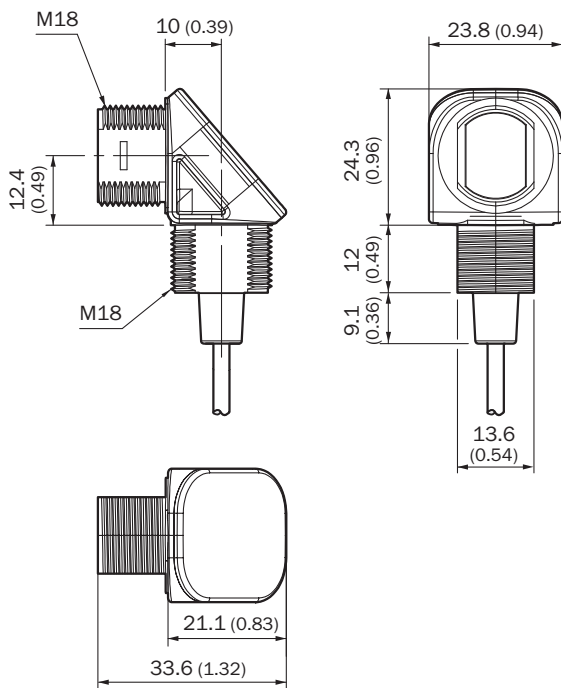

Dimensional drawing (Dimensions in mm (inch))

ET3, EL3, cable



Recommended accessories

Other models and accessories → www.sick.com/ELF3

| | Brief description | Type | Part no. |
|--|---|------------|----------|
| Reflectors | | | |
|  | Rectangular, screw connection, 47 mm x 47 mm, PMMA/ABS, Screw-on, 2 hole mounting | P250 | 5304812 |
|  | Rectangular, screw connection, 38 mm x 15 mm, PMMA/ABS, Screw-on, 2 hole mounting | PL20A | 1012719 |
|  | Rectangular, screw connection, 56 mm x 28 mm, PMMA/ABS, Screw-on, 2 hole mounting | PL30A | 1002314 |
|  | Rectangular, screw connection, 37 mm x 56 mm, PMMA/ABS, Screw-on, 2 hole mounting | PL40A | 1012720 |
|  | Rectangular, screw connection, 80 mm x 80 mm, PMMA/ABS, Screw-on, 2 hole mounting | PL80A | 1003865 |
|  | Self-adhesive | REF-IRF-56 | 5314244 |
|  | Round, screw connection, PMMA/ABS, Center hole mounting, screw-on | C110A | 5304549 |

SICK AT A GLANCE

SICK is one of the leading manufacturers of intelligent sensors and sensor solutions for industrial applications. A unique range of products and services creates the perfect basis for controlling processes securely and efficiently, protecting individuals from accidents and preventing damage to the environment.

We have extensive experience in a wide range of industries and understand their processes and requirements. With intelligent sensors, we can deliver exactly what our customers need. In application centers in Europe, Asia and North America, system solutions are tested and optimized in accordance with customer specifications. All this makes us a reliable supplier and development partner.

Comprehensive services complete our offering: SICK LifeTime Services provide support throughout the machine life cycle and ensure safety and productivity.

For us, that is “Sensor Intelligence.”

WORLDWIDE PRESENCE:

Contacts and other locations – www.sick.com