

LOC	DIST	REVISIONS					
E	B	P	LTR	DESCRIPTION	DATE	DWN	APVD
		BA		NEW RELEASE	08-JAN-09	SM	St.P

FOR FURTHER INFORMATION SEE DATA SHEET FOR
CRG SERIES-THICK FILM CHIP RESISTORS

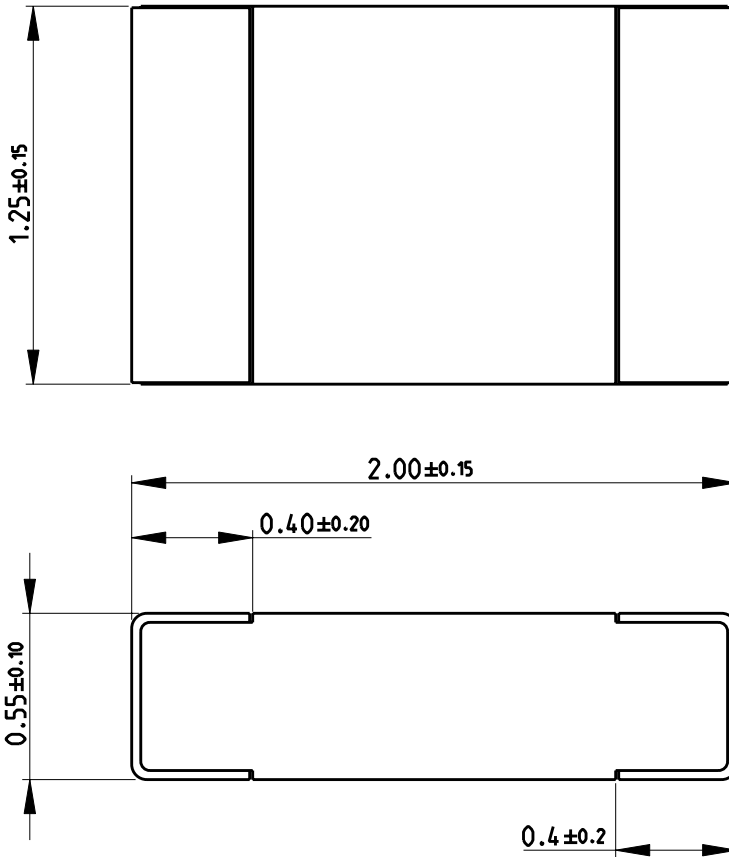

RoHS Compliant

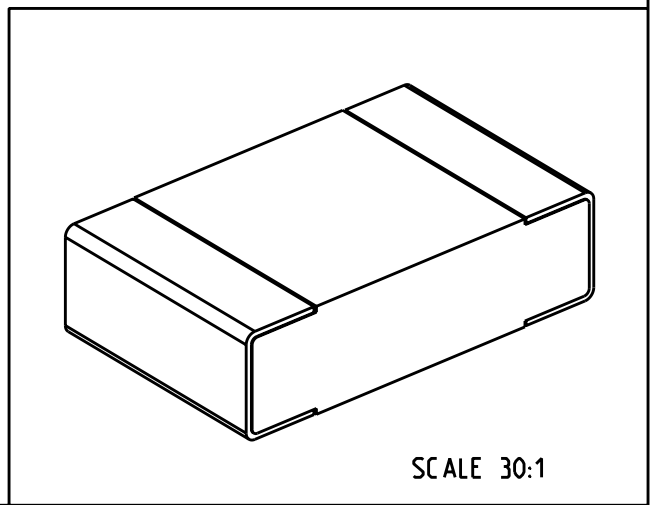

SCALE 30:1

2009

RELEASED FOR PUBLICATION

THIS DRAWING IS UNPUBLISHED.

BY TYCO ELECTRONICS CORPORATION. ALL RIGHTS RESERVED.

© COPYRIGHT 2009

DIMENSIONS: mm	DWN SUBHASH.M	08-JAN-09	MATERIAL	-	FINISH	-
	CHK PRAKASH.S	08-JAN-09	Tyco Electronics Corporation Dorcan, Swindon, SN3 5HH			
TOLERANCES UNLESS OTHERWISE SPECIFIED:	APVD STEPHEN.P	08-JAN-09				
0 PLC ±0.5	PRODUCT SPEC	-	NAME THICK FILM CHIP RESISTORS			
1 PLC ±0.2	APPLICATION SPEC	-	SERIES CRG 0805			
2 PLC ±0.1			SIZE	CAGE CODE	DRAWING NO	RESTRICTED TO
3 PLC ±-			A 4	00779	C- 1623207	-
4 PLC ±-			CUSTOMER DRAWING			
ANGLES ±5°	WEIGHT	-	SCALE	40:1	SHEET 1 OF 1	REV BA