

APPROVAL SHEET

WLCM0603

WLCM1005

WLCM1608

Multi-Layer Ceramic High Frequency Inductors



*Contents in this sheet are subject to change without prior notice.

FEATURES

1. Ceramic structure provides high reliability · high productivity.
2. Excellence Q and SRF characteristics for RF application.
3. Wide range inductance and various tolerance options.

APPLICATIONS

1. Communication system front-end circuit: GSM/3G/LTE, Wi-Fi, GPS.
2. Cabel/Terrestrial/BS Tuner, Bluetooth, Wireless Audio, Remote control.
3. M2M: ZigBee, Proprietary wireless.
4. EMI solution in high frequency circuits.

SHAPE and DIMENSION

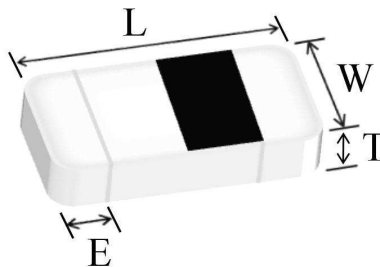

Unit: mm

WLCM Series	L	W	T	E (Min/Max)	Packing Qty (pcs/reel)
WLCM0603 (EIA 0201)	0.60±0.03	0.30±0.03	0.30±0.03	0.10~0.20	15,000
WLCM1005 (EIA 0402)	1.00±0.10	0.50±0.10	0.50±0.10	0.10~0.30	10,000
WLCM1608 (EIA 0603)	1.60±0.15	0.80±0.15	0.80±0.15	0.20~0.60	4,000

Ordering Information

WL	CM	0603	Z0	S	1N2	T	B
Product Code	Series	Dimensions	Series extension	Tolerance	Value	Packing Code	
WL: Inductor	Ceramic multilayer inductor.	0603:EIA 0201 1005:EIA 0402 1608:EIA 0603	Z0:STD Z2:STD	B: ± 0.1nH C: ± 0.2nH S: ± 0.3nH G: ± 2% H: ± 3% J: ± 5%	1N2 =1.2nH 12N=12nH R10=100nH =0.10uH	T=7" Reeled (Paper tape)	B:STD

Electrical Characteristics

- WLCM0603 series (EIA 0201)

Operating Temperature range: -55°C to 125°C

Walsin Part Number	L(nH)	Tolerance	Q Min	Typical Q @ Frequency (MHz)	SRF (MHz)	RDC (Ω)	Rated Current (mA) Max.
					Min.	Max.	
WLCM0603Z0□0N3TB	0.3	B	4	100	10,000	0.07	850
WLCM0603Z0□0N4TB	0.4	B	4	100	10,000	0.07	850
WLCM0603Z0□0N5TB	0.5	B	4	100	10,000	0.08	800
WLCM0603Z0□0N6TB	0.6	B	4	100	10,000	0.08	800
WLCM0603Z0□0N7TB	0.7	B	4	100	10,000	0.09	750
WLCM0603Z0□0N8TB	0.8	B	4	100	10,000	0.10	750
WLCM0603Z0□0N9TB	0.9	B	4	100	10,000	0.10	750
WLCM0603Z0□1N0TB	1.0	B, C, S	4	100	10,000	0.14	600
WLCM0603Z0□1N1TB	1.1	B, C, S	4	100	10,000	0.14	600
WLCM0603Z0□1N2TB	1.2	B, C, S	4	100	10,000	0.14	600
WLCM0603Z0□1N3TB	1.3	B, C, S	4	100	10,000	0.14	600
WLCM0603Z0□1N4TB	1.4	B, C, S	4	100	10,000	0.18	550
WLCM0603Z0□1N5TB	1.5	B, C, S	4	100	10,000	0.18	550
WLCM0603Z0□1N6TB	1.6	B, C, S	4	100	10,000	0.18	500
WLCM0603Z0□1N7TB	1.7	B, C, S	4	100	10,000	0.19	500
WLCM0603Z0□1N8TB	1.8	B, C, S	4	100	10,000	0.19	500
WLCM0603Z0□1N9TB	1.9	B, C, S	4	100	10,000	0.20	450
WLCM0603Z0□2N0TB	2.0	B, C, S	4	100	10,000	0.20	450
WLCM0603Z0□2N1TB	2.1	B, C, S	4	100	10,000	0.20	450
WLCM0603Z0□2N2TB	2.2	B, C, S	4	100	10,000	0.22	450
WLCM0603Z0□2N3TB	2.3	B, C, S	4	100	10,000	0.22	450
WLCM0603Z0□2N4TB	2.4	B, C, S	4	100	10,000	0.24	450
WLCM0603Z0□2N5TB	2.5	B, C, S	4	100	10,000	0.24	450
WLCM0603Z0□2N6TB	2.6	B, C, S	4	100	10,000	0.25	450
WLCM0603Z0□2N7TB	2.7	B, C, S	5	100	10,000	0.25	450
WLCM0603Z0□2N9TB	2.9	B, C, S	5	100	9,500	0.28	450
WLCM0603Z0□3N0TB	3.0	B, C, S	5	100	9,500	0.28	450
WLCM0603Z0□3N1TB	3.1	B, C, S	5	100	9,500	0.28	450
WLCM0603Z0□3N2TB	3.2	B, C, S	5	100	9,500	0.30	450
WLCM0603Z0□3N3TB	3.3	B, C, S	5	100	9,500	0.30	450
WLCM0603Z0□3N4TB	3.4	B, C, S	5	100	8,000	0.30	400
WLCM0603Z0□3N5TB	3.5	B, C, S	5	100	8,000	0.30	400
WLCM0603Z0□3N6TB	3.6	B, C, S	5	100	8,000	0.30	400
WLCM0603Z0□3N7TB	3.7	B, C, S	5	100	8,000	0.30	400
WLCM0603Z0□3N8TB	3.8	B, C, S	5	100	6,500	0.30	400
WLCM0603Z0□3N9TB	3.9	B, C, S	5	100	6,500	0.30	400
WLCM0603Z0□4N3TB	4.3	B, C, S	5	100	6,500	0.40	350
WLCM0603Z0□4N7TB	4.7	B, C, S	5	100	6,500	0.40	350
WLCM0603Z0□5N1TB	5.1	B, C, S	5	100	6,500	0.40	350

Walsin Part Number	L(nH)	Tolerance	Q Min	Typical Q @ Frequency (MHz)	SRF (MHz)	RDC (Ω)	Rated Current (mA) Max.
					Min.	Max.	
WLCM0603Z0□5N6TB	5.6	B, C, S	5	100	6,000	0.40	350
WLCM0603Z0□6N2TB	6.2	B, C, S	5	100	6,000	0.44	300
WLCM0603Z0□6N8TB	6.8	H, J	5	100	5,400	0.50	300
WLCM0603Z0□7N5TB	7.5	H, J	5	100	4,800	0.53	300
WLCM0603Z0□8N2TB	8.2	H, J	5	100	4,800	0.55	250
WLCM0603Z0□9N1TB	9.1	H, J	5	100	4,500	0.62	250
WLCM0603Z0□10NTB	10	H, J	5	100	4,500	0.65	250
WLCM0603Z0□12NTB	12	H, J	5	100	3,700	0.70	250
WLCM0603Z0□15NTB	15	H, J	5	100	2,200	0.80	250
WLCM0603Z0□18NTB	18	H, J	5	100	2,200	0.90	200
WLCM0603Z0□22NTB	22	H, J	5	100	2,000	1.20	150
WLCM0603Z0□27NTB	27	H, J	4	100	1,800	1.80	140
WLCM0603Z0□33NTB	33	J	4	100	1,700	2.10	120
WLCM0603Z0□39NTB	39	J	4	100	1,500	2.40	120

Typical Electrical Characteristic

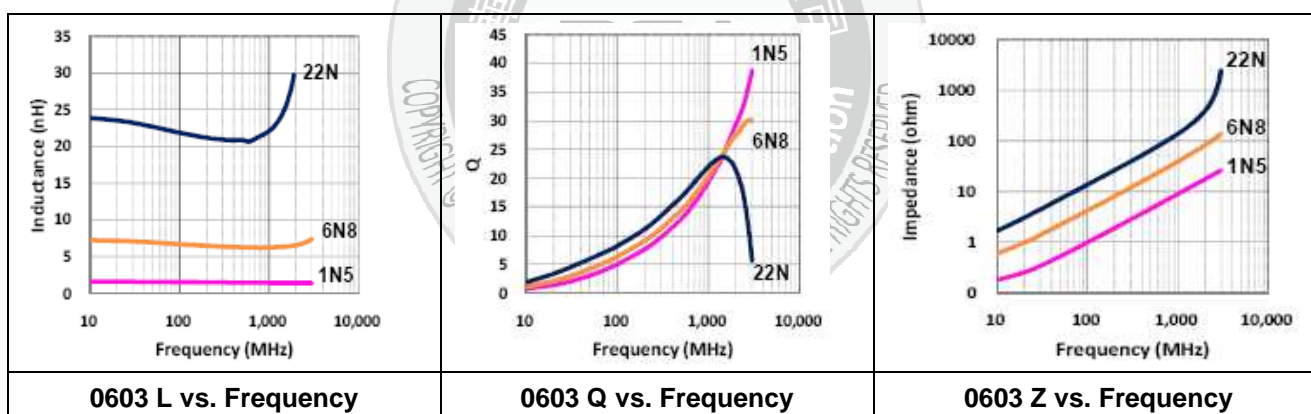

● WLCM1005 series (EIA 0402)

Operating Temperature range: -55°C to 125°C

Walsin Part Number	L(nH)	Tolerance	Q Min	Typical Q @ Frequency (MHz)	SRF (MHz)		RDC (Ω)	Rated Current (mA) Max
					Min.	Typ.	Max.	
WLCM1005Z0□0N3TB	0.3	B	8	100	10,000	>13,000	0.08	1000
WLCM1005Z0□0N4TB	0.4	B	8	100	10,000	>13,000	0.08	1000
WLCM1005Z0□0N5TB	0.5	B	8	100	10,000	>13,000	0.08	1000
WLCM1005Z0□0N6TB	0.6	B	8	100	10,000	>13,000	0.08	1000
WLCM1005Z0□0N7TB	0.7	B	8	100	10,000	>13,000	0.08	1000
WLCM1005Z0□0N8TB	0.8	B	8	100	10,000	>13,000	0.08	1000
WLCM1005Z0□1N0TB	1.0	B, C, S	8	100	10,000	>13,000	0.08	1000
WLCM1005Z0□1N1TB	1.1	B, C, S	8	100	10,000	>13,000	0.08	1000
WLCM1005Z0□1N2TB	1.2	B, C, S	8	100	10,000	>13,000	0.09	1000
WLCM1005Z0□1N3TB	1.3	B, C, S	8	100	10,000	>13,000	0.09	1000
WLCM1005Z0□1N5TB	1.5	B, C, S	8	100	10,000	>13,000	0.10	1000
WLCM1005Z0□1N6TB	1.6	B, C, S	8	100	10,000	>13,000	0.10	1000
WLCM1005Z0□1N8TB	1.8	B, C, S	8	100	10,000	12220	0.12	900
WLCM1005Z0□2N0TB	2.0	B, C, S	8	100	10,000	12890	0.12	900
WLCM1005Z0□2N2TB	2.2	B, C, S	8	100	10,000	12430	0.13	900
WLCM1005Z0□2N4TB	2.4	B, C, S	8	100	10,000	12320	0.13	800
WLCM1005Z0□2N7TB	2.7	B, C, S	8	100	6,000	10070	0.16	800
WLCM1005Z0□3N0TB	3.0	B, C, S	8	100	6,000	8760	0.16	800
WLCM1005Z0□3N3TB	3.3	B, C, S	8	100	6,000	8120	0.16	800
WLCM1005Z0□3N6TB	3.6	B, C, S	8	100	6,000	8200	0.20	700
WLCM1005Z0□3N9TB	3.9	B, C, S	8	100	6,000	8390	0.20	700
WLCM1005Z0□4N3TB	4.3	B, C, S	8	100	6,000	7500	0.20	700
WLCM1005Z0□4N7TB	4.7	B, C, S	8	100	6,000	7010	0.20	700
WLCM1005Z0□5N1TB	5.1	B, C, S	8	100	5,300	6340	0.23	600
WLCM1005Z0□5N6TB	5.6	B, C, S	8	100	4,500	5760	0.23	600
WLCM1005Z0□6N2TB	6.2	B, C, S	8	100	4,500	5490	0.25	600
WLCM1005Z0□6N8TB	6.8	G, H, J	8	100	4,500	5430	0.25	600
WLCM1005Z0□7N5TB	7.5	G, H, J	8	100	4,200	5000	0.28	500
WLCM1005Z0□8N2TB	8.2	G, H, J	8	100	3,700	4660	0.28	500
WLCM1005Z0□9N1TB	9.1	G, H, J	8	100	3,400	4400	0.30	500
WLCM1005Z0□10NTB	10	G, H, J	8	100	3,400	4120	0.30	500
WLCM1005Z0□12NTB	12	G, H, J	8	100	3,000	3820	0.45	400
WLCM1005Z0□15NTB	15	G, H, J	8	100	2,500	3350	0.55	400
WLCM1005Z0□18NTB	18	G, H, J	8	100	2,200	2970	0.65	300
WLCM1005Z0□22NTB	22	G, H, J	8	100	1,900	2640	0.70	300

Walsin Part Number	L(nH)	Tolerance	Q Min	Typical Q @ Frequency (MHz)	SRF (MHz)		RDC (Ω)	Rated Current (mA) Max
					Min.	Typ.	Max.	
WLCM1005Z0□27NTB	27	G, H, J	8	100	1,700	2370	0.80	300
WLCM1005Z0□33NTB	33	G, H, J	8	100	1,600	2040	0.90	200
WLCM1005Z0□39NTB	39	G, H, J	8	100	1,200	1800	1.00	200
WLCM1005Z0□47NTB	47	G, H, J	8	100	1,100	1660	1.10	200
WLCM1005Z0□56NTB	56	G, H, J	8	100	1,000	1560	1.10	200
WLCM1005Z0□68NTB	68	G, H, J	8	100	800	1330	1.20	200
WLCM1005Z0□82NTB	82	J	8	100	600	1160	1.30	200
WLCM1005Z0□R10TB	100	J	8	100	600	1020	1.60	200
WLCM1005Z0□R12TB	120	J	8	100	600	860	1.60	150
WLCM1005Z0□R15TB	150	J	8	100	550	800	3.20	140

Typical Electrical Characteristic

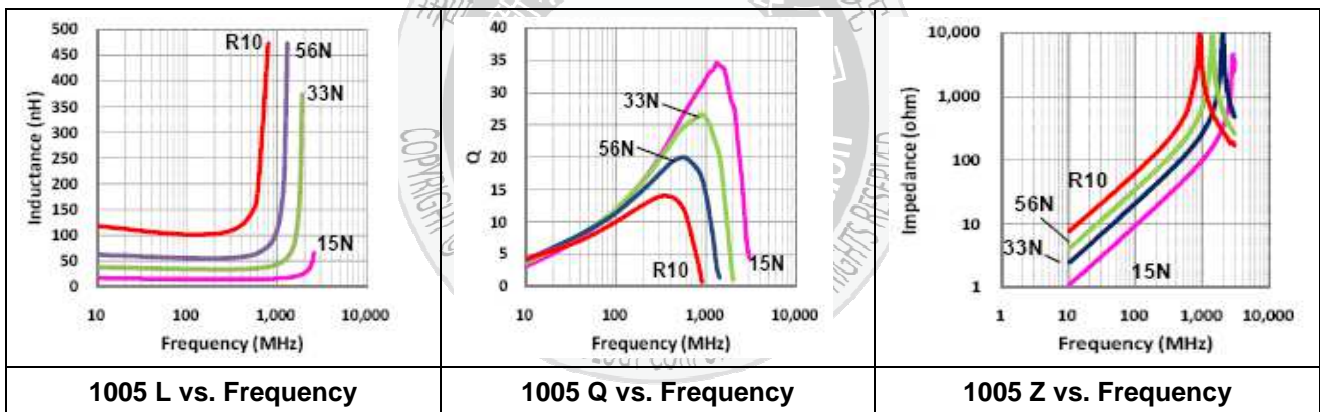

Electrical Characteristics

- WLCM1608 series (EIA 0603)

Operating Temperature range: -55°C to 125°C

Walsin Part Number	L (nH)	Tolerance	Q (Min.)	Freq. (MHz)	DCR(Ω) Max.	S.R.F (MHz) Min.	Rated Current (mA) Max.
WLCM1608Z2□1N0TB	1.0	S	8	100	0.05	10,000	1,000
WLCM1608Z2□1N2TB	1.2	S	8	100	0.05	10,000	1,000
WLCM1608Z2□1N5TB	1.5	S	8	100	0.10	10,000	1,000
WLCM1608Z2□1N8TB	1.8	S	8	100	0.10	10,000	1,000
WLCM1608Z2□2N2TB	2.2	S	8	100	0.10	8,000	1,000
WLCM1608Z2□2N7TB	2.7	S	10	100	0.13	7,000	1,000
WLCM1608Z2□3N3TB	3.3	S	10	100	0.13	6,000	1,000
WLCM1608Z2□3N9TB	3.9	S	10	100	0.15	6,000	1,000
WLCM1608Z2□4N7TB	4.7	S	10	100	0.20	5,000	1,000
WLCM1608Z2□5N6TB	5.6	S	10	100	0.23	4,000	600
WLCM1608Z2□6N8TB	6.8	J	10	100	0.25	4,000	700
WLCM1608Z2□8N2TB	8.2	J	10	100	0.28	3,500	600
WLCM1608Z2□10NTB	10	J	12	100	0.30	3,400	600
WLCM1608Z2□12NTB	12	J	12	100	0.35	2,600	600
WLCM1608Z2□15NTB	15	J	12	100	0.40	2,300	600
WLCM1608Z2□18NTB	18	J	12	100	0.45	2,000	600
WLCM1608Z2□22NTB	22	J	12	100	0.50	1,600	600
WLCM1608Z2□27NTB	27	J	12	100	0.55	1,400	600
WLCM1608Z2□33NTB	33	J	12	100	0.60	1,200	600
WLCM1608Z2□39NTB	39	J	12	100	0.65	1,100	500
WLCM1608Z2□47NTB	47	J	12	100	0.70	900	500
WLCM1608Z2□56NTB	56	J	12	100	0.75	900	500
WLCM1608Z2□68NTB	68	J	12	100	0.85	700	400
WLCM1608Z2□82NTB	82	J	12	100	0.95	600	300
WLCM1608Z2□R10TB	100	J	12	100	1.00	600	300
WLCM1608Z2□R12TB	120	J	8	50	1.20	500	300
WLCM1608Z2□R15TB	150	J	8	50	1.20	500	300
WLCM1608Z2□R18TB	180	J	8	50	1.30	400	300
WLCM1608Z2□R22TB	220	J	8	50	1.50	400	300
WLCM1608Z2□R27TB	270	J	8	50	1.90	400	200
WLCM1608Z2□R33TB	330	J	8	50	2.10	350	200
WLCM1608Z2□R39TB	390	J	8	50	2.30	350	150
WLCM1608Z2□R47TB	470	J	8	50	2.60	300	150

Typical Electrical Characteristic

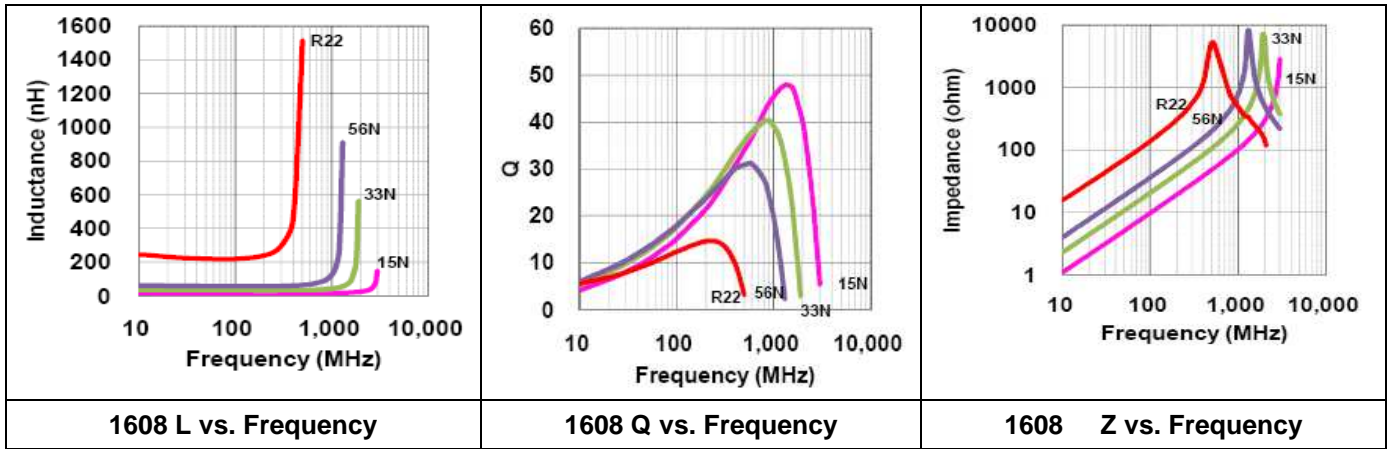

GENERAL TECHNICAL DATA

1. Operating temperature range: - 55°C ~ +125°C
2. Storage Condition: Less than 40°C and 70% RH
3. Storage Time: 6 months Max. (Size:0603、1005)
12month Max. (Size:1608)
4. Soldering method: Reflow

TEST INSTRUMENTS CONDITIONS

1. Agilent E4991A RF Impedance
2. Material Analyzer with fixture 16197A or equivalent (Size:0603、1005)
3. Material Analyzer with fixture 16192A (Size:1608)
4. Agilent 4338B Milliohm meter
5. Test Level : 500mV

LAND PATTERNS REFLOW SOLDERING

Solder land information :

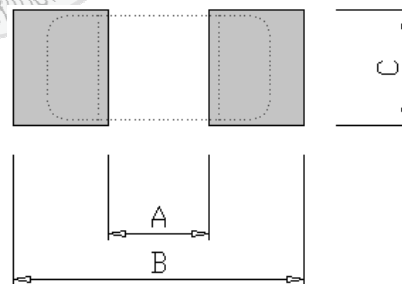

Size(mm)	A	B	C
0603 (EIA 0201)	0.2 ~ 0.3 (0.008 ~ 0.012)	0.8 ~ 0.9 (0.031 ~ 0.035)	0.2 ~ 0.3 (0.008 ~ 0.012)
1005 (EIA 0402)	0.4 (0.016)	1.4 ~ 1.5 (0.055 ~ 0.059)	0.5 ~ 0.6 (0.020 ~ 0.024)
1608 (EIA 0603)	0.7 (0.028)	1.9 ~ 2.3 (0.075 ~ 0.091)	0.6 ~ 0.8 (0.024 ~ 0.031)

Test condition & Requirements (WLCM series)

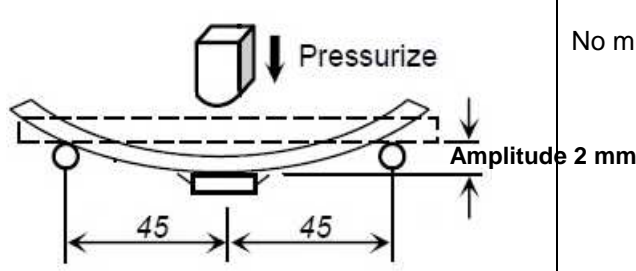
Item	Test Condition	Requirements
Temperature Cycle	<ol style="list-style-type: none"> 1. Temperature : -55 ~ +125°C 2. Cycle : 100 cycles 3. Dwell time : 30minutes 4. Measurement : at ambient temperature 24 hours after test completion 	<ol style="list-style-type: none"> 1. No mechanical damage 2. Inductance value should be within $\pm 10\%$ of the initial value 3. Q vale should be within $\pm 20\%$ of the initial value
Operational Life	<ol style="list-style-type: none"> 1. Temperature: 85 \pm 5°C 2. Testing time: 1000 hours 3. Applied current: Full rated current 4. Measurement: At ambient temperature 24 hours after test completion 	<ol style="list-style-type: none"> 1. No mechanical damage 2. Inductance value should be within $\pm 10\%$ of the initial value 3. Q vale should be within $\pm 20\%$ of the initial value
Biased Humidity	<ol style="list-style-type: none"> 1. Temperature : 40°C \pm 2°C 2. Humidity : 90 ~ 95 % RH 3. Test time : 1000 hours 4. Apply current : full rated current 5. Measurement : at ambient temperature 24 hours after test completion 	<ol style="list-style-type: none"> 1. No mechanical damage 2. Inductance value should be within $\pm 10\%$ of the initial value 3. Q vale should be within $\pm 20\%$ of the initial value
Resistance to Solder Heat	<ol style="list-style-type: none"> 1. Solder temperature : 260 \pm 5°C 2. Flux : Rosin 3. DIP time : 10 \pm 1 sec 	<ol style="list-style-type: none"> 1. More than 95 % of terminal electrode should be covered with new solder 2. Inductance value should be within $\pm 10\%$ of the initial value 3. Q vale should be within $\pm 20\%$ of the initial value
Solderability	<ol style="list-style-type: none"> 1. Solder temperature : 235 \pm 5°C 2. Flux : Rosin 3. DIP time : 5 \pm 1 sec 	<ol style="list-style-type: none"> 1. More than 95 % of terminal electrode should be covered with new solder 2. No mechanical damage
Bending Strength	<ol style="list-style-type: none"> 1. Solder the chip to test jig then apply a force in the direction shown in below. 2. The soldering shall be done with the reflow method and shall be conducted with care so that the soldering is uniform and free of defects such as heat shock. 	No mechanical damage

Packaging Specification

Leader and Trailer Tape

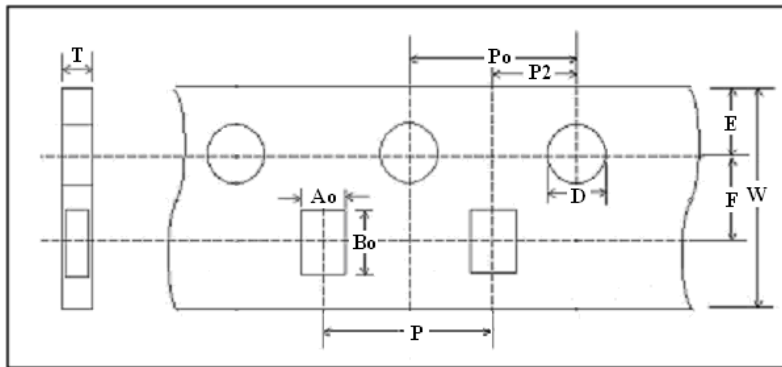
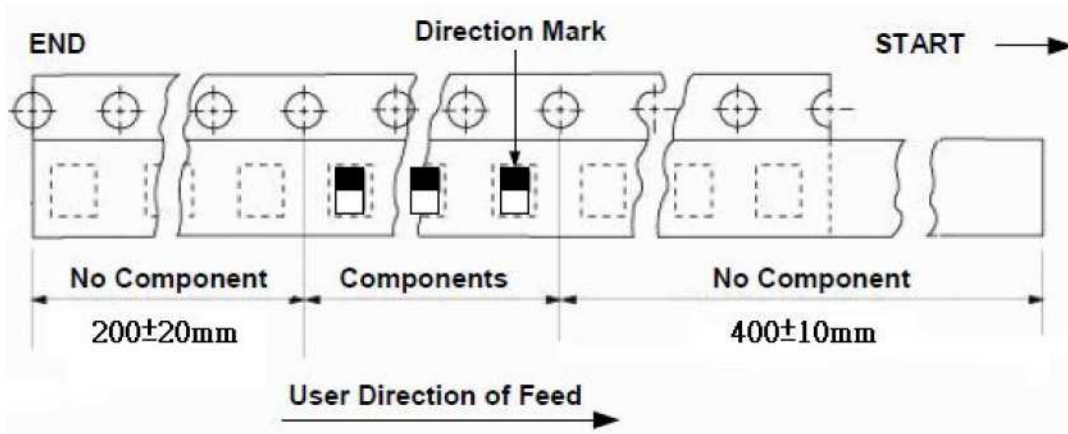

Taping Dimension

(mm)	0603	1005	1608
Symbol	PAPER	PAPER	PAPER
W	8.00 ± 0.10	8.00 ± 0.10	8.00 ± 0.10
P	2.00 ± 0.05	2.00 ± 0.05	4.00 ± 0.10
E	1.75 ± 0.05	1.75 ± 0.05	1.75 ± 0.05
F	3.50 ± 0.05	3.50 ± 0.05	3.50 ± 0.05
D	1.55 ± 0.05	1.55 ± 0.05	1.55 ± 0.05
P_0	4.00 ± 0.10	4.00 ± 0.10	4.00 ± 0.10
P_2	2.00 ± 0.05	2.00 ± 0.05	2.00 ± 0.05
A_0	0.36 ± 0.02	0.60 ± 0.03	0.98 ± 0.03
B_0	0.66 ± 0.02	1.12 ± 0.03	1.80 ± 0.05
T	0.42 ± 0.02	0.60 ± 0.03	0.95 ± 0.05

Packaging Specification
Reel

Unit : mm

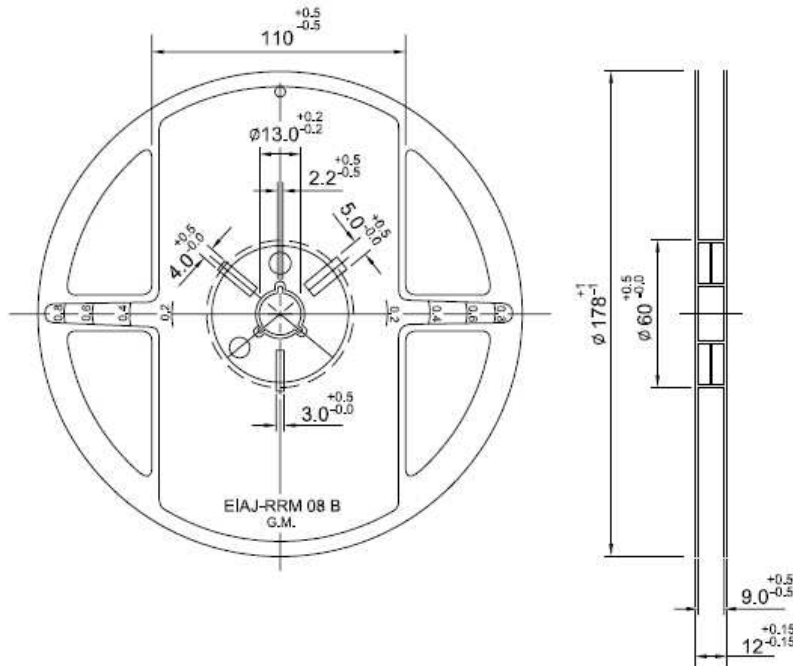

Quantity per reel

7" Reel Packaging Quantity			
PART SIZE (EIA SIZE)	0603 (0201)	1005 (0402)	1608 (0603)
Qty.(pcs)	15,000	10,000	4,000
BOX	5 reels / inner box		

RECOMMENDED SOLDERING CONDITIONS

