

Manual for the XXL/R/S product line



ComPoint-LAN-XXL



ComPoint-WLAN-XXR



AK-DinRail-XXL



AK-DinRail-XXR



EVA-Kits



XT-NANO-XXL/SXL



XT-PICO-XXL/SXL



XT-FEMTO-SXL

AK-Nord GmbH
Germany

Tel.: +49 (0) 5901 9389010
Fax:: +49 (0) 5901 9389024



AK-RailPort-XXR



AK-RailPort-XXL



XT-Micro-C-SXL



ConLine-V24-XXL/SXL



NetCon-SXL-USB

Contents

ConLine-V24-XXL	5
ConLine-V24-SXL	6
<i>Description of the RS232 – V24 interface</i>	7
ComPoint-LAN-XXL	8
<i>Description of the RS232 – V24 interface</i>	9
<i>Description of the board</i>	10
NetCon-SXL-USB	11
NetCon-SXL-USB	12
<i>Connection options:</i>	12
XT-MICRO-C-SXL	13
AK-DinRail-XXL	14
<i>Description and terminal assignment</i>	15
AK-RailPort-XXL	16
<i>Description and terminal assignment</i>	17
ComPoint-WLAN-XXR	18
<i>Description of the RS232 – V24 interface</i>	19
<i>Description of the board</i>	20
AK-DinRail-XXR	21
<i>Description and terminal assignment</i>	23
AK-RailPort-XXR	24
<i>Description and terminal assignment</i>	26
XT-PICO-XXL	27
XT-NANO-XXL	28
XT-FEMTO-SXL	29
XT-NANO-SXL	30
XT-PICO-SXL	31
EVA-KIT	32
<i>EVA-KIT XT-PICO-XXL</i>	32
<i>EVA-Kit XT-NANO-XXL</i>	33
TCP/IP network	34
<i>Port description</i>	37
<i>Description of the special ports:</i>	38
Emulations (operating modes)	39

Contents

Menu structure	41
Configuration with TELNET.....	48
<i>Configuring AK-XXL products</i>	<i>48</i>
ADMIN MENU.....	50
GENERAL MENU	51
NETWORK-MENU.....	53
ARP Menu.....	54
DHCP Menu.....	55
DNS Menu	56
DYNDNS Menu.....	58
FTP Menu	59
IP Menu.....	60
LPR Menu.....	61
NTP Menu.....	62
POP3 menu	63
SNMP Menu.....	64
SMTP Menu	65
TFTP Menu.....	66
TCP Menu.....	67
UDP Menu	69
DISK-DRIVE-MENU.....	71
VOLUME MENU	72
INTERFACE MENUConfiguration with TELNET	73
SERIAL Menu	74
SDCARD Menu.....	82
WIEGAND Menu.....	83
LPT Menu	84
Ethernet MENU.....	85
WLAN MENU.....	86
Configuration via the V24	94
<i>Configuration via the V24 (only serial versions).....</i>	<i>94</i>
XT-Admin.....	96
Description of XT-Admin	96
Description XT-Admin, SCAN	97
Description XT-Admin, Set IP	98
Description XT-Admin, Telnet.....	99
Description XT-Admin, Update.....	100
Description XT-Admin, File Transfer.....	101
Description XT-Admin-XXL, File transfer(FTP)	102

Contents

SSL / TLS	104
<i>SSL settings</i>	104
<i>SSL - Verify - Options</i>	106
<i>Other SSL settings</i>	107
<i>SSL/TLS in the server mode</i>	108
<i>SSL/TLS in the client mode</i>	112
Examples of applications	113
<i>ConnectOnData</i>	113
<i>TCPSERVER</i>	115
<i>UDPCLIENT</i>	117
<i>AutoConnect</i>	119
<i>MULTI-Connect</i>	121
<i>Tunnel emulation (cable replacement)</i>	123
<i>Modem emulation</i>	125
<i>E-mail-Emulation (Software)</i>	127
<i>E-mail-Emulation (Hardware)</i>	130
<i>E-mail receipt (POP3)</i>	133
<i>Exporting a configuration</i>	135
<i>Importing a configuration</i>	137
<i>DYNDNS</i>	138
<i>XT-NANO-XXL, COMPOINT-XXL, ComPoint-LAN -XXL</i>	139
Creating a homepage	142
Warranty	143

ConLine-V24-XXL

ConLine-V24-XXL



Technical description

Current consumption:	5 Volt / about 200 mA
Temperature range:	-40°C .. + 70°C
Network connections:	Ethernet 10/100MBit (MDIX) RJ45
Network speeds:	10/100 MBit Full/Half Duplex
Network protocols:	IPv4, IPv6, TCP, TCPv6, UDP, UDPv6, FTP, TFTP, ICMP, ICMPv6, ARP, NDP, SNMP, LPR, DHCP, DHCPv6, Netbios-NS, LLMNR, BOOTP, DNS, TELNET, HTML, DYNDNS, SMTP, POP3, SYSLOG, IEEE802.1x, ZeroConfig(AutoIP), IP-Multicast.
Connections:	1 x RS232 9-pole Sub-D plug or jack
Serial settings:	up to 1Mbaud, 7 or 8bits, Odd, Even, Mark, Space, None Parity
Signals:	TXD, RXD, RTS, CTS, DSR, DTR, DCD, RI, GND
Special features:	Modem Emulation, Connect-On-Data, Auto-Connect, Tunnel-Mode, DYNDNS-Client, FTP-Server, FTP-Client, LPR-Server, 20KB Flash drive, Flash-File-System, E-Mail – Client, TCP/UDP –Client, TCP/UDP –Server, SYSLOG-Client

ConLine-V24-SXL

ConLine-V24-SXL



Technical description

Current consumption:	5 Volt / about 200 mA
Temperature range:	-40°C .. + 70°C
Network connections:	Ethernet 10/100MBit (MDIX) RJ45
Network speeds:	10/100 MBit Full/Half Duplex
Network protocols:	IPv4, IPv6, TCP, TCPv6, UDP, UDPv6, FTP, TFTP, ICMP, ICMPv6, ARP, NDP, SNMP, LPR, DHCP, DHCPv6, Netbios-NS, LLMNR, BOOTP, DNS, TELNET, HTML, DYNDNS, SMTP, POP3, SYSLOG, IEEE802.1x, ZeroConfig(AutoIP), IP-Multicast, AKM2M, SSL3.0, TLS1.0, TLS1.1, TLS1.2.
Connections:	1 x RS232 9-pole Sub-D plug or jack
Serial settings:	up to 1Mbaud, 7 or 8bits, Odd, Even, Mark, Space, None Parity
Signals:	TXD, RXD, RTS, CTS, DSR, DTR, DCD, RI, GND
Special features:	Modem Emulation, Connect-On-Data, Auto-Connect, Tunnel-Mode, DYNDNS-Client, FTP-Server, FTP-Client, LPR-Server, 512KB Flash drive, Flash-File-System, E-Mail – Client, TCP/UDP –Client, TCP/UDP –Server, SYSLOG-Client, M2M

ConLine-V24-XXL/SXL

Description of the RS232 – V24 interface

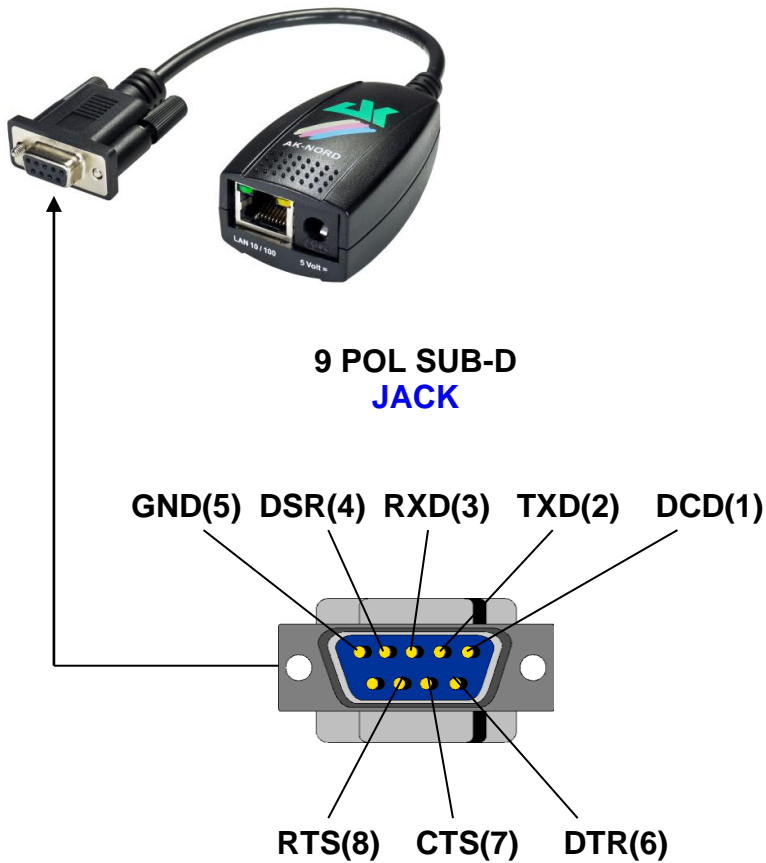
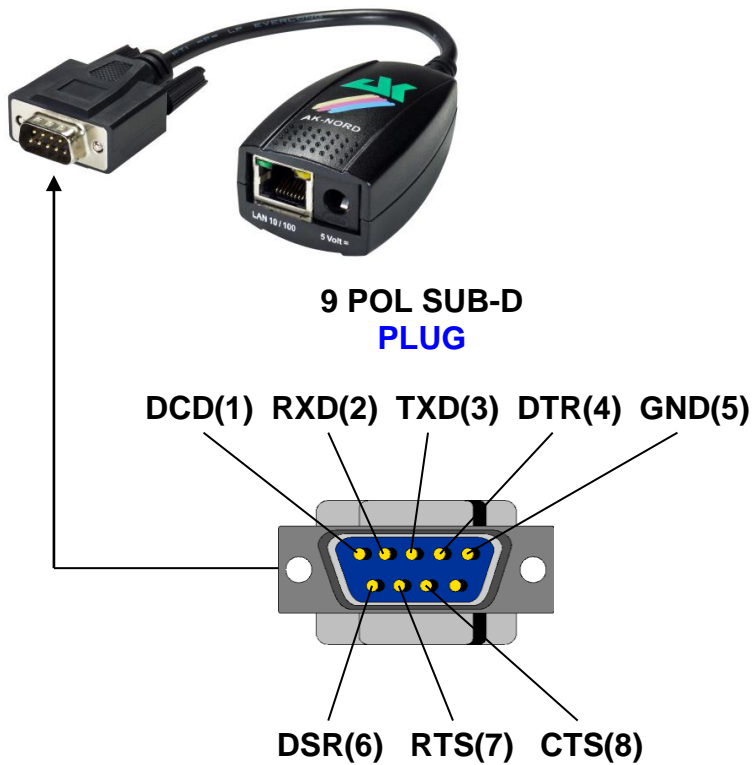

ComPoint-LAN-XXL

ComPoint-LAN-XXL



Technical description

Dimensions:	100 x 28 x 110 mm (WxHxL)
Temperature range:	-40°C .. + 70°C
Current consumption:	5-6Volt / about 270 mA
Network connections:	Ethernet 10/100MBit (MDIX) RJ45 (optional with PoE)
Network speeds:	10/100 MBit Full/Half Duplex
Network protocols:	IPv4, IPv6, TCP, TCPv6, UDP, UDPv6, FTP, TFTP, ICMP, ICMPv6, ARP, NDP, SNMP, LPR, DHCP, DHCPv6, Netbios-NS, LLMNR, BOOTP, DNS, TELNET, HTML, DYNDNS, SMTP, POP3, SYSLOG, IEEE802.1x, ZeroConfig(AutoIP), IP-Multicast.
Connections:	2 x RS232 / RS485 9-pole Sub-D plug, SD card
Serial settings:	up to 1Mbaud, 7 or 8bits, Odd, Even, Mark, Space, None Parity
Signals:	TXD, RXD, RTS, CTS, DSR, DTR, DCD, RI, GND
Special features:	Modem Emulation, Connect-On-Data, Auto-Connect, Tunnel-Mode, DYNDNS-Client, FTP-Server, FTP-Client, LPR-Server, 20KB Flash drive, Flash-File-System, SD- and DF-CARD, E-Mail – Client, TCP/UDP –Client, TCP/UDP –Server, SYSLOG-Client

ComPoint-LAN-XXL

Description of the RS232 – V24 interface

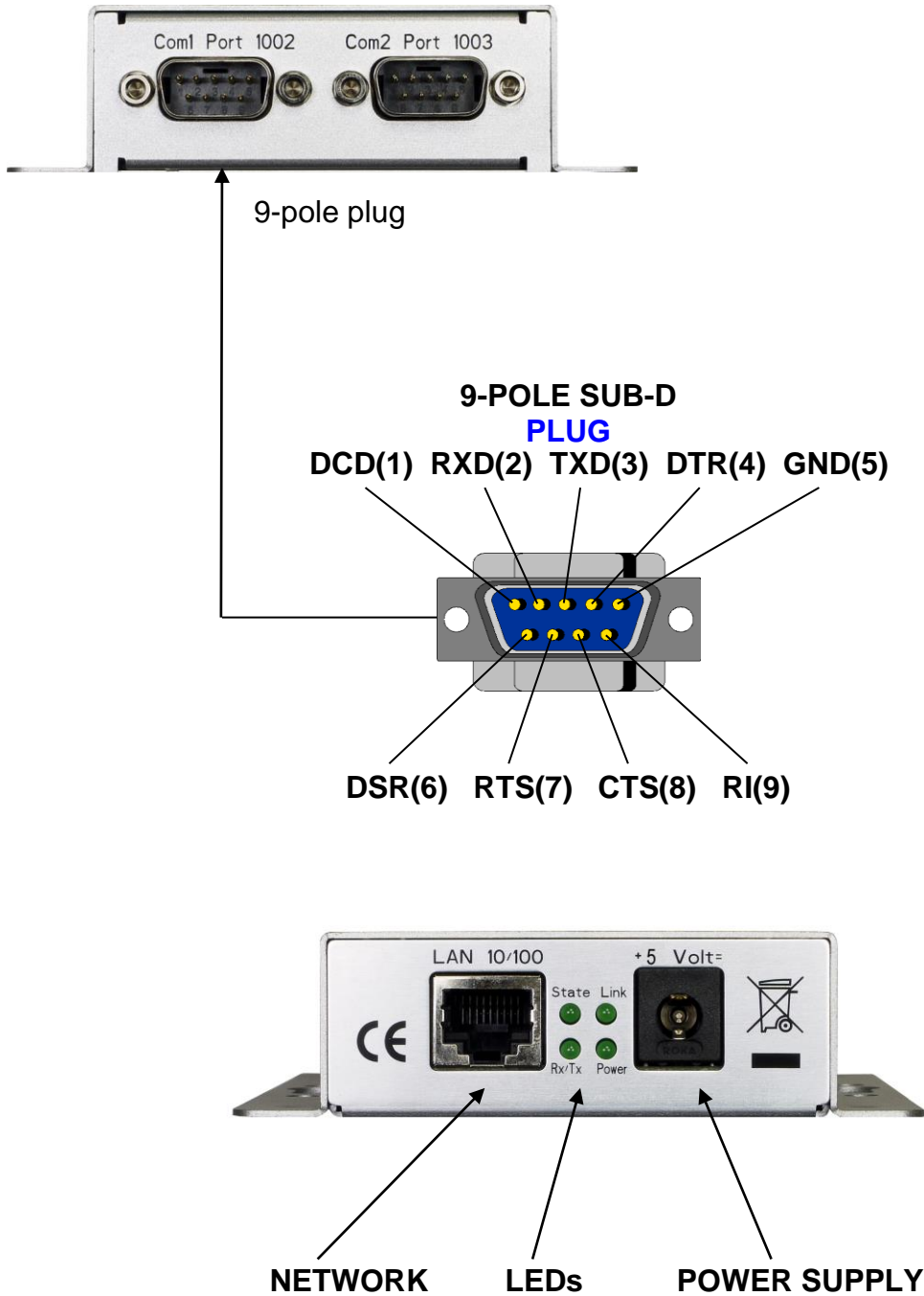

LEDs (view from the front)

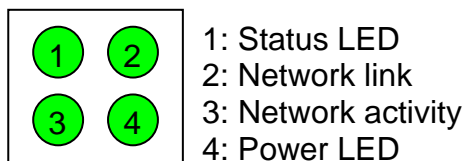

ComPoint-LAN-XXL

Description of the board

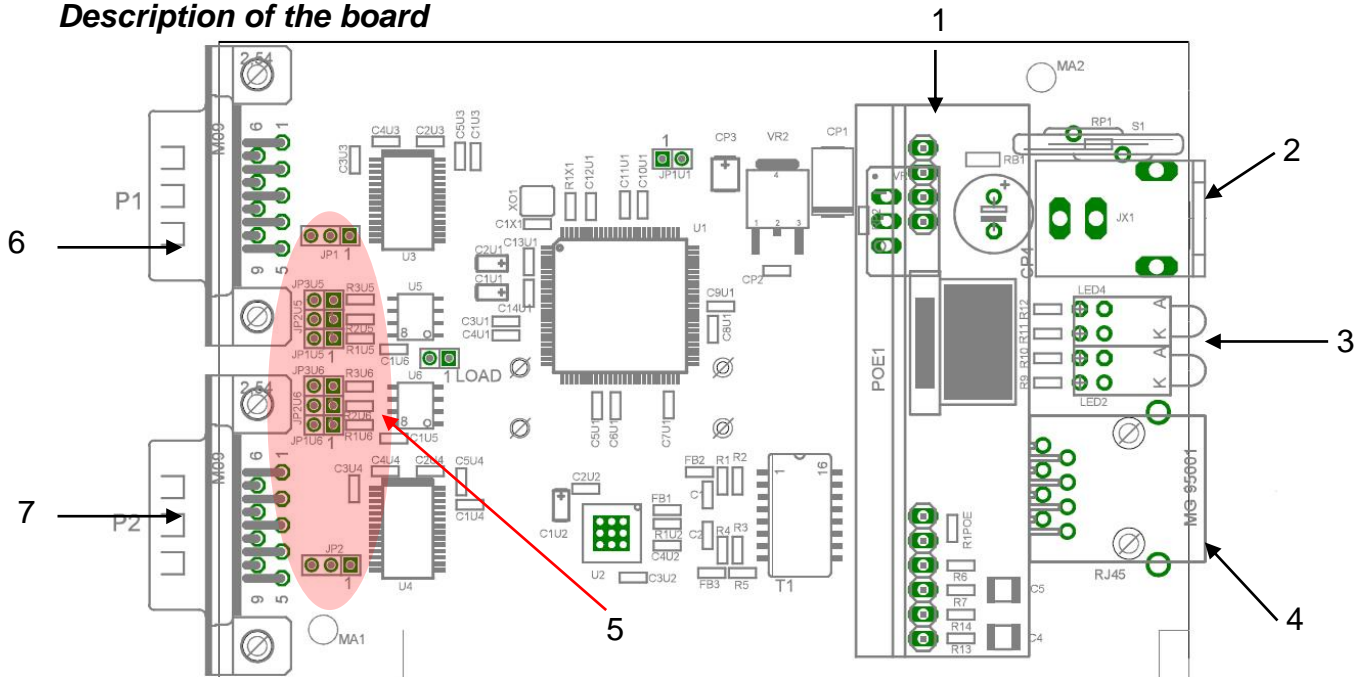

1	Extension slot (PowerOverEthernet)
2	Power supply
3	LEDs
4	RJ45 jack (Lan)
5	Jumperblocks for COM1 / COM2)
6	COM1
7	COM2

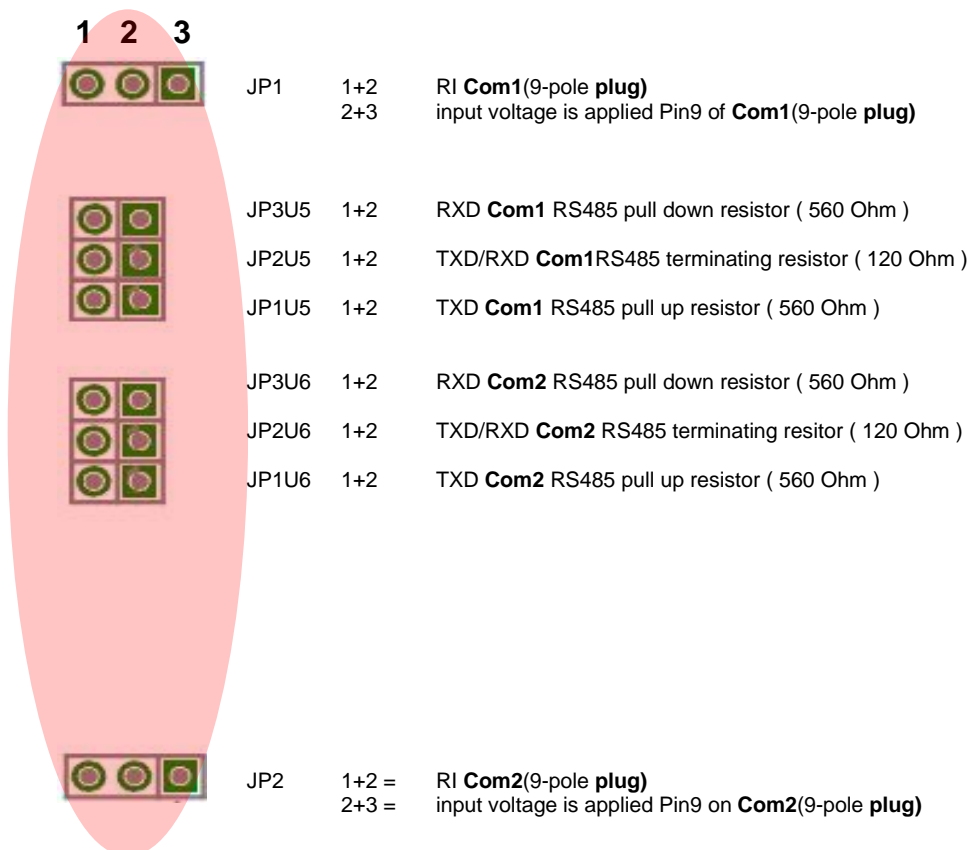

NetCon-SXL-USB

NetCon-SXL-USB



Front with power supply connector



Front with PowerOverEthernet



Rear side with USB connector

Technical description

Dimensions:	40 x 21 x 82 mm (WxHxL)
Temperature range:	-40°C .. + 85°C
Weight:	37 Gramms
Power supply:	Switching power supply 5Volt, 2A (NetCon-SXL-USB-NT) PowerOverEthernet IEEE802.3af (NetCon-SXL-USB-POE)
Current consumption:	5 Volts / ca. 200 mA
Network connections:	1 x Ethernet 10/100MBit (MDIX) RJ45
Network speeds:	10/100 MBit Full/Half Duplex
Network protocols:	IPv4, IPv6, TCP, TCPv6, UDP, UDPv6, FTP, TFTP, ICMP, ICMPv6, ARP, NDP, SNMP, LPR, DHCP, DHCPv6, Netbios-NS, LLMNR, BOOTP, DNS, TELNET, HTML, DYNDNS, SMTP, POP3, SYSLOG, IEEE802.1x, ZeroConfig(AutoIP), IP-Multicast, AKM2M, SSL3.0, TLS1.0, TLS1.1, TLS1.2.
Connections:	1 x USB-A Jack (USB1.0, USB1.1, USB2.0)
Connection - Functions:	Host Mode Class 03 HID Class 07 Printer Class 09 Hub
Special features:	Connect-On-Data, Auto-Connect, DYNDNS-Client, FTP-Server, LPR-Server, 512KB Flashdrive, Flash-File-System, E-Mail-Client, TCP/UDP-Client, TCP/UDP-Server, SYSLOG-Client, AKM2M

NetCon-SXL-USB

Connection options:

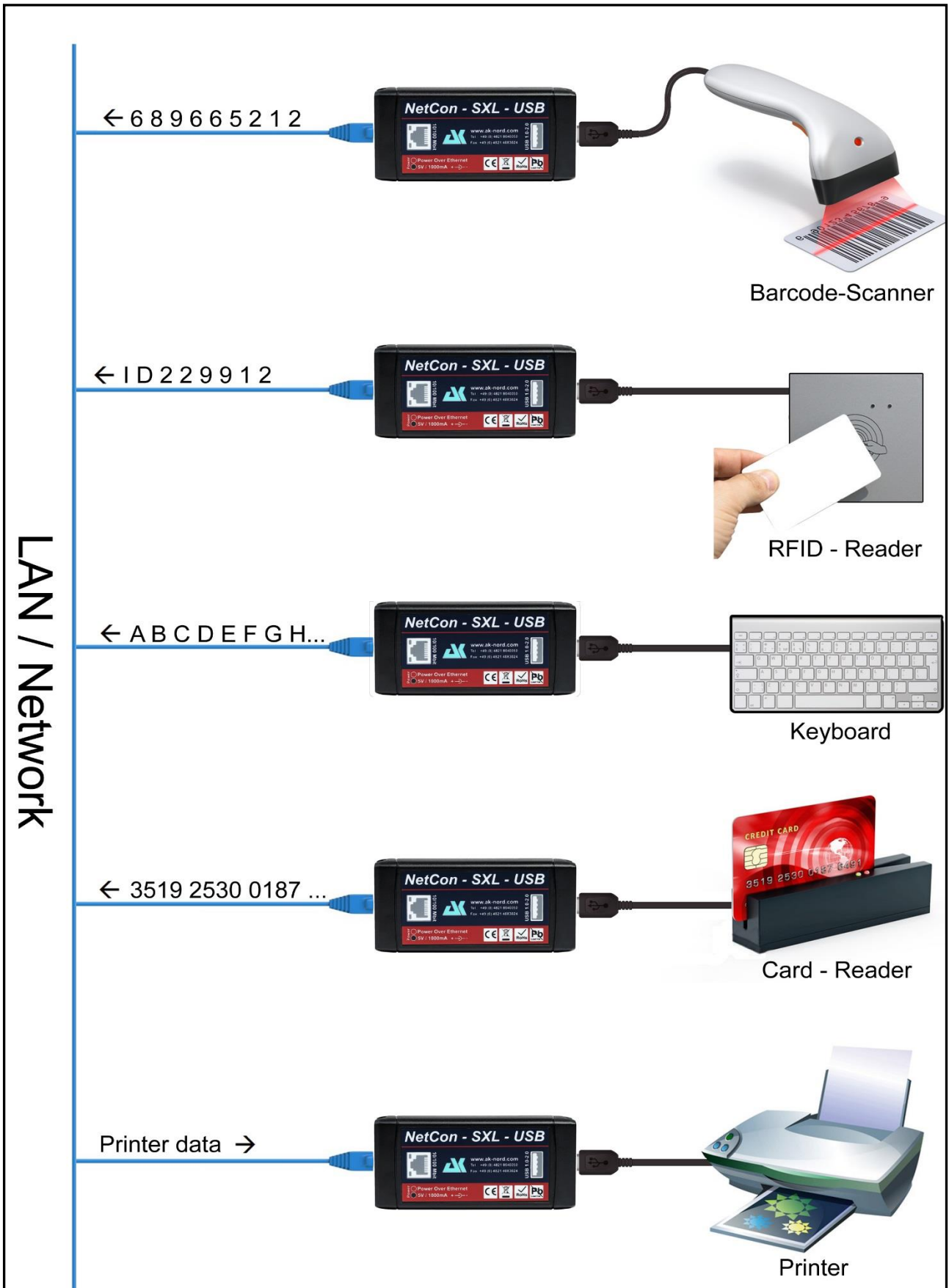

XT-MICRO-C-SXL

XT-MICRO-C-SXL



Technical description

Current consumption:	5 Volts / ca. 200 mA
Temperature range:	-40°C .. + 70°C
Connections:	1 x 36 Pol Centronics Stecker IEEE 1284
Network connections:	Ethernet 10/100MBit (MDIX) RJ45
Network speeds:	10/100 MBit Full/Half Duplex
Network protocols:	IPv4, IPv6, TCP, TCPv6, UDP, UDPv6, FTP, TFTP, ICMP, ICMPv6, ARP, NDP, SNMP, LPR, DHCP, DHCPv6, Netbios-NS, LLMNR, BOOTP, DNS, TELNET, HTML, DYNDNS, SMTP, POP3, SYSLOG, IEEE802.1x, ZeroConfig(AutoIP), IP-Multicast, AKM2M, SSL3.0, TLS1.0, TLS1.1, TLS1.2.
Special features:	Power supply via pin 18 of the printer possible

AK-DinRail-XXL

AK-DinRail-XXL



Technical description

Dimensions:	22.5 x 120 mm(WxH)
Temperature range:	-40°C .. + 70°C
Current consumption:	7-32 volts / 0,96 watt
Network connections:	Ethernet 10/100MBit (MDIX) RJ45
Network speeds:	10/100 MBit Full/Half Duplex
Network protocols:	IPv4, IPv6, TCP, TCPv6, UDP, UDPv6, FTP, TFTP, ICMP, ICMPv6, ARP, NDP, SNMP, LPR, DHCP, DHCPv6, Netbios-NS, LLMNR, BOOTP, DNS, TELNET, HTML, DYNDNS, SMTP, POP3, SYSLOG, IEEE802.1x, ZeroConfig(AutoIP), IP-Multicast.
Connections:	2 x RS232 9 Pole Sub-D Plug 2 x RS485 1 x Power supply 1 x SD-Card Holder
Serial settings:	up to 1Mbaud, 7 or 8bits, Odd, Even, Mark, Space, None Parity
Signals:	TXD, RXD, RTS, CTS, DSR, DTR, DCD, RI, GND
Special features:	Modem Emulation, Connect-On-Data, Auto-Connect, Tunnel-Mode, DYNDNS-Client, FTP-Server, FTP-Client, LPR-Server, 20KB Flash drive, Flash-File-System, SD- and DF-CARD, E-Mail – Client, TCP/UDP –Client, TCP/UDP –Server, SYSLOG-Client

AK-DinRail-XXL

Description and terminal assignment



← RS232 interface 2
Port 1003

← RS232 interface 1
Port 1002



← Network

← RS485 connection 2
Port 1003

← RS485 connection 1
Port 1002

← Power supply



← SD card holder

← LED

← DIP switch RS485
Termination, Pullup, Pulldown

RS232 connections

DCD(1) RXD(2) TXD(3) DTR(4) GND(5)

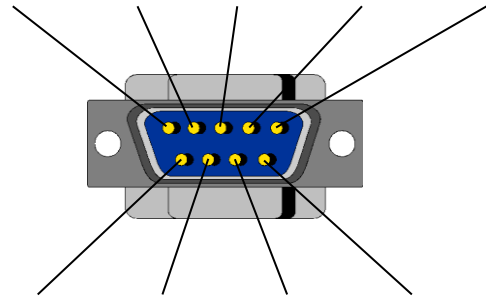

DSR(6) RTS(7) CTS(8) RI(9)

RS485 connections

Ground / GND	
RS485+ / RS485-A	
RS485- / RS485-B	

Power supply

Shield	
+ 7-32 VDC 0,96 watt	
- 7-32 VDC 0,96 watt	

- Power LED
- Network link
- Network activity
- Status LED

AK-RailPort-XXL

AK-RailPort-XXL



Technical description

Dimensions:	87 x 62 mm(WxH)
Temperature range:	-40°C .. + 70°C
Current consumption:	7-32 volts / 0,96 watt
Network connections:	Ethernet 10/100MBit (MDIX) RJ45
Network speeds:	10/100 MBit Full/Half Duplex
Network protocols:	IPv4, IPv6, TCP, TCPv6, UDP, UDPv6, FTP, TFTP, ICMP, ICMPv6, ARP, NDP, SNMP, LPR, DHCP, DHCPv6, Netbios-NS, LLMNR, BOOTP, DNS, TELNET, HTML, DYNDNS, SMTP, POP3, SYSLOG, IEEE802.1x, ZeroConfig(AutoIP), IP-Multicast.
Connections:	2 x RS232 9 Pole Sub-D Plug 2 x RS485 1 x Power supply 1 x SD-Card Holder
Serial settings:	up to 1Mbaud, 7 or 8bits, Odd, Even, Mark, Space, None Parity
Signals:	TXD, RXD, RTS, CTS, DSR, DTR, DCD, RI, GND
Special features:	Modem Emulation, Connect-On-Data, Auto-Connect, Tunnel-Mode, DYNDNS-Client, FTP-Server, FTP-Client, LPR-Server, 20KB Flash drive, Flash-File-System, SD- and DF-CARD, E-Mail – Client, TCP/UDP –Client, TCP/UDP –Server, SYSLOG-Client

AK-RailPort-XXL

Description and terminal assignment



RS232 interface 1
Port 1002

RS232 interface 2
Port 1003

RS232 connections

DCD(1) RXD(2) TXD(3) DTR(4) GND(5)

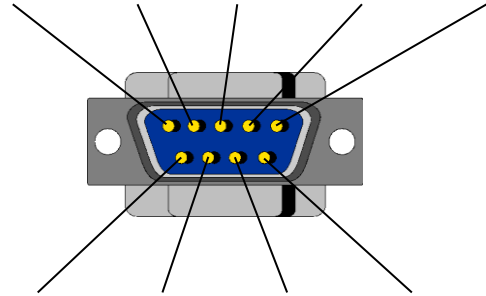

DSR(6) RTS(7) CTS(8) RI(9)

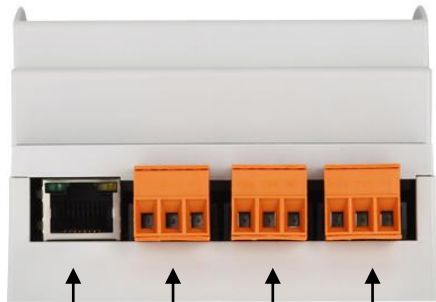

Network

RS485 connection 2
Port 1003

RS485 connection 1
Port 1002

Power supply

RS485 connections

Ground / GND	
RS485+ / RS485-A	
RS485- / RS485-B	

Power supply

Shield	
+ 7-32 VDC 0,96 watt	
- 7-32 VDC 0,96 watt	



SD card holder

DIP switch RS485
Termination, Pullup, Pulldown

- Power LED
- Network link
- Network activity
- Status LED

ComPoint-WLAN-XXR

ComPoint-WLAN-XXR



Technical description

Dimensions:	100 x 28 x 110 mm (WxHxL)
Temperature range:	-40°C .. + 70°C
Current consumption:	5-6Volt / ca. 380 mA
Wireless LAN (WLAN)	Features ADHOC / INFRA – Modus Fast-Roaming AutoConnection with Wi-Fi Protected Setup (WPS-PBC) Hardware WEP, TKIP, AES Engine WEP 64Bit and 128Bit up to 4 Keys IEEE802.11b: 1, 2, 5.5, 11Mbps IEEE802.11g: 6, 9, 12, 24, 36, 48, 54Mbps IEEE802.11n: (Draft 3.0) up to 150Mbps legacy, mixed and green field modes, supports 20/40 MHz band width MCS0- 7 (150Mbps PHY rate support) IEEE802.11d: World Mode (US, CA, EU, JP) IEEE802.11e: Wi-Fi WMM-QoS "Quality of Service" Wi-Fi WMM-PS "Power Save" IEEE802.11h: DFS (Dynamic Frequency Selection) TPC (Transmission Power Control) IEEE802.11i: WPA1 and WPA2 Personal. IEEE802.11j: Operation in Japan
Network connections:	Ethernet 10/100MBit (MDIX) RJ45
Network speeds:	10/100 MBit Full/Half Duplex
Network protocols:	IPv4, IPv6, TCP, TCPv6, UDP, UDPv6, FTP, TFTP, ICMP, ICMPv6, ARP, NDP, SNMP, LPR, DHCP, DHCPv6, Netbios-NS, LLMNR, BOOTP, DNS, TELNET, HTML, IEEE802.1x, DYNDNS, SMTP, POP3, SYSLOG, ZeroConfig(AutoIP), IP-Multicast.
Connections:	2 x RS232 / RS485 9-pole Sub-D plug, SD card
Serial settings:	up to 230Kbaud, 7 or 8bits, Odd, Even, Mark, Space, None Parity
Signals:	TXD, RXD, RTS, CTS, DSR, DTR, DCD, RI, GND
Special features:	Modem Emulation, Connect-On-Data, Auto-Connect, Tunnel-Mode, DYNDNS-Client, FTP-Server, FTP-Client, LPR-Server, 2MB Flash drive, Flash-File-System, SD- and DF-CARD, E-Mail – Client, TCP/UDP –Client, TCP/UDP –Server, SYSLOG-Client:

ComPoint-WLAN-XXR

Description of the RS232 – V24 interface



9 pole plug

**9 POLE SUB-D
PLUG**
DCD(1) RXD(2) TXD(3) DTR(4) GND(5)

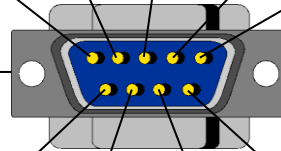

DSR(6) RTS(7) CTS(8) RI(9)

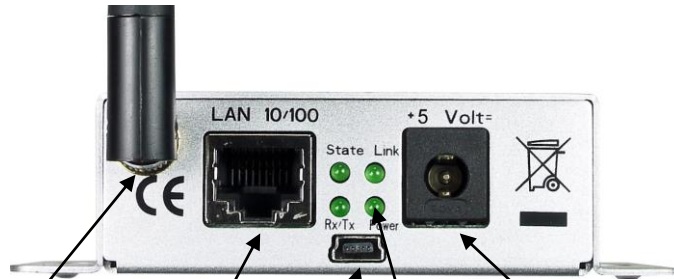

ANTENNA NETWORK USB LEDs POWER SUPPLY

LEDs (view from the front)

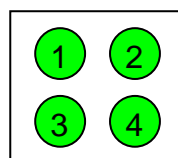

1: Status LED
2: Network link
3: Network activity
4: Power LED

ComPoint-WLAN-XXR

Description of the board

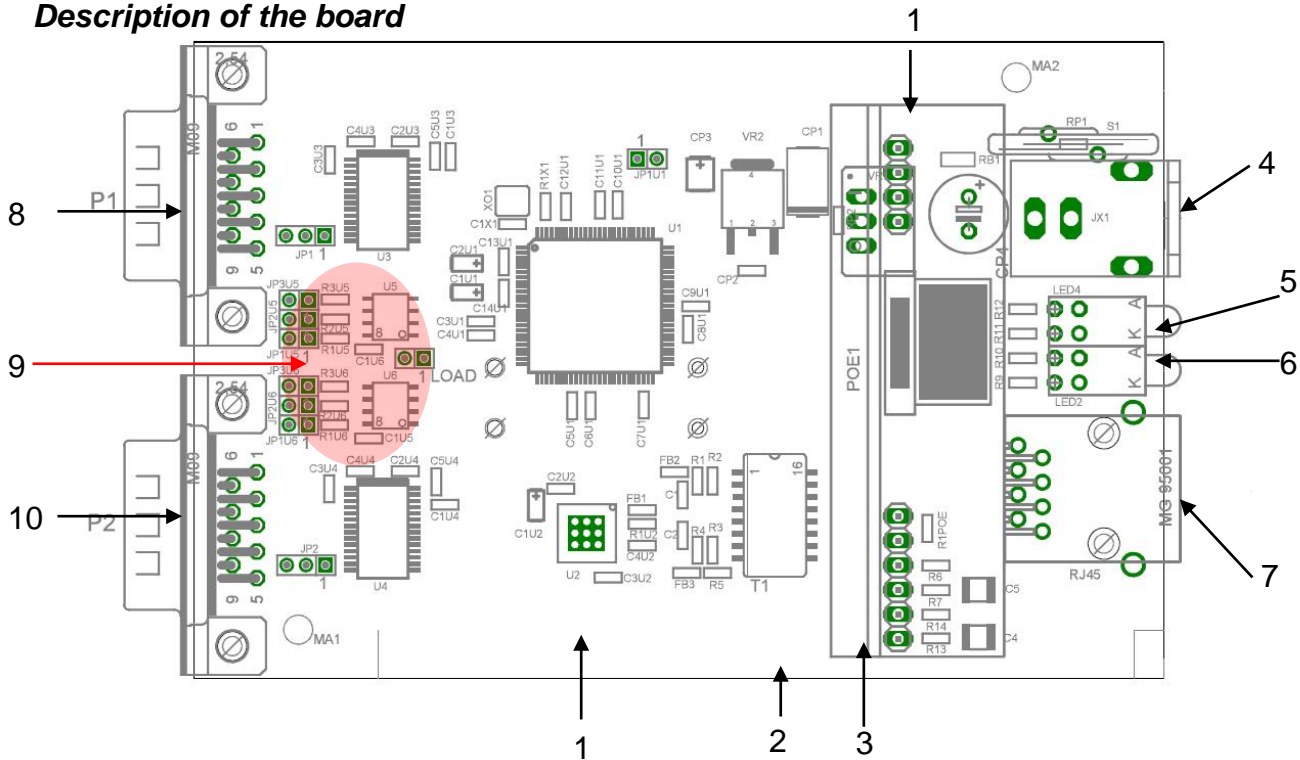

1	WLAN Extension slot
2	MicroSD-Card holder (bottom side)
3	PowerOverEthernet Extension slot
4	Power supply
5	LEDs
6	USB Configuration connector (bottom side)
7	RJ45 Configuration connector (Ethernet)
8	COM1
9	Jumperblocks for COM2 (JP2 and JP1U6-JP3U6)
10	COM2

1 2 3



JP1	1+2 2+3	RI Com1 (9-pole plug) input voltage is applied Pin9 on Com1 (9-pole plug)
JP2	1+2	TXD Com1 RS485 pull up - resistor (560 Ohm)
JP3	1+2	TXD/RXD Com1 RS485 terminating resistor (120 Ohm)
JP4	1+2	RXD Com1 RS485 pull down resistor (560 Ohm)
JP5	1+2	TXD Com2 RS485 pull up - resistor (560 Ohm)
JP6	1+2	TXD/RXD Com2 RS485 terminating resistor (120 Ohm)
JP7	1+2	RXD Com2 RS485 pull down - resistor (560 Ohm)
JP8	1+2 2+3	RI Com2 (9-pole plug) input voltage is applied Pin9 on Com2 (9-pole plug)

AK-DinRail-XXR

AK-DinRail-XXR



Technical description

Dimensions: 35 x 120 mm(WxH)

Temperature range: -40°C .. + 70°C

Current consumption: 7-32 volts / 2,2 watt

Wireless LAN (WLAN)

Features **ADHOC / INFRA – Modus**
Fast-Roaming
AutoConnection with Wi-Fi Protected Setup (WPS-PBC)
Hardware **WEP, TKIP, AES** Engine
WEP 64Bit and 128Bit up to 4 Keys

IEEE802.11b: 1, 2, 5.5, 11Mbps
IEEE802.11g: 6, 9, 12, 24, 36, 48, 54Mbps
IEEE802.11n: (Draft 3.0) up to 150Mbps
legacy, mixed and green field modes, supports 20/40
MHz band width MCS0- 7 (150Mbps PHY rate support)

IEEE802.11d: World Mode (US, CA, EU, JP)
IEEE802.11e: Wi-Fi WMM-QoS "Quality of Service"
Wi-Fi WMM-PS "Power Save"
IEEE802.11h: DFS (Dynamic Frequency Selection)
TPC (Transmission Power Control)
IEEE802.11i: WPA1 and WPA2 Personal.
IEEE802.11j: Operation in Japan

Network connections: Ethernet 10/100MBit (**MDIX**) RJ45

Network speeds: 10/100 MBit Full/Half Duplex

Network protocols: IPv4, IPv6, TCP, TCPv6, UDP, UDPv6, FTP, TFTP, ICMP, ICMPv6, ARP, NDP, SNMP, LPR, DHCP, DHCPv6, Netbios-NS, LLMNR, BOOTP, DNS, TELNET, HTML, DYNDNS, SMTP, POP3, SYSLOG, ZeroConfig(AutoIP), IEEE802.1x, IP-Multicast.

AK-DinRail-XXR

Connections:	2 x RS232 9 Pole Sub-D Plug 2 x RS485 1 x Power supply 1 x SD-Card Holder
Serial settings:	up to 230Kbaud, 7 or 8bits, Odd, Even, Mark, Space, None Parity
Signals:	RS232 = TXD, RXD, RTS, CTS, DSR, DTR, DCD, RI, GND RS485 = TXD, RXD, GND
Special features:	Modem Emulation, Connect-On-Data, Auto-Connect, Tunnel-Mode, DYNDNS-Client, FTP-Server, FTP-Client, LPR-Server, 2MB Flash drive, Flash-File-System, SD- and DF-CARD, E-Mail – Client, TCP/UDP –Client, TCP/UDP – IEEE802.1x, Server, SYSLOG-Client:

AK-DinRail-XXR

Description and terminal assignment

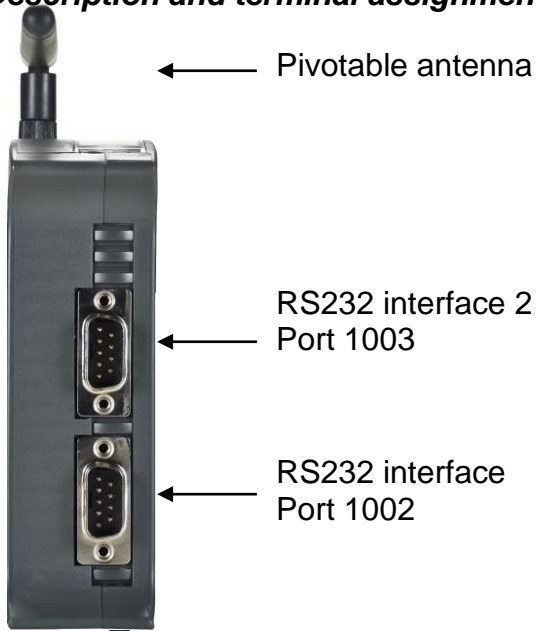

← Pivorable antenna

← RS232 interface 2
Port 1003

← RS232 interface
Port 1002

RS232 connections

DCD(1) RXD(2) TXD(3) DTR(4) GND(5)

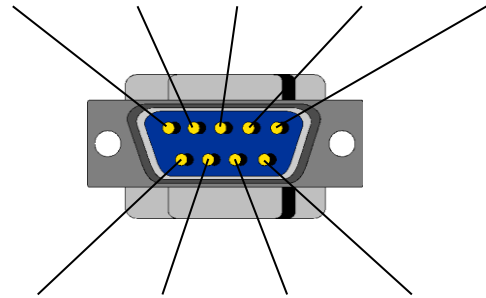

DSR(6) RTS(7) CTS(8) RI(9)

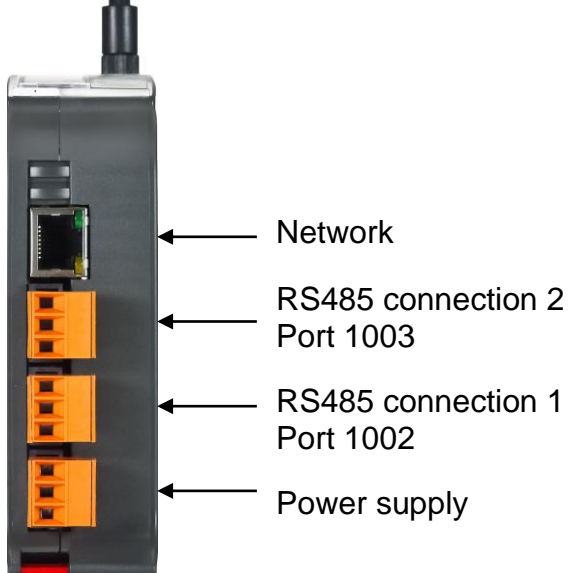

← Network

← RS485 connection 2
Port 1003

← RS485 connection 1
Port 1002

← Power supply

RS485 connections

Ground / GND	
RS485+ / RS485-A	
RS485- / RS485-B	

Power supply

Shield	
+ 7-32 VDC 2,2 watt	
- 7-32 VDC 2,2 watt	

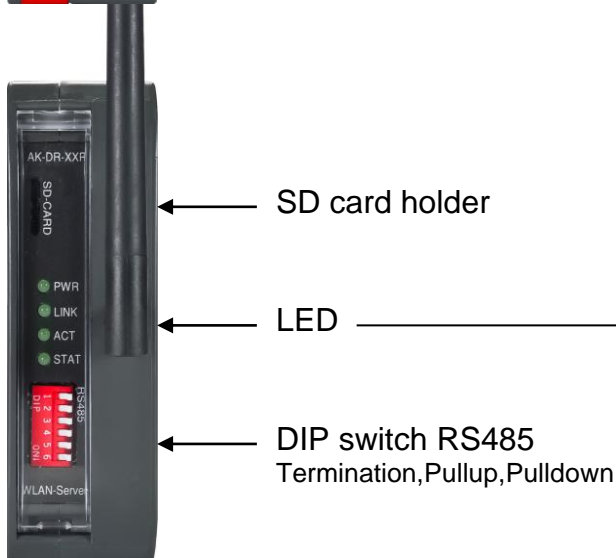

← SD card holder

← LED

← DIP switch RS485
Termination, Pullup, Pulldown

- Power LED
- Network link
- Network activity
- Status LED

AK-RailPort-XXR

AK-RailPort-XXR



Technical description

Dimensions: 87 x 62 mm(WxH)

Temperature range: -40°C .. + 70°C

Current consumption: 7-32 volts / 2,2 watt

Wireless LAN (WLAN)

Features

ADHOC / INFRA – Modus

Fast-Roaming

AutoConnection with Wi-Fi Protected Setup (WPS-PBC)

Hardware **WEP, TKIP, AES** Engine

WEP 64Bit and 128Bit up to 4 Keys

IEEE802.11b: 1, 2, 5.5, 11Mbps

IEEE802.11g: 6, 9, 12, 24, 36, 48, 54Mbps

IEEE802.11n: (Draft 3.0) up to 150Mbps

legacy, mixed and green field modes, supports 20/40

MHz band width MCS0- 7 (150Mbps PHY rate support)

IEEE802.11d: World Mode (US, CA, EU, JP)

IEEE802.11e: Wi-Fi WMM-QoS "Quality of Service"

Wi-Fi WMM-PS "Power Save"

IEEE802.11h: DFS (Dynamic Frequency Selection)

TPC (Transmission Power Control)

IEEE802.11i: WPA1 and WPA2 Personal.

IEEE802.11j: Operation in Japan

Network connections: Ethernet 10/100MBit (**MDIX**) RJ45

Network speeds: 10/100 MBit Full/Half Duplex

Network protocols:

IPv4, IPv6, TCP, TCPv6, UDP, UDPv6, FTP, TFTP, ICMP, ICMPv6, ARP, NDP, SNMP, LPR, DHCP, DHCPv6, Netbios-NS, LLMNR, BOOTP, DNS, TELNET, HTML, DYNDNS, SMTP, POP3, SYSLOG, ZeroConfig(AutoIP), IEEE802.1x, IP-Multicast.

AK-RailPort-XXR

Connections:	2 x RS232 9 Pole Sub-D Plug 2 x RS485 1 x Power supply 1 x SD-Card Holder
Serial settings:	up to 230Kbaud, 7 or 8bits, Odd, Even, Mark, Space, None Parity
Signals:	RS232 = TXD, RXD, RTS, CTS, DSR, DTR, DCD, RI, GND RS485 = TXD, RXD, GND
Special features:	Modem Emulation, Connect-On-Data, Auto-Connect, Tunnel-Mode, DYNDNS-Client, FTP-Server, FTP-Client, LPR-Server, 2MB Flash drive, Flash-File-System, SD- and DF-CARD, E-Mail – Client, TCP/UDP –Client, TCP/UDP –Server, SYSLOG-Client:

AK-RailPort-XXR

Description and terminal assignment

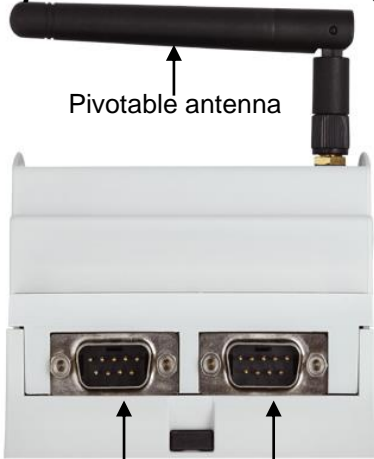

Pivorable antenna

RS232 interface 1
Port 1002

RS232 interface 2
Port 1003

RS232 connections

DCD(1) RXD(2) TXD(3) DTR(4) GND(5)

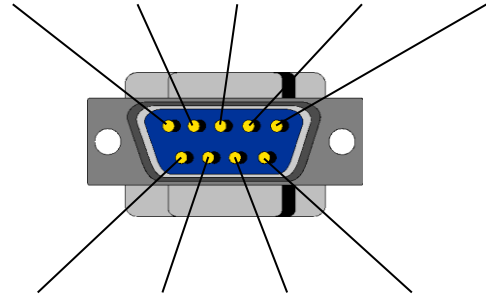

DSR(6) RTS(7) CTS(8) RI(9)

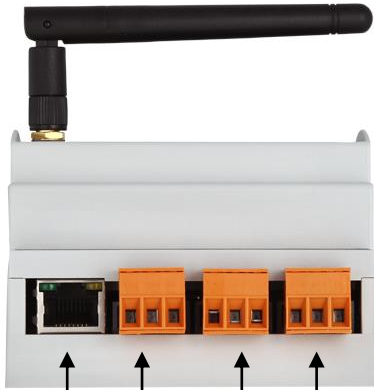

Network

RS485 connection 2
Port 1003

Power supply

RS485 connection 1
Port 1002

RS485 connections

Ground / GND	
RS485+ / RS485-A	
RS485- /	

Power supply

Shield	
+ 7-32 VDC 2,2 watt	
- 7-32 VDC 2,2 watt	



SD card holder

DIP switch RS485
Termination, Pullup, Pulldown

- ① Power LED
- ② Network link
- ③ Network activity
- ④ Status LED

XT-PICO-XXL

XT - PICO – XXL

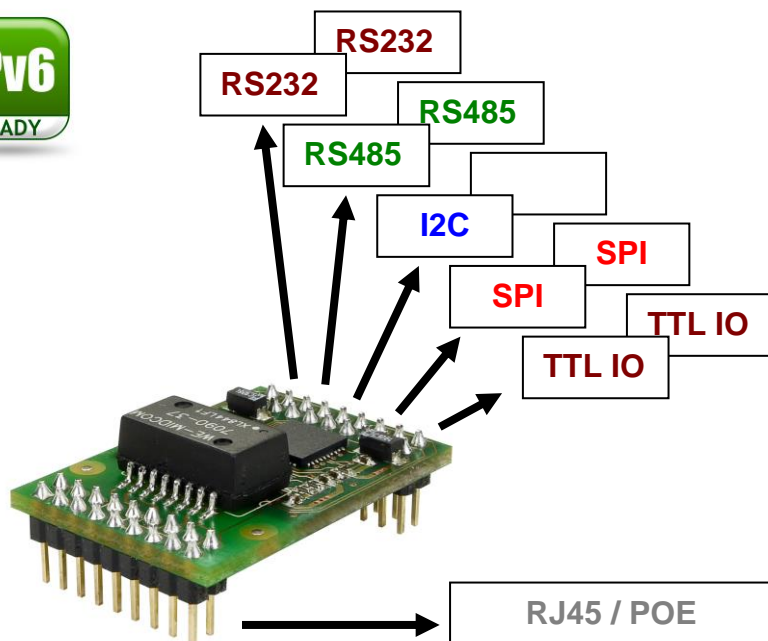

Technical description

Dimensions:	32 x 22 mm
Temperature range:	-40°C .. +85°C
Current consumption:	3.3 Volt / ca. 170 mA
Network connections:	Ethernet 10/100MBit (MDIX) RJ45 (PoE pins executed)
Network speeds:	10/100 MBit Full/Half Duplex
Network protocols:	IPv4, IPv6, TCP, TCPv6, UDP, UDPv6, FTP, TFTP ,ICMP, ICMPv6, ARP, NDP, SNMP, LPR, DHCP, DHCPv6, Netbios-NS, LLMNR, BOOTP, DNS, TELNET, HTML, DYNDNS, SMTP, POP3, SYSLOG, IEEE802.1x, ZeroConfig(AutoIP), IP-Multicast, AKM2M
Connections:	2 x Bus TTL-Level(3.3V)
Available interfaces:	2 x RS232 , 2 x RS485 , 1 x I2C , 2 x SPI or 2 x TTL-IO
Special features:	Modem Emulation, Connect-On-Data, Auto-Connect, Tunnel-Mode, DYNDNS-Client, FTP-Server, FTP-Client, LPR-Server, I2C – Master , SPI – Master / Slave, TTL – IO, 20KB flash drive, Flash-File-System, SD- and DF-CARD, 4bit- and SPI – DISPLAY, E-Mail – Client, TCP/UDP –Client, TCP/UDP –Server, SYSLOG-Client, M2M



Note:

This is only a short overview about the available information of the XT- PICO -XXL. Please find further information in the in the DesignGuide of the XT-PICO-XXL.

http://www.ak-nord.de/en/daten/design_xtpico_xxl_en.pdf

XT-NANO-XXL

XT-NANO-XXL

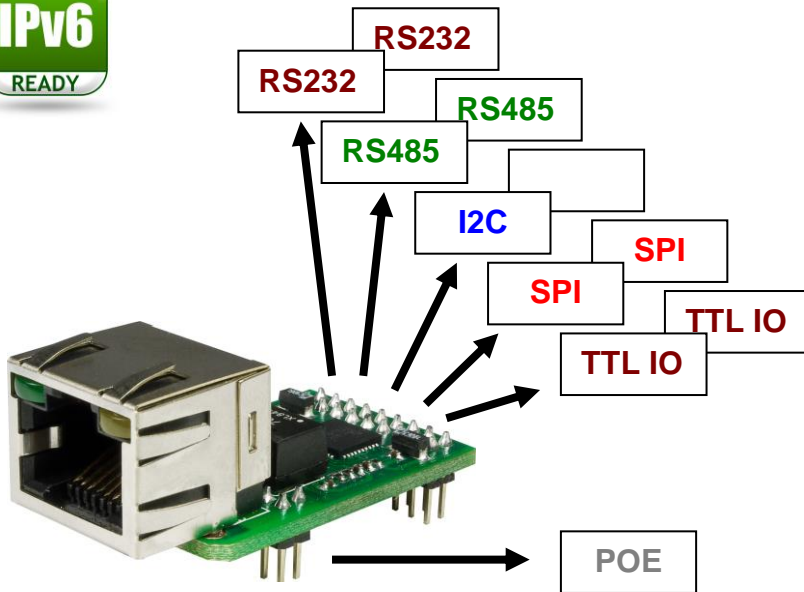

Technical description

Dimensions:	34 x 20 mm
Temperature range:	-40°C .. +85°C
Current consumption:	3.3Volt / about 170 mA
Network connections:	Ethernet 10/100Mbit (MDIX) RJ45 (PoE pins executed)
Network speeds:	10/100 MBit Full/Half Duplex
Network protocols:	IPv4, IPv6, TCP, TCPv6, UDP, UDPv6, FTP, TFTP ,ICMP, ICMPv6, ARP, NDP, SNMP, LPR, DHCP, DHCPv6, Netbios-NS, LLMNR, BOOTP, DNS, TELNET, HTML, DYNDNS, SMTP, POP3, SYSLOG, IEEE802.1x, ZeroConfig(AutoIP), IP-Multicast, AKM2M
Connections:	2 x Bus TTL-Level(3.3V)
Available interfaces:	2 x RS232 , 2 x RS485, 1 x I2C , 2 x SPI or 2 x TTL-IO
Special functions:	Modem Emulation, Connect-On-Data, Auto-Connect, Tunnel-Mode, DYNDNS-Client, FTP-Server, FTP-Client, LPR-Server, I2C – Master , SPI – Master / Slave, TTL – IO, 20KB flash drive , Flash-File-System, SD- and DF-CARD, 4bit- and SPI – DISPLAY, E-Mail – Client, TCP/UDP –Client, TCP/UDP –Server, SYSLOG-Client, M2M



Note:

This is only a short overview about the available information of the XT- NANO-XXL. Please find further information in the in the DesignGuide of the XT-NANO-XXL.

http://www.ak-nord.de/en/daten/design_xtnano_xxl_en.pdf

XT-FEMTO-SXL

XT-FEMTO-SXL

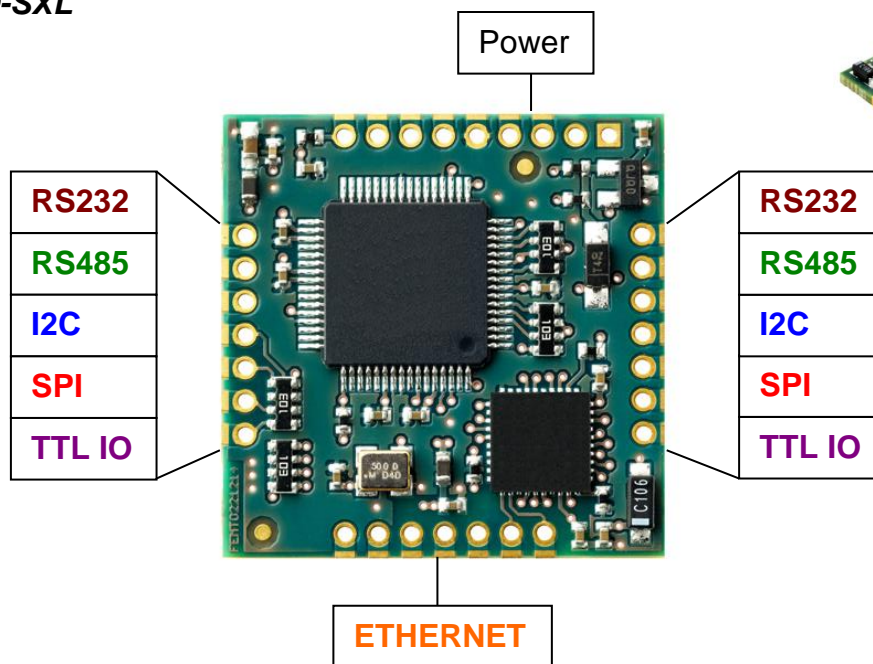

Technical description

Dimensions:	27 x 27 x 3 mm
Temperature range:	-40°C .. +85°C
Current consumption:	3.3Volt / about 170 mA
Network connections:	Ethernet 10/100Mbit (MDIX)
Network speeds:	10/100 MBit Full/Half Duplex
Network protocols:	IPv4, IPv6, TCP, TCPv6, UDP, UDPv6, FTP, TFTP ,ICMP, ICMPv6, ARP, NDP, SNMP, LPR, DHCP, DHCPv6, Netbios-NS, LLMNR, BOOTP, DNS, TELNET, HTML, DYNDNS, SMTP, POP3, SYSLOG, IEEE802.1x, ZeroConfig(AutoIP), IP-Multicast, AKM2M, SSL3.0, TLS1.0, TLS1.1, TLS1.2.
Connections:	2 x Bus TTL-Level(3.3V)
Available interfaces:	2 x RS232 , 2 x RS485 , 2 x I2C , 2 x SPI or 2 x TTL-IO
Special functions:	Modem Emulation, Connect-On-Data, Auto-Connect, Tunnel-Mode, DYNDNS-Client, FTP-Server, FTP-Client, LPR-Server, I2C – Master , SPI – Master / Slave, TTL – IO, 20KB flash drive , Flash-File-System, SD- and DF-CARD, 4bit- and SPI – DISPLAY, E-Mail – Client, TCP/UDP –Client, TCP/UDP –Server, SYSLOG-Client, M2M



Note:

This is only a short overview about the available information of the XT-FEMTO-SXL. Please find further information in the in the DesignGuide of the XT-FEMTO-SXL.

http://www.ak-nord.de/en/daten/design_guide_sxl_en.pdf

XT-NANO-SXL

XT-NANO-SXL

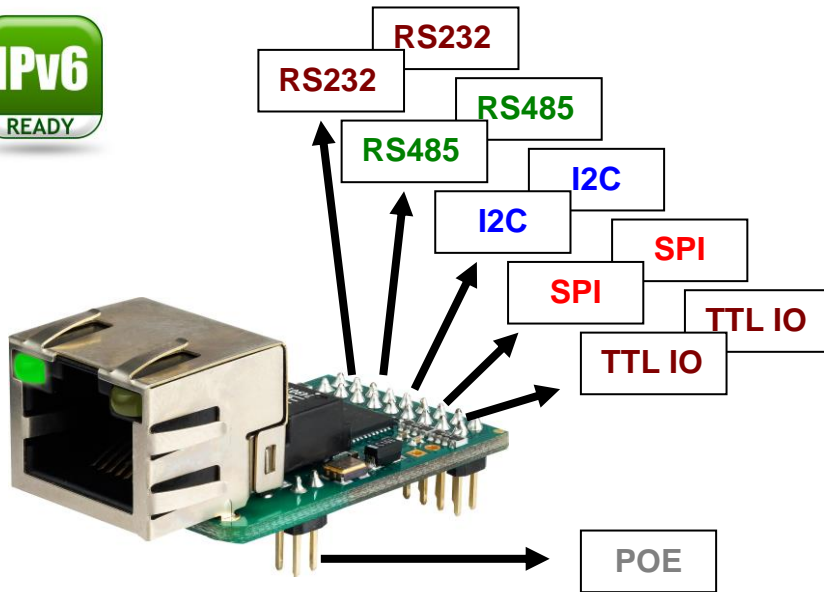

Technical description

Dimensions:	34 x 20 mm
Temperature range:	-40°C .. +85°C
Current consumption:	3.3Volt / about 170 mA
Network connections:	Ethernet 10/100Mbit (MDIX) RJ45 (PoE pins executed)
Network speeds:	10/100 MBit Full/Half Duplex
Network protocols:	IPv4, IPv6, TCP, TCPv6, UDP, UDPv6, FTP, TFTP ,ICMP, ICMPv6, ARP, NDP, SNMP, LPR, DHCP, DHCPv6, Netbios-NS, LLMNR, BOOTP, DNS, TELNET, HTML, DYNDNS, SMTP, POP3, SYSLOG, IEEE802.1x, ZeroConfig(AutoIP), IP-Multicast, AKM2M, SSL3.0, TLS1.0, TLS1.1, TLS1.2.
Connections:	2 x Bus TTL-Level(3.3V)
Available interfaces:	2 x RS232 , 2 x RS485, 2 x I2C , 2 x SPI or 2 x TTL-IO
Special functions:	Modem Emulation, Connect-On-Data, Auto-Connect, Tunnel-Mode, DYNDNS-Client, FTP-Server, FTP-Client, LPR-Server, I2C – Master , SPI – Master / Slave, TTL – IO, 20KB flash drive , Flash-File-System, SD- and DF-CARD, 4bit- and SPI – DISPLAY, E-Mail – Client, TCP/UDP –Client, TCP/UDP –Server, SYSLOG-Client



Note:

This is only a short overview about the available information of the XT-NANO-SXL. Please find further information in the in the DesignGuide of the XT-NANO-SXL.

http://www.ak-nord.de/en/daten/design_guide_sxl_en.pdf

XT-PICO-SXL

XT-PICO-SXL

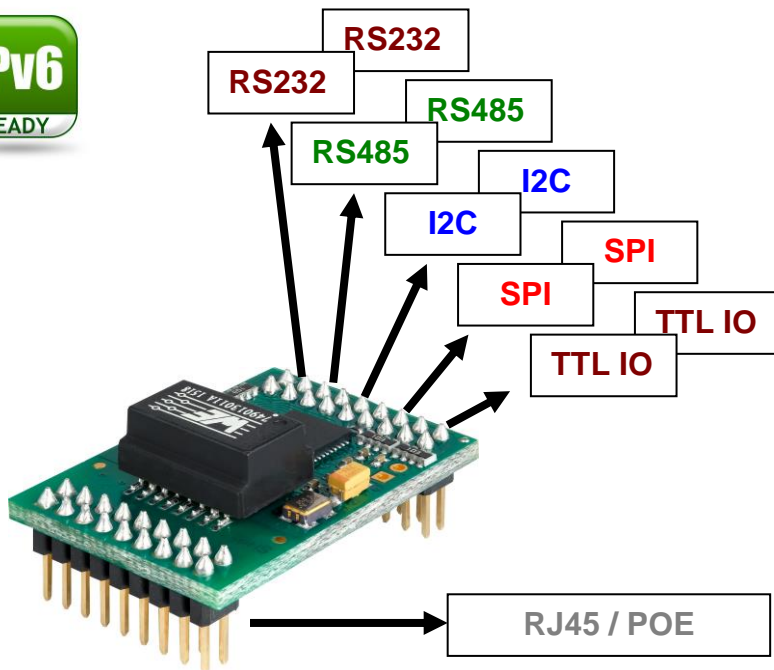

Technical description

Dimensions:	34 x 20 mm
Temperature range:	-40°C .. +85°C
Current consumption:	3.3Volt / about 170 mA
Network connections:	Ethernet 10/100Mbit (MDIX) (PoE pins executed)
Network speeds:	10/100 MBit Full/Half Duplex
Network protocols:	IPv4, IPv6, TCP, TCPv6, UDP, UDPv6, FTP, TFTP ,ICMP, ICMPv6, ARP, NDP, SNMP, LPR, DHCP, DHCPv6, Netbios-NS, LLMNR, BOOTP, DNS, TELNET, HTML, DYNDNS, SMTP, POP3, SYSLOG, IEEE802.1x, ZeroConfig(AutoIP), IP-Multicast. , AKM2M, SSL3.0, TLS1.0, TLS1.1, TLS1.2.
Connections:	2 x Bus TTL-Level(3.3V)
Available interfaces:	2 x RS232 , 2 x RS485 , 2 x I2C , 2 x SPI or 2 x TTL-IO
Special functions:	Modem Emulation, Connect-On-Data, Auto-Connect, Tunnel-Mode, DYNDNS-Client, FTP-Server, FTP-Client, LPR-Server, I2C – Master , SPI – Master / Slave, TTL – IO, 20KB flash drive , Flash-File-System, SD- and DF-CARD, 4bit- and SPI – DISPLAY, E-Mail – Client, TCP/UDP –Client, TCP/UDP –Server, SYSLOG-Client



Note:

This is only a short overview about the available information of the XT-PICO-SXL. Please find further information in the in the DesignGuide of the XT-PICO-XXL.

http://www.ak-nord.de/en/daten/design_guide_sxl_en.pdf

EVA-KIT

EVA-KIT XT-PICO-XXL



The EVA-KIT for the XT- PICO-XXL offers all functions as well as hardware options in order to completely try out the XT- PICO-XXL. Two RS232/RS485 interfaces as well as an SPI display and an SD card holder are available. Also a POE (PowerOverEthernet) module is included in the EVA-KIT. Two additional WIRE-WRAP fields of the contact spacing 2.54mm and 2mm allow using or connecting your proper hardware. Using the jumpers, it is possible to individually separate or connect each bus of the XT- PICO-XXL module. An XT- PICO-XXL and the connection plan are also included in the functional scope.

Wire-Wrap field
2,00 mm

Wire-Wrap field
2,54 mm

SD-CARD
holder

SPI
DISPLAY

RS232 /
RS485

POWER
connection

RS232 /
RS485

POE
MODUL

XT-PICO-XXL
slot

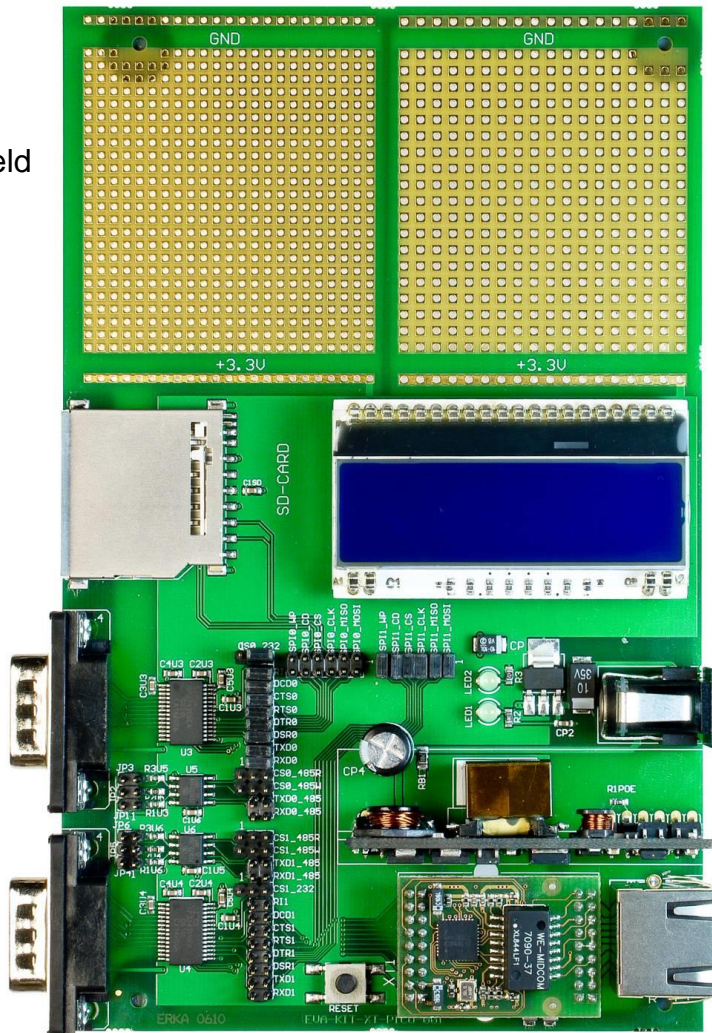

Jumper RESET
Button



Note:

This is only a short overview about the available information for the EVA-Kit. Please find further information in the brochure of the EVA-Kit and in the DesignGuide of the XT-PICO-XXL.

EVA-Kit

EVA-Kit XT-NANO-XXL



The EVA-Kit can be used to support the integration of the XT-NANO and the XT-NANO-XXL. There are 4 different connection options available. An LCD display, an SD card slot, RS232 and RS485 connections, as well as the option to make available further connections for SPI or I2C over the Wire-Wrap field which is available on the board.

Wire-Wrap field
2.00 mm

Wire-Wrap field
2,54 mm

SD-CARD
holder

SPI
DISPLAY

RS232 /
RS485

POWER
connection

RS232 /
RS485

POE
MODUL

XT-NANO-XXL
slot



Jumper RESET
Button



Note:

This is only a short overview about the available information for the EVA-Kit. Please find further information in the brochure of the EVA-Kit and in the DesignGuide of the XT-NANO respectively of the XT-NANO-XXL.

TCP/IP network

Examples of a TCP / IP network with AK-Nord products.

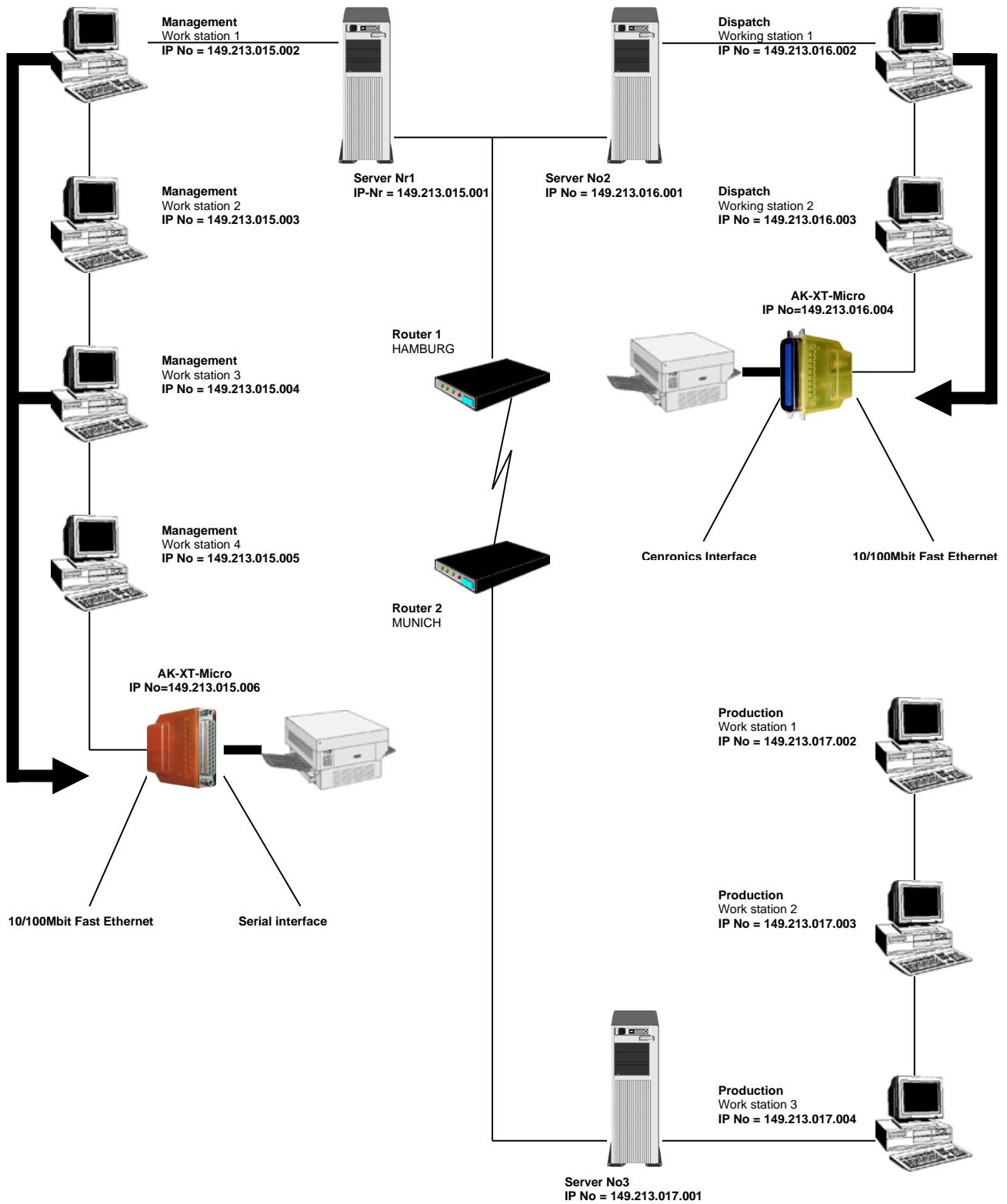

TCP/IP network

Functional principle of the AK-XXL products in the TCP/IP network

A TCP/IP network consists of one or several servers and the work stations which are connected via the network cable. Each participant in a TCP/IP network has a unique IP address and can be this way clearly identified. This IP addresses consist of 4 figures in the range from 0 to 255 (octet), separated by a dot, together:

Examples: 149.213.48.93 or 109.89.1.3 or 56.3.58.13

We distinguish 4 different classes of addresses:

1. Addresses of the class A

For the addresses of the class A, the first octet determines the network address (0 to 127) and the three other octets determine the PC address. The participant of such a network this way only have the first value in common, all other values are different (e.g. 121.213.13.22, 121.122.30.89, 121.23.111.1, etc.). This addressing type is only used in very large networks since it allows a total of 256 cubed 3 addresses.

2. Addresses of the class B

The addresses of the class B determine the network address by the first two octets and the PC names are distinguishing by the two last octets. Some IP addresses of a class B network: 139.1.0.1, 139.1.234.89, 139.1.45.9, etc. The maximum number of network participants is determined by 256 cubed 2 and the first value of the IP address is generally in the range from 128 to 191.

3. Addresses of the class C

The addresses of the class C determine the network address with the first 3 octets and the 4th octet determines the PC name. Please find following a few examples of a class C network: 101.83.12.03, 101.83.12.243, 101.83.12.120. The maximum possible number of network participants is limited to 256 and this way it is possible to address many networks with a few PCs. The common value range of the first value of the IP address ranks from 192 to 223.

4. Addresses of the class D

For addresses of the class D the four bits of highest values of the IP address = 1110 and the value range from 224 to 239 for the first value of the IP address is resulting. This addressing type is called Multicast and is used for the latest IP protocols.

AK-XXL products need to be named with a clear and correct IP address according to the above indicated classes in a TCP/IP network.

TCP/IP network

Functional principle of the AK-XXL products in the TCP/IP network

In the example on the previous page, you will learn that a network with 3 servers and three class C addresses is available. The management is working in a TCP-IP network with 4 work stations on server No 1 with the IP addresses 149.213.15.xxx, the dispatch is working with 2 work stations in a 10 MBit Ethernet network on server No 2 with the IP addresses 149.213.16.xxx and the production is working with 3 work stations on server No 3 with the IP addresses 149.213.17.xxx. The connection of the management to the dispatch is performed via a firm network wiring, the connection to the production is performed via a router with a Telekom connection. The printer of the management is connected to the Centronics interface by an AK-XXL product via the serial interface and the printer of the dispatch is connected via an XT-MICRO. Each PC of the management can generate a connection to the XT-MICRO and send print data via a spooler system, FTP or similar.

For the communication of 2 participants of the TCP/IP network across different classes it is decisive in which way the subnet mask had been defined. Each participant in the network determines with this mask which other IP participants can be reached. The target address is linked with the subnet mask by bit AND the result is compared with the target address which is extended by the subnet mask. A value of 255 in the subnet mask means that an address indication is not evaluated at this position and a value of 0 means that an evaluation is taking place.

Please find below some examples:

Own address 123.49.89.13

Subnet mask 255.255.0.0

You can reach the addresses 123.49.xxx.xxx, e.g. 123.49.200.10 or 123.49.30.3, etc.

but **not** 123.50.200.10

Own address 123.49.89.13

Subnet mask 255.255.255.0

You can reach the addresses 123.49.89.xxx, e.g. 123.49.89.10 or 123.49.89.3, etc.

but **not** 123.49.200.10

In the already described example the subnet mask of work station 3 on 255.255.0.0, as well as the network connection from the server No 1 to the server No 2 need to be set to 255.255.0.0 in order to create a connection from work station 3 of the management to the AK-XXL products.

For network connections via the router also a connection via the subnet mask needs to be released and the routing needs to be configured with a Default- gateway entry via the corresponding router.

TCP/IP Netzwerk

Port description

TCP Ports					
Local Port	Remote Port	Protocol	Type	Application	Switchable
20		FTP	Server	FTP-Server	Y
21		FTP	Server	FTP-Server	Y
23		Telnet	Server	Console, Config	Y
	25	SMTP	Client	E-Mail	Y
80		HTTP	Server	Webserver, Config	Y
	80	HTTP	Client	DynDns	Y
	110	POP3	Client	E-Mail	Y
443		HTTPS	Server	Webserver, Config	Y
515		LPR	Server	Printserver	N
990		FTPs	Server	FTP-Server	Y
1002		TCP	Server	Interface1	N/Y
1003		TCP	Server	Interface2	N/Y
3000		TCP	Server	Interface1	N
3001		TCP	Server	Interface2	N
6500		TCP	Server	Interface1	N
6501		TCP	Server	Interface2	N
9100		TCP	Server	Interface1	N
9101		TCP	Server	Interface2	N
10001		TCP	Server	Interface1	N
10002		TCP	Server	Interface2	N
11011		TCP	Server	Interface1 (Serial)	N
22022		TCP	Server	Interface2 (Serial)	N
1500 - 1600				Used source ports	

UDP Ports					
Local Port	Remote Port	Protocol	Type	Application	Switchable
	53	DNS	Client	Domain Name System	N
68	67	DHCP	Client	IPv4	Y
69		TFTP	Server	AK-NORD Update	Y
	123	NTP	Client	Network Time Protocol	Y
137		NB-NS	Server	NetBIOS Name Service	N
161		SNMP	Server	SNMP Status	N
	162	SNMP	Client	SNMP TRAP	Y
	514	SYSLOG	Client	Console	Y
546	547	DHCP IPv6	Client	DHCP IPv6	Y
5355		LMNR	Server	Name resolution	Y
54321		UDP	Server	AK-Nord Config	Y
	55555	UDP	Client	AK-Nord M2M	Y
1002		UDP	Server	Interface1	N/Y
1003		UDP	Server	Interface2	N/Y
3000		UDP	Server	Interface1	N
3001		UDP	Server	Interface2	N
6500		UDP	Server	Interface1	N
6501		UDP	Server	Interface2	N
9100		UDP	Server	Interface1	N
9101		UDP	Server	Interface2	N
10001		UDP	Server	Interface1	N
10002		UDP	Server	Interface2	N
1500 - 1600				Used source ports	

TCP/IP Netzwerk

Description of the special ports:

- 11011:** Via this port it is possible to control all signals, baud rates, data bits and the flow control of the COM1. There is an additional detailed description for this port. You can use this port in the program “**VirtualCom**“. All properties will then be transmitted to the interface.
- 22022:** Via this port it is possible to control all signals, baud rates, data bits and the flow control of the COM2. There is an additional detailed description for this port. You can use this port in the program “**VirtualCom**“. All properties will then be transmitted to the interface.



Note:

The exact description as well as the programming instruction can be requested from AK-NORD.

Emulations (operating modes)

Overview of the emulations (operating modes)

TCPSEVER emulation This is the standard emulation. For this operating mode incoming TCP/IP network connections are received on the TCP port 1002 and the data are output on the interface. The different connections of the Device server are addressed via different ports. The first connection is done via 1002 and the second via 1003 and so on. Such ports can be individually configured in the interface menu with the option "Local Port".

UDPSERVER emulation The TCPSEVER description also applies for the UDPSERVER emulation. The only difference is that the connection is created via the UDP network protocol and not via the TCP protocol.

TCPCLIENT emulation The emulation TCP -CLIENT is used if the device server shall automatically connect to a target in the network. The connection can be created in 3 different modes. All three modes can be used with the operating modes **SINGLE** and **MULTI**. **SINGLE** means that the data are transferred to the first target which is entered in the list if this target is available. If the first target is not available it is being tried to reach the second and then the third target, etc.. The Setup Timeout displays how long it is being tried to connect to the corresponding target, In the operating mode **MULTI** the data are transferred to all targets at the same time. The connection is bidirectional and transparent. As long as a connection is established, data can be sent from the interface to the PC as well as from the PC to the interface.

To do so, there are three options available:

<i>AutoConnect</i>	<i>ConnectOnData</i>	<i>Tunnel</i>
Here the connection is created immediately after the booting of the device server and it is not disconnected.	in this mode the connection is only created if necessary, i.e. if data are received on the serial interface of the device server. If no more data are transferred, the connection is disconnected automatically upon expiry of the Port Timeout. You can influence in the TCP menu which submenu is a network menu.	This special mode behaves in the same way as the AutoConnect mode from the moment on when the connection is created. The difference is that control characters are transmitted in addition to the net data. With such control characters the signal lines of the serial interface are transferred bidirectionally. This can be used as transparent almost complete cable elongations via the network. The disadvantage of this emulation is the reduced throughput of net data due to the control characters.

UDPCLIENT emulation The TCPCLIENT description also applies for the UDPCLIENT emulation. The difference is that the connection is created via the UDP network protocol and not via the TCP protocol.

Emulations (operating modes)

EMAIL emulation

Using the EMAIL emulation it is possible to send data or texts by e-mail to the device server via the corresponding serial interfaces. It is possible to send the recipient in the data flow or firmly preset it via the device server configuration. The data can be sent as TEXT, in a HTML message or as ATTACHEMENT.

MODEM emulation

The Modem emulation offers the option to completely control the connected terminal of the AK-NORD interfaces. It is possible to assign an IP address, gateway, a subnet mask, port, etc. to the AK-Nord interface and to transfer a connection request. The terminal can create a connection to different targets in the network and terminate such connections.

POP3 function

POP3 is not directly being regarded as emulation for our device server. POP3 is active as soon as the function is activated in the network menu and will not be set as emulation in the interface. Using the POP3 function, it is possible to receive e-mails (or to pick them up from the POP3). The contents will then be output to one of the serial connections. This can be controlled, e.g. via the object line



Examples of applications

Please find examples for applications of the different emulations or operating modes at the end of this document.

Menu structure

Please find the internal menu structure of the AK-XXL products on the following pages.

Legend:

The different menu items are color-coded as follows.

Menu on the first level

Menu on the second level

Configuration options

Display for status information

Menu structure

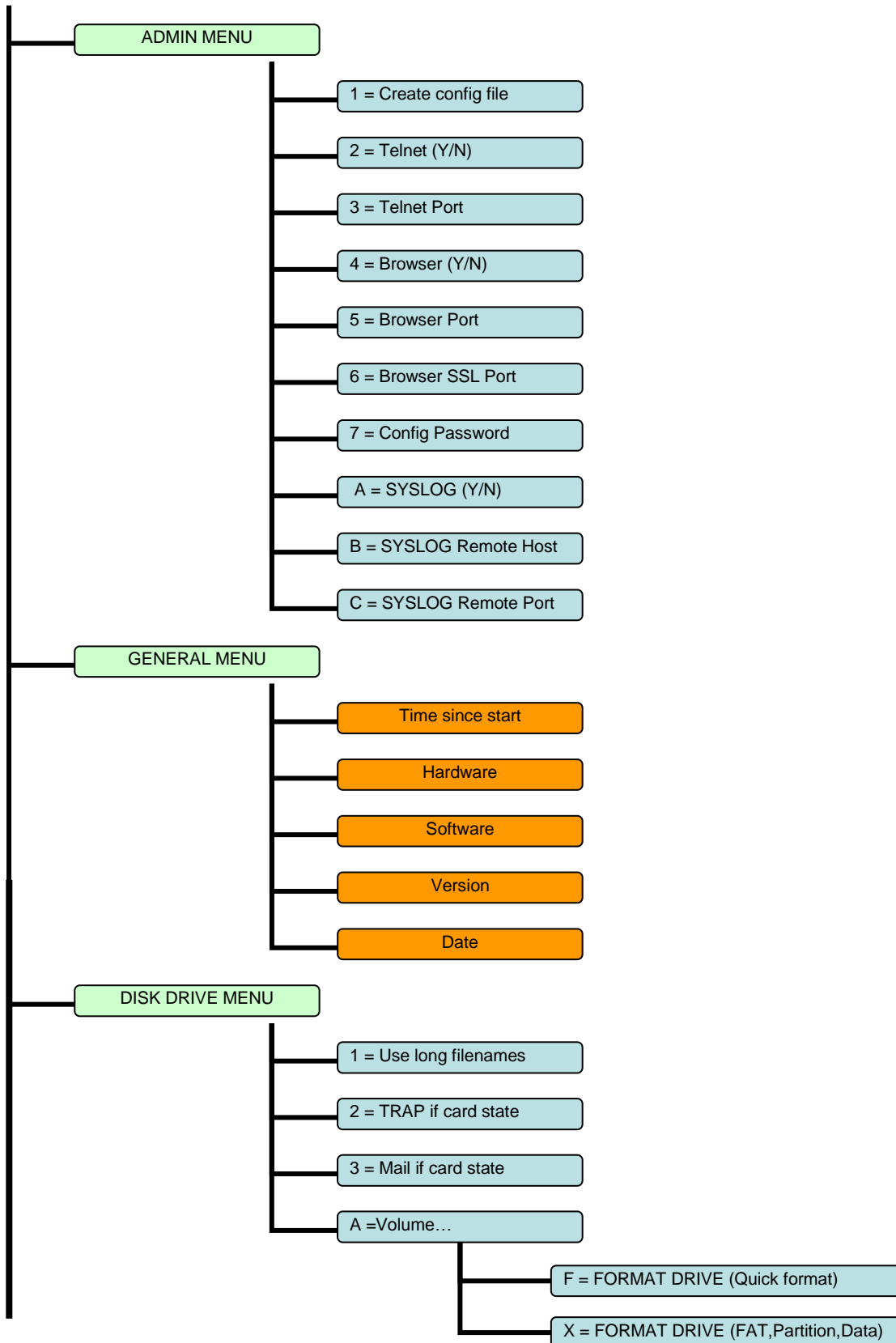

Menu structure

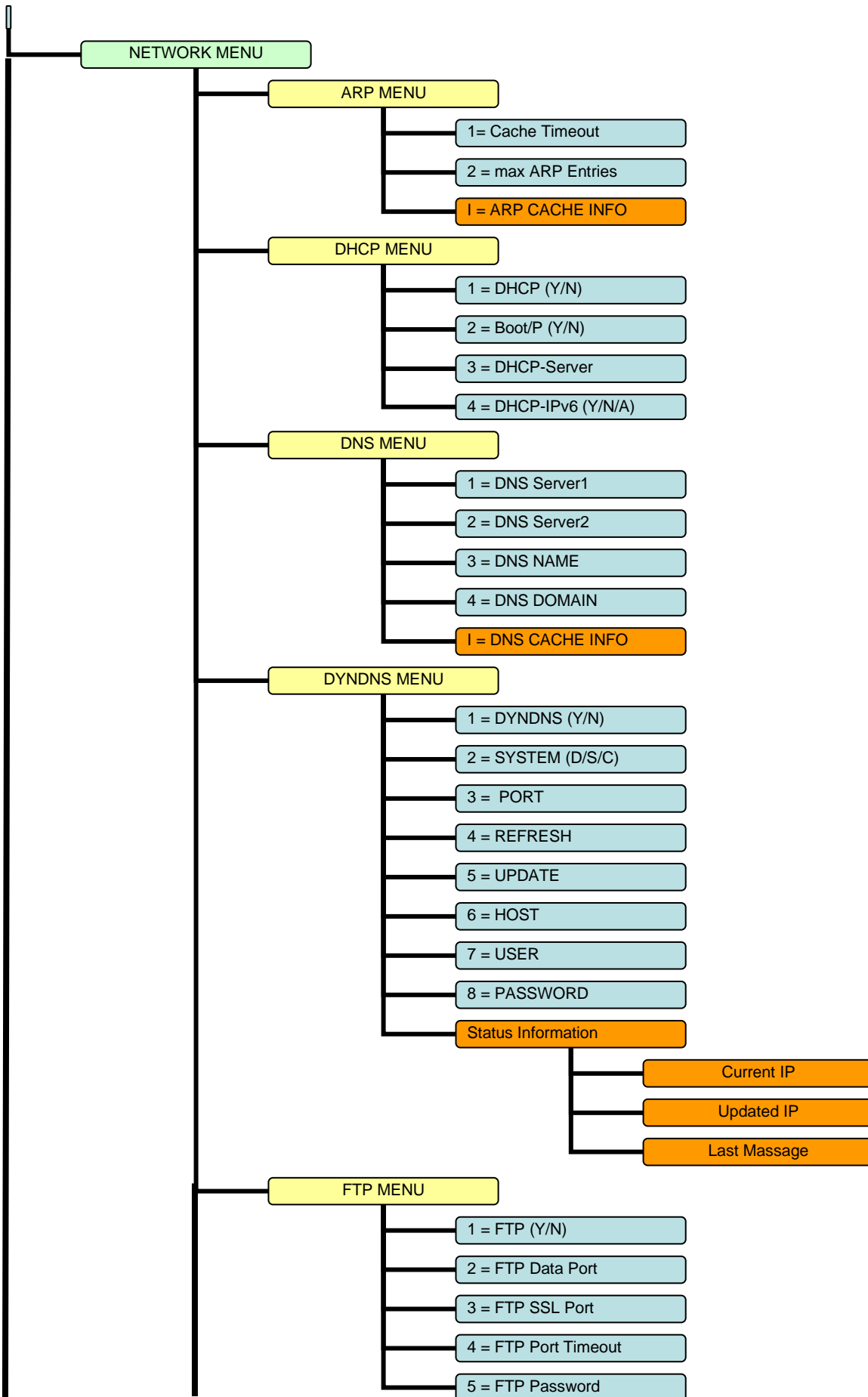

Menu structure

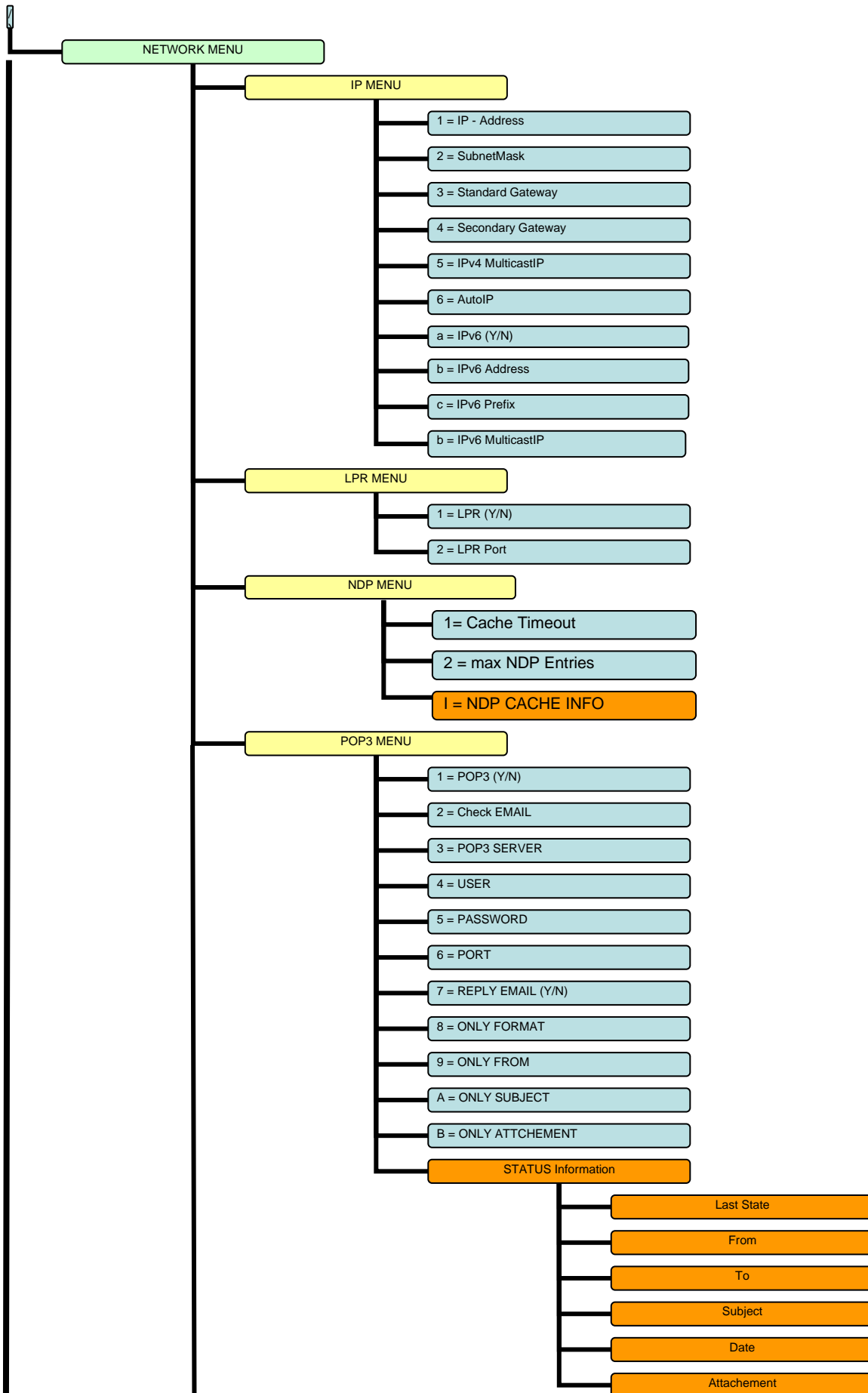

Menu structure

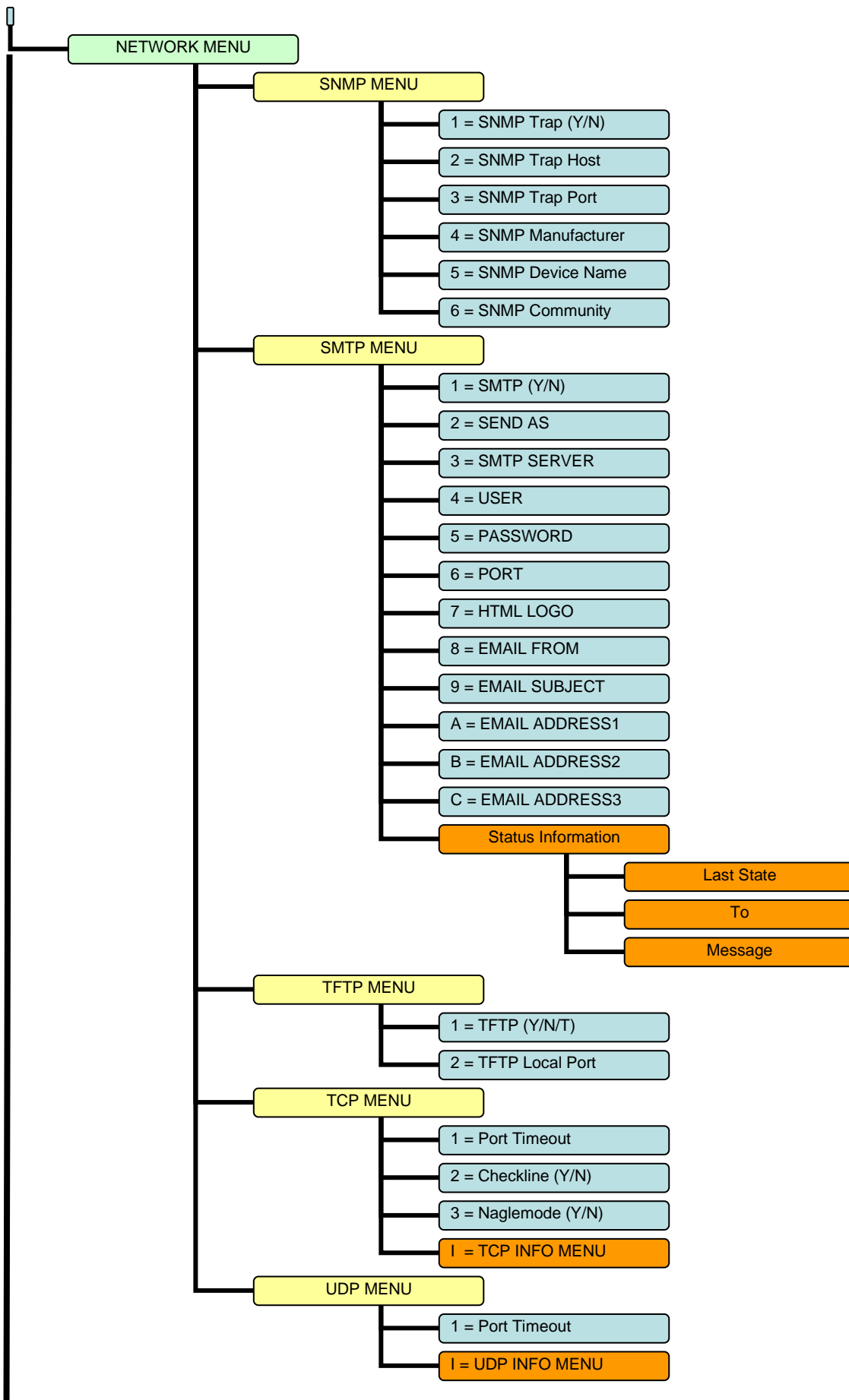

Menu structure

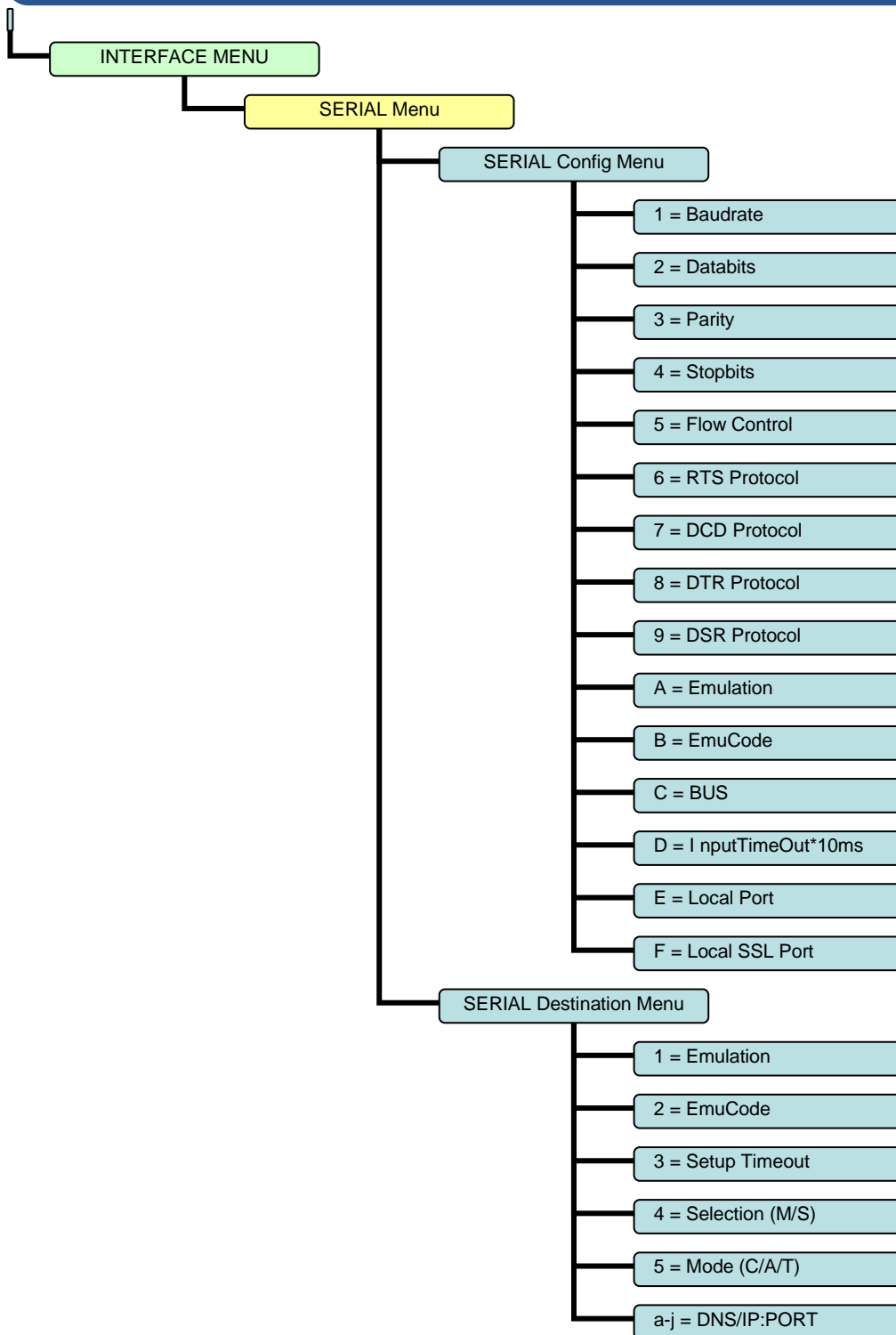

Menu structure

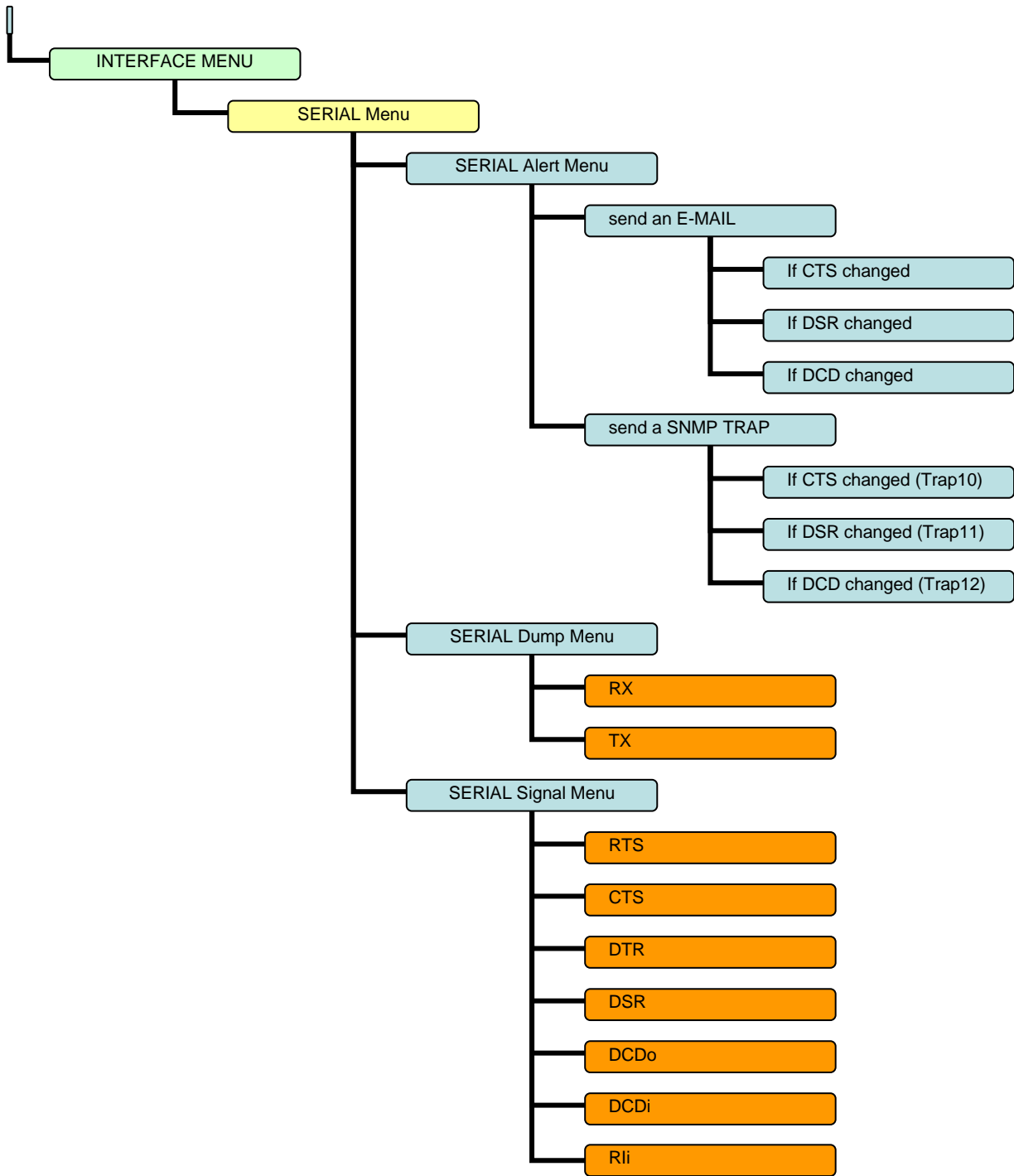

Configuration with TELNET

Configuring AK-XXL products



- 1.) The AK-XXL product is switched on.
- 2.) The IP Adresse is set (and/or unknown). Refer to "Setting the IP address"
- 3.) The AK-XXL product is not occupied
- 4.) The program "TELNET" is available.

Example:

The settings for AK-XXL products shall be checked.

Start the program Telnet. You will find it either on the PC in the directory "WINDOWS" or it is available on a system (OS/2 , Linux) by entering "TELNET" + < ENTER>. Then it is possible to connect to the AK-XXL products by entering the IP address.

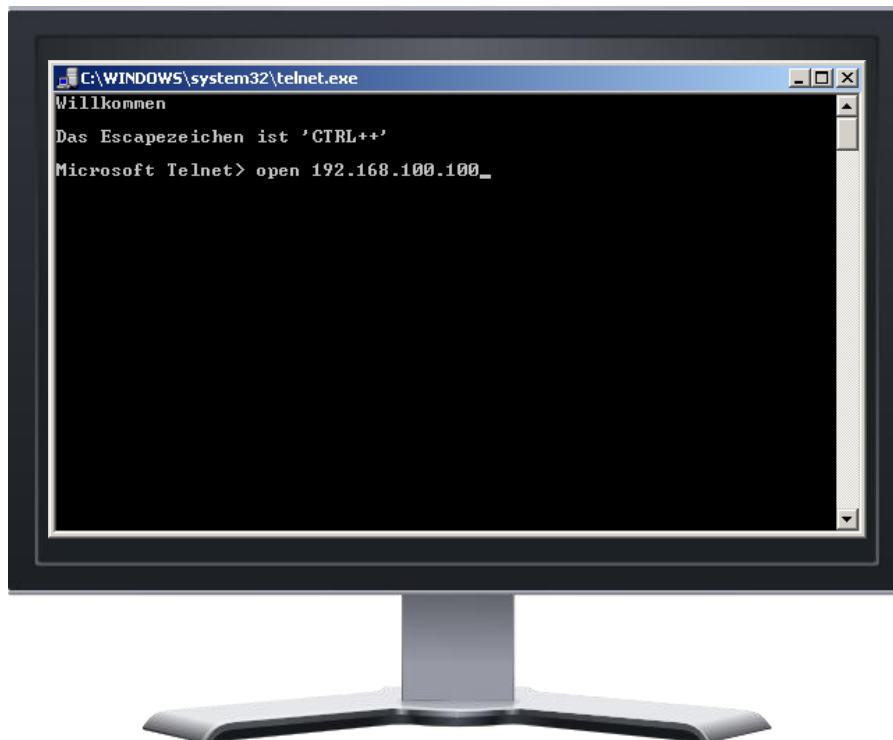

Configuration with TELNET

Configuring AK-XXL products

If you have entered the correct IP address of AK-XXL products, the message "Password Menu" is displayed on the screen. Enter "XT" for the password request.

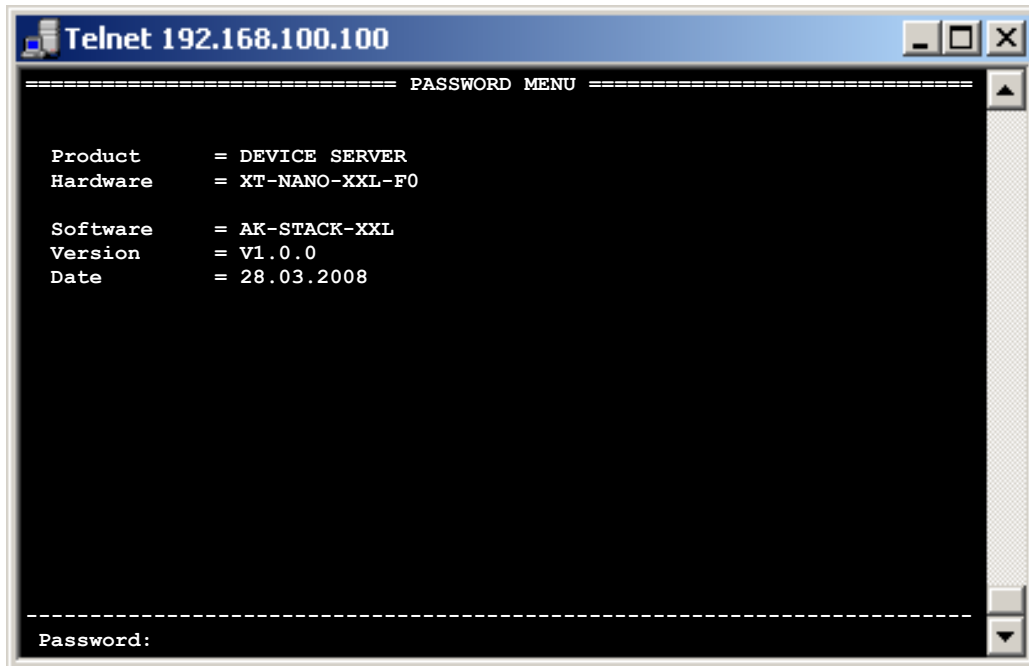

```
Telnet 192.168.100.100
=====
===== PASSWORD MENU =====

Product = DEVICE SERVER
Hardware = XT-NANO-XXL-F0

Software = AK-STACK-XXL
Version = V1.0.0
Date = 28.03.2008

-----
Password:
```

Then press the RETURN key, a short overview of the options for the configuration is displayed.

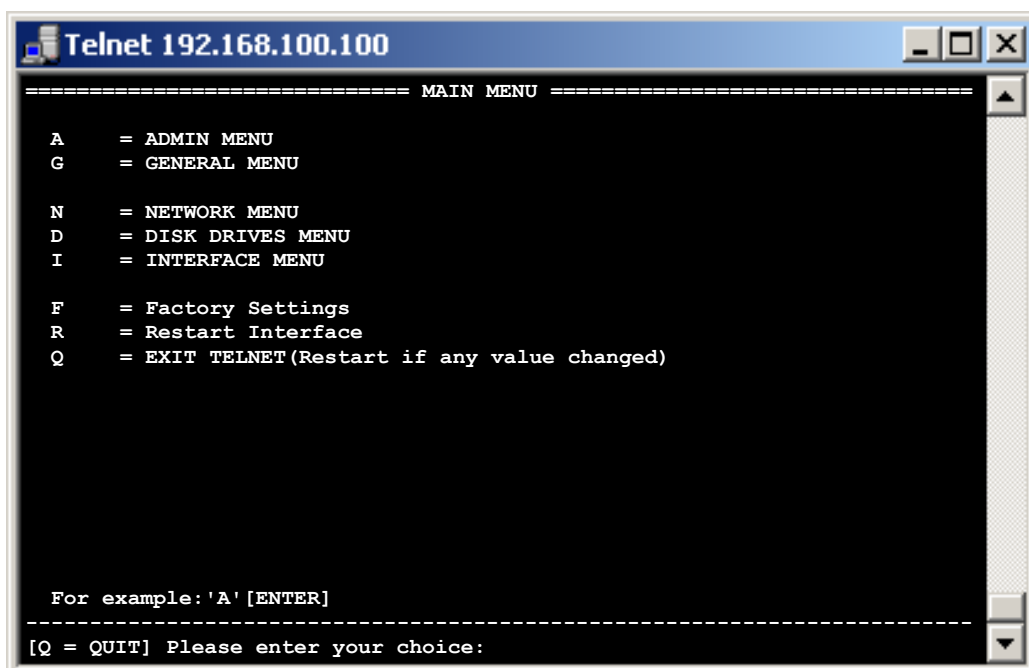

```
Telnet 192.168.100.100
=====
===== MAIN MENU =====

A = ADMIN MENU
G = GENERAL MENU

N = NETWORK MENU
D = DISK DRIVES MENU
I = INTERFACE MENU

F = Factory Settings
R = Restart Interface
Q = EXIT TELNET(Restart if any value changed)

For example: 'A' [ENTER]
-----
[Q = QUIT] Please enter your choice:
```

Configuration with TELNET

ADMIN MENU

Item A, the “ADMIN MENU“

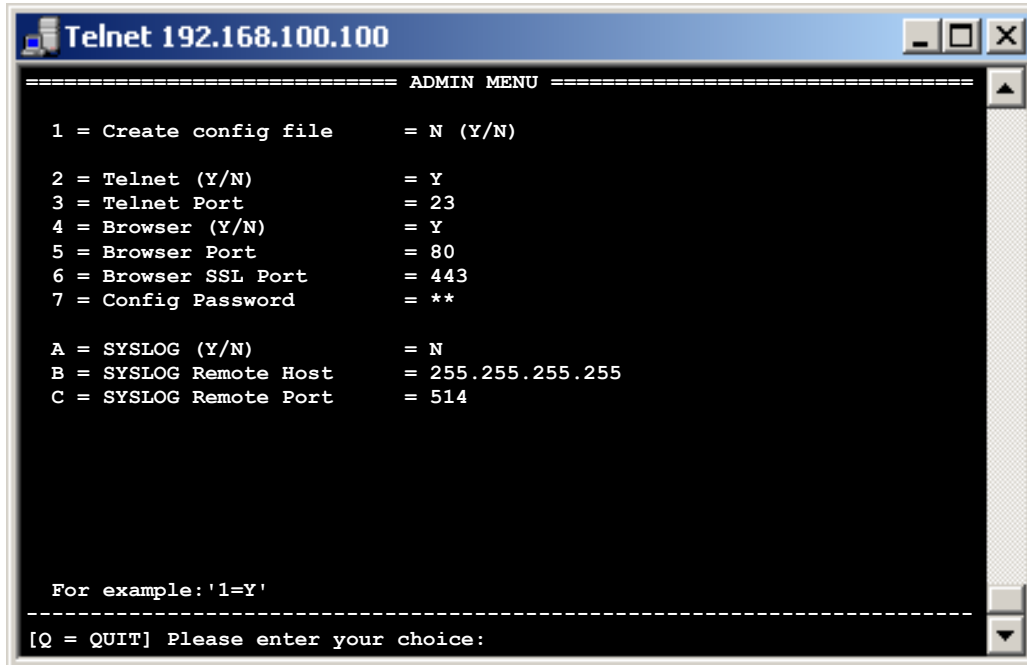

```
Telnet 192.168.100.100
===== ADMIN MENU =====
 1 = Create config file      = N (Y/N)
 2 = Telnet (Y/N)           = Y
 3 = Telnet Port             = 23
 4 = Browser (Y/N)          = Y
 5 = Browser Port           = 80
 6 = Browser SSL Port       = 443
 7 = Config Password        = **

 A = SYSLOG (Y/N)           = N
 B = SYSLOG Remote Host     = 255.255.255.255
 C = SYSLOG Remote Port     = 514

For example: '1=Y'
-----
[Q = QUIT] Please enter your choice:
```

- | | |
|--------------------------------------|---|
| 1 = Create config file (Y/N): | Using this function an EEPROM file can be set with the current settings. It is possible to download this file by FTP from the AK-XXL product. |
| 2 = Telnet (Y/N): | Using this item, it is possible to deactivate the TELNET function of the device. |
| 3 = Telnet Port: | Here you change the port for the TELNET access. |
| 4 = Browser (Y/N): | Here it is possible to deactivate the browser function.
<i>Note: In order to be able to configure the device via the network, it is necessary that either the TELNET or the BROWSER function is activated.</i> |
| 5 = Browser Port: | With this function you can change the access port for the browser configuration. |
| 6 = Browser SSL Port: | Change the SSL access port for the browser configuration. |
| 7 = Config Password: | Using this function you can change the password for the configuration access |
| A = SYSLOG (Y/N): | Using this menu item it is possible to activate and deactivate the SYSLOG function. |
| B = SYSLOG Remote Host: | By default the SYSLOG messages are sent as broadcast, however it is possible to enter a direct target. <i>Example: B=192.168.0.26</i> |
| C = SYSLOG Remote Port: | Using this function it is possible to change the target port for SYSLOG. |

Configuration with TELNET

GENERAL MENU

Item G, the “GENERAL MENU“

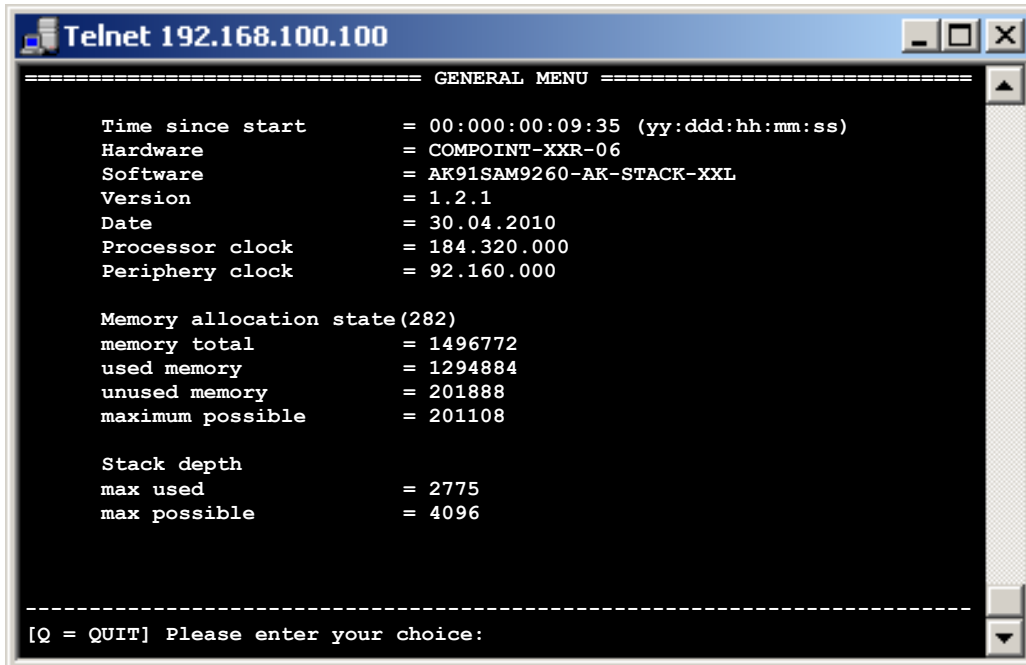

```
Telnet 192.168.100.100
===== GENERAL MENU =====
Time since start      = 00:000:00:09:35 (yy:ddd:hh:mm:ss)
Hardware              = COMPOINT-XXR-06
Software              = AK91SAM9260-AK-STACK-XXL
Version               = 1.2.1
Date                  = 30.04.2010
Processor clock       = 184.320.000
Periphery clock       = 92.160.000

Memory allocation state (282)
memory total          = 1496772
used memory           = 1294884
unused memory         = 201888
maximum possible      = 201108

Stack depth
max used              = 2775
max possible          = 4096

-----
[Q = QUIT] Please enter your choice:
```

The information regarding the interface are displayed under the menu item “GENERAL Menu“. In this menu you can read the current firmware version.

Configuration with TELNET

Configuring AK-XXL products

NETWORK MENU

Configuration with TELNET

NETWORK-MENU

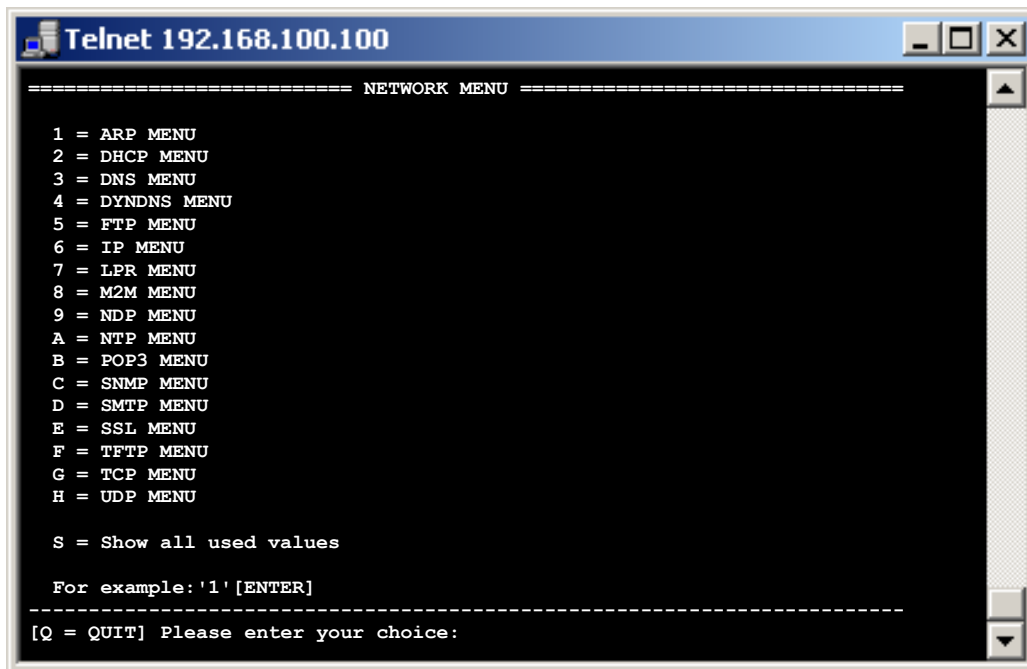

```
Telnet 192.168.100.100
===== NETWORK MENU =====

1 = ARP MENU
2 = DHCP MENU
3 = DNS MENU
4 = DYNDNS MENU
5 = FTP MENU
6 = IP MENU
7 = LPR MENU
8 = M2M MENU
9 = NDP MENU
A = NTP MENU
B = POP3 MENU
C = SNMP MENU
D = SMTP MENU
E = SSL MENU
F = TFTP MENU
G = TCP MENU
H = UDP MENU

S = Show all used values

For example: '1' [ENTER]
-----
[Q = QUIT] Please enter your choice:
```

- | | |
|-------------------------|---|
| 1 = ARP MENU: | In the ARP menu it is possible to set the Timeout for ARP entries. Additionally it is possible to view the ARP-Cache |
| 2 = DHCP MENU: | Under the DHCP menu it is possible to switch the DHCP and BOOTP function and also directly enter a DHCP server |
| 3 = DNS MENU: | By means of this menu it is possible to set the DNS name and the domain of the device as well as two DNS servers. Additionally it is possible to view the DNS-Cache. |
| 4 = DYNDNS MENU: | Using this function it is possible to set the DYNDNS function by entering the user name, password and the DYNDNS name. To do so, a user account at http://www.dyndns.com/ is required. |
| 5 = FTP MENU: | Using this menu it is possible to influence the FTP function by changing the access port or the password. |
| 6 = IP MENU | In the IP menu it is possible to set the IP address and the subnet mask. |
| 7 = LPR MENU | Using this menu item it is possible to deactivate the LPR function or to change the port. |
| 8 = M2M MENU | Using this menu item it is possible to reach this interface via the internet. |
| 9 = NDP MENU | In the NDP menu it is possible to set the Timeout for NDP entries. Additionally it is possible to view the NDP-Cache |
| A = NTP MENU | Network time protocol settings |
| B = POP3 MENU | With the help of this menu you can set a POP3 account. Using this account you can then receive e-mails and send data via an attachment or via the message contents at the interface of a AK-XXL product. |
| C = SNMP MENU | The SNMP menu is used to enter an SNMP-Trap-Host or to set the SNMP-Community. |
| D = SMTP MENU | Using this option it is possible to set an account for outgoing e-mails. It is possible to send it in the HTML, ATTACHEMENT or in the TEXT format. It is also possible to send with SMTP-AUTH. |
| E = SSL MENU | TLS/SSL settings |
| F = TFTP-MENU | Using this function it is possible to activate the update function via TFTP and to set the port of the TFTP server. |
| G = TCP-MENU | Using this menu item it is possible to adapt the TCP-Port Timeout and switch the functions CheckLine and Naglemode. Additionally it is possible to check the open TCP connections. |
| H = UDP-MENU | Using the UDP menu it is possible to set the UDP-Timeout and view the used connections. |



Note:

Enter "q" for quit in order to quit the menu. All modified values will be automatically saved.
"S" will show you the currently used values.

Configuration with TELNET

ARP Menu

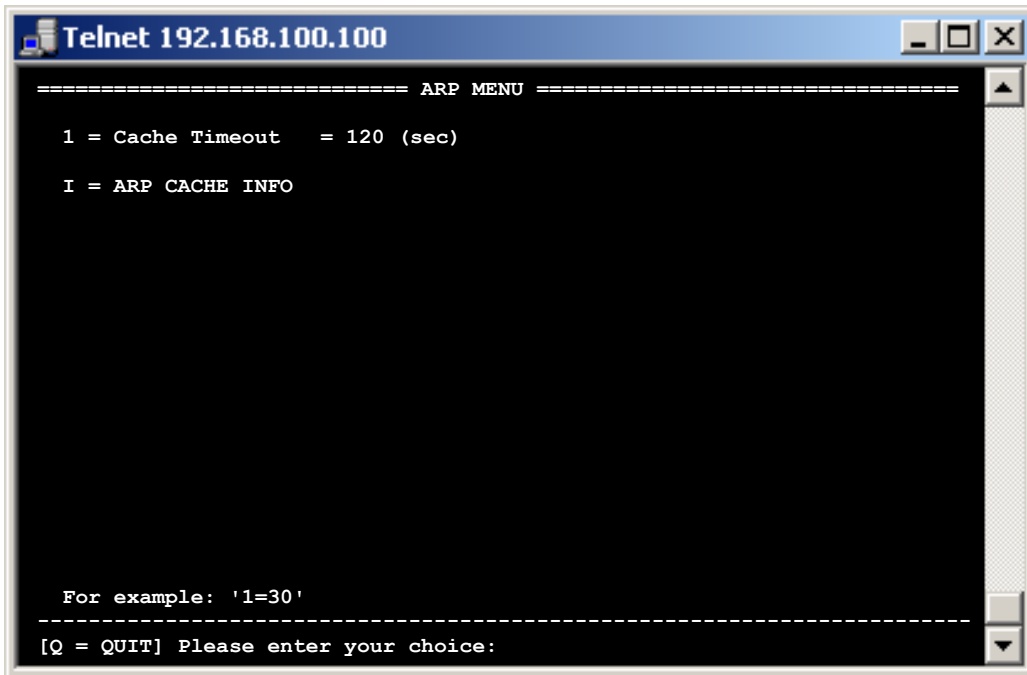

```
Telnet 192.168.100.100
===== ARP MENU =====
1 = Cache Timeout = 120 (sec)
I = ARP CACHE INFO

For example: '1=30'
-----
[Q = QUIT] Please enter your choice:
```

- 1=Cache Timeout :** The Cache Timeout designates the period until an inactive ARP entry is being deleted.
Example: 1=60
- I= ARP CACHE INFO :** Using this function it is possible to view the existing ARP entries.

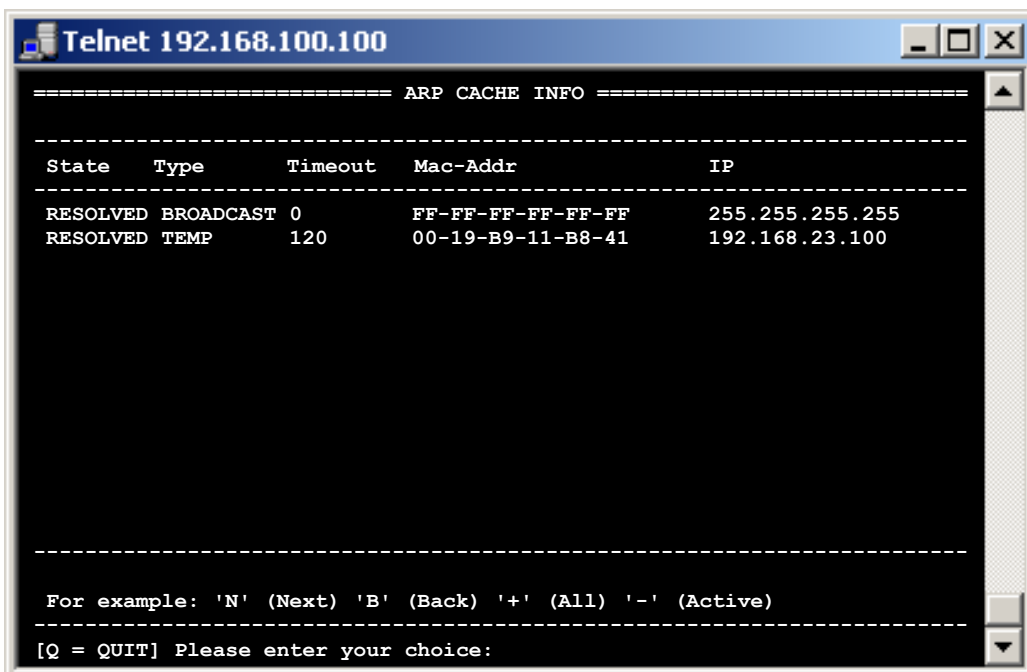

```
Telnet 192.168.100.100
===== ARP CACHE INFO =====
-----
State   Type      Timeout  Mac-Addr      IP
-----
RESOLVED BROADCAST 0        FF-FF-FF-FF-FF-FF 255.255.255.255
RESOLVED TEMP      120     00-19-B9-11-B8-41 192.168.23.100
-----

For example: 'N' (Next) 'B' (Back) '+' (All) '-' (Active)
-----
[Q = QUIT] Please enter your choice:
```

State	Explanation
Resolved	Resolved means that an ARP request has taken place and a MAC address had been reported back to the IP 192.168.23.100 from a terminal.
Pending (still needs to be done)	Such entries had been requested in the network but not yet responded by a terminal.
FREE	A free space for a possible additional ARP entry (will only be listed to activate the <ALL> display. In order to activate the <ALL> enter a "+")

Configuration with TELNET

DHCP Menu

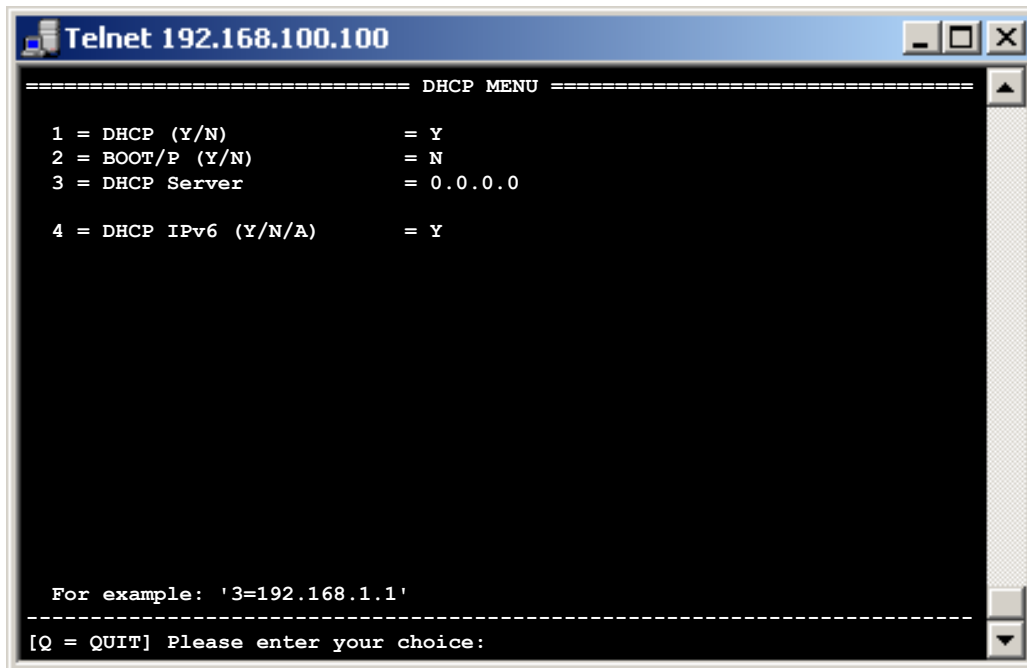

```
Telnet 192.168.100.100
===== DHCP MENU =====
1 = DHCP (Y/N)           = Y
2 = BOOT/P (Y/N)        = N
3 = DHCP Server          = 0.0.0.0
4 = DHCP IPv6 (Y/N/A)    = Y

For example: '3=192.168.1.1'
-----
[Q = QUIT] Please enter your choice:
```

- 1 = DHCP (Y/N) :** Using this functions it is possible to activate or deactivate the DHCP function for IPv4.
- 2 = BOOT/P (Y/N) :** Using this configuration item it is possible to activate or deactivate the BOOT/P
- 3 = DHCP Server :** If the IP address of the DHCP server is known or if you want to select a certain DHCP server it is possible to enter it here.
Example: a=192.168.0.35
- 4 = DHCP IPv6 (Y/N/A):** Here it is possible to activate resp. deactivate the DHCP function for IPv6.
Y = always ON
N = always OFF
A = automatic. If an IPv6 address is assigned by the router the DHCPv6 is not activated.

Configuration with TELNET

DNS Menu

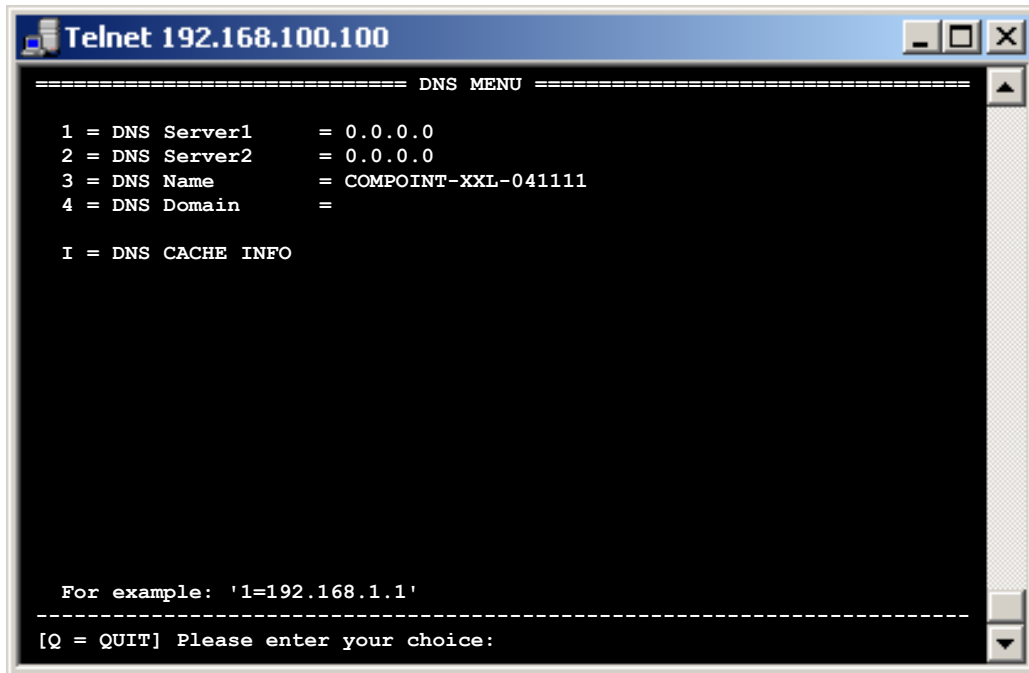

```
Telnet 192.168.100.100
===== DNS MENU =====
1 = DNS Server1      = 0.0.0.0
2 = DNS Server2      = 0.0.0.0
3 = DNS Name         = COMPOINT-XXL-041111
4 = DNS Domain       =
I = DNS CACHE INFO

For example: '1=192.168.1.1'
-----
[Q = QUIT] Please enter your choice:
```

- 1 = DNS Server1** : If an DNS server is available or if you want to select a certain DNS server it is possible to enter it here.
Example: b=192.168.0.66
- 2 = DNS Server2** : If a 2nd DNS server is available, enter it here.
Example: c=192.168.0.67
- 3 = DNS Name** : If you use DNS, it is possible to enter the DNS name here.
Example: 4=Compoint-XXL
- 4 = DNS Domain** : If a domain is available, you can enter it here.
Example: d=musterdomain.de
- I = DNS CACHE INFO** : Usig this function it is possible to view the performed DNS requests and their results

Configuration with TELNET

Configuring AK-XXL products

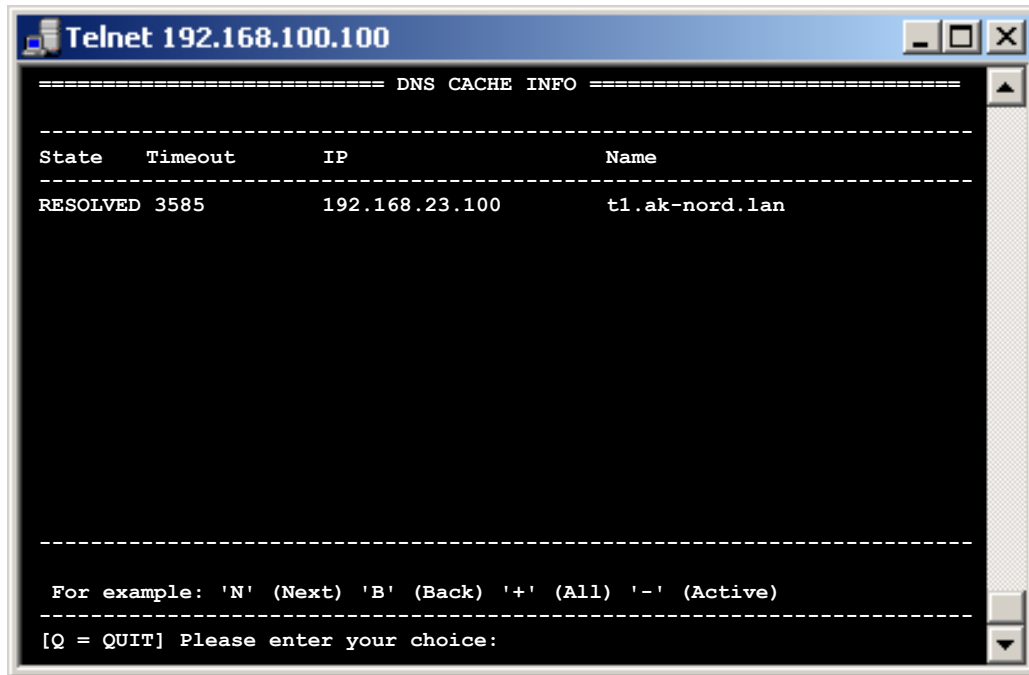

The screenshot shows a Telnet window titled "Telnet 192.168.100.100". The main content is a table of DNS cache information. The table has four columns: State, Timeout, IP, and Name. A single row is visible with the following values: RESOLVED, 3585, 192.168.23.100, and t1.ak-nord.lan. Below the table, there is a prompt: "For example: 'N' (Next) 'B' (Back) '+' (All) '-' (Active) [Q = QUIT] Please enter your choice:".

```
Telnet 192.168.100.100
===== DNS CACHE INFO =====
-----
State   Timeout   IP           Name
-----
RESOLVED 3585      192.168.23.100  t1.ak-nord.lan
-----

For example: 'N' (Next) 'B' (Back) '+' (All) '-' (Active)
[Q = QUIT] Please enter your choice:
```

State
Resolved

Explanation

Resolved means that a DNS request has taken place and that an IP address for the DNS name t1.ak-nord.lan had been responded by an DNS server.

Pending
(still needs to be done)

Such entries had been requested via the DNS server but had not yet been responded by it

FREE

A free space for a possible additional ARP entry (will only be listed to activate the <ALL> display. In order to activate the <ALL> display enter a "+")

Configuration with TELNET

DYNDNS Menu

```
Telnet 192.168.100.100
===== DYNDNS MENU =====
1 = DYNDNS (Y/N)      = Y
2 = SYSTEM (D/S/C)   = D
3 = PORT              = 80
4 = REFRESH          = 10 (min)
5 = UPDATE           = 20 (days)

6 = HOST              = ak-handbuch-test.dyndns.org
7 = USER             = ak-nord
8 = PASSWORD         = *****

Last Message        = GOOD
Current IP          = 84.141.36.211
Updated IP         = 84.141.36.211

For example: '2=D'
-----
[Q = QUIT] Please enter your choice:
```

- | | |
|--------------------------|--|
| 1 = DYNDNS Y/N | Here you can determine via “Y” = Yes or “N” = No, if this function is active. |
| 2 = SYSTEM D/S/C | Here you select the type of the process.
D = Dynamic / S = Static / C = Custom |
| 3 = PORT | Here you can determine the target port of the requests or of the registration. Either port 80 = web server or 8245 to bypass the proxy server. |
| 4 = REFRESH * min | Here you determine in which intervals the checking of the IP address is taking place. |
| 5 = UPDATE * days | Here you determine when the new registration of the IP address will take place at the latest on the DYNDNS server. This entry only applies if your IP address does not change within the determined period of time. DYNDNS prescribes the registration after 27 days at the latest. Otherwise the name resolution e.g. mydev.dyndns.org will no longer be responded. |
| 6 = HOST | Includes your account data by which you have registered at DYNDNS. |
| 7 = USER | |
| 8 = PASSWORD | |
| Last Message | current status |
| Current IP | current IP address of router1 |
| Updated IP | saved IP address |



NOTE:

If several AK-Nord interfaces should be available, please only activate one for the DYNDNS procedure. The availability of the different interfaces can be accessed via the PORT – FORWARDING within your router /firewall system

Configuration with TELNET

FTP Menu

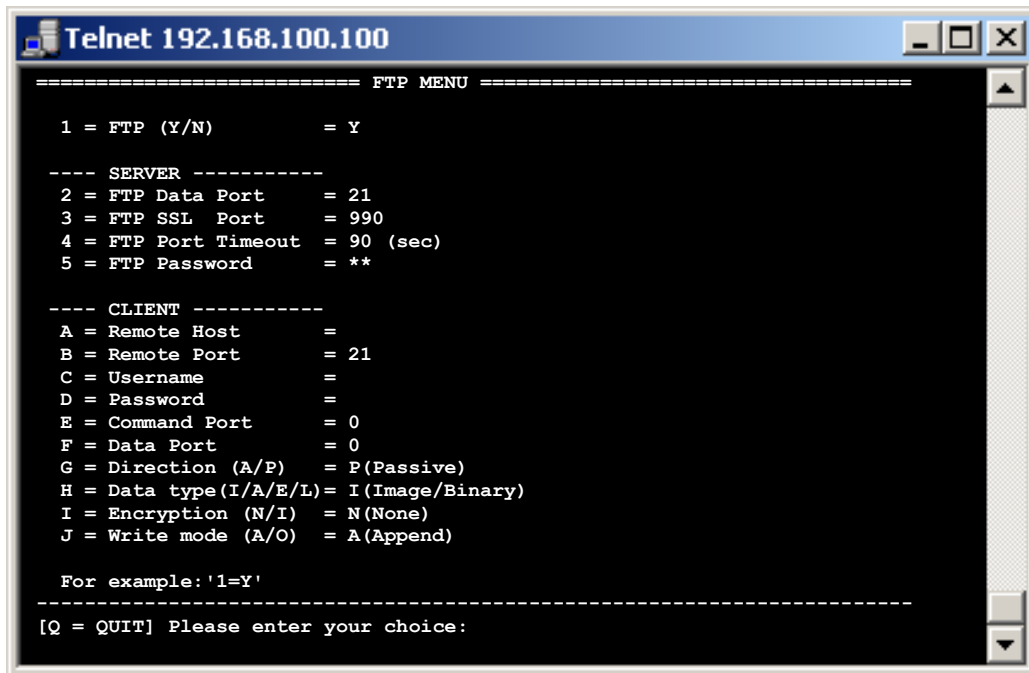

```
Telnet 192.168.100.100
===== FTP MENU =====
1 = FTP (Y/N)           = Y
---- SERVER ----
2 = FTP Data Port      = 21
3 = FTP SSL Port       = 990
4 = FTP Port Timeout   = 90 (sec)
5 = FTP Password       = **
---- CLIENT ----
A = Remote Host        =
B = Remote Port        = 21
C = Username           =
D = Password           =
E = Command Port       = 0
F = Data Port          = 0
G = Direction (A/P)    = P(Passive)
H = Data type(I/A/E/L) = I(Image/Binary)
I = Encryption (N/I)   = N(None)
J = Write mode (A/O)   = A(Append)

For example: '1=Y'
-----
[Q = QUIT] Please enter your choice:
```

1 = FTP (Y/N) Using this option you can activate or deactivate the function FTP server/client

Server:

2 = FTP Data Port With the help of this item it is possible to change the access port for the internal FTP server.

3 = FTP SSL Port Same as “FTP Data Port”. But this applies for the SSL access

4 = FTP Port Timeout This configuration item represents the term of the possible idle time of a TCP/IP network connection to the FTP server

5 = FTP Password Using this option it is possible to create the password for the FTP access. “xt” is entered as standard

Client:

See Modem-Emulation and manual „manual_at_commands“.



NOTE:

When accessing the FTP server the user name is of no importance, only the password which is set in this menu will be checked by the interface. “xt” is entered as standard password.

Configuration with TELNET

IP Menu

```
Telnet 192.168.100.100
===== IP MENU =====
1 = IP - Address           = 192.168.100.100
2 = SubnetMask             = 255.255.0.0
3 = Standard Gateway      = 0.0.0.0
4 = Secondary Gateway     = 0.0.0.0
5 = IPv4 MulticastIP      = 0.0.0.0
6 = AutoIP (Y/N/A)       = A

a = IPv6 (Y/N)            = Y
b = IPv6 Address          =
c = IPv6 Prefix           = 64
d = IPv6 MulticastIP      =

For example: '1=192.168.10.10'
-----
[Q = QUIT] Please enter your choice:
```

- | | |
|------------------------------|---|
| 1 = IP – Address | With this item it is possible to change the IPv4 address.
<i>Example: 2=192.168.0.1</i> |
| 2 = SubnetMask | With this option it is possible to change the subnet mask.
<i>Example: 3=255.255.255.0</i> |
| 3 = Standard gateway | If a standard gateway is available or if you want to select a certain gateway, it is possible to enter this gateway here.
<i>Example: 8=192.168.0.25</i> |
| 4 = Secondary gateway | If an additional gateway is available, it can be entered here
<i>Example: 9=192.168.0.26</i> |
| 5 = IPv4 MulticastIP | If an IPv4 Multicast address is entered here, the interface is additionally accessible under this IP group address via UDP and it is a member of this IP group. |
| 6 = AutoIP (Y/N/A) | Activates or deactivates the AutoIP procedure.
Y = If the assigned IPv4 address (1) is between 169.254.1.0 and 169.254.254.255 it is being checked if the IPv4 address is already used and if so, an arbitrary new IPv4 address is created in this area.
N = Deactivated
A = In addition to (Y=), the standard IP address 192.168.100.100 assigned by AK-NORD is being checked. |
| a = IPv6 (Y/N) | IPv6 is activated (Y) or deactivated (N) |
| b = IPv6 Address | Manually assigned IPv6 address |
| c = IPv6 Prefix | Prefix of the manual IPv6 address |
| d = IPv6 MulticastIP | If here an IPv6 Multicast address is entered the interface is additionally accessible under this IP via UDP and it is a member of this IPv6 group. |

Configuration with TELNET

LPR Menu



```
Telnet 192.168.100.100
===== LPR MENU =====
1 = LPR (Y/N)           = Y
2 = LPR Port = 515

For example: '1=Y'
-----
[Q = QUIT] Please enter your choice:
```

1 = LPR (Y/N)

Using this item it is possible to activate or deactivate the LPR function

2 = LPR Port

With this option you can change the TCP/IP port (STANDARD = 515)

Configuration with TELNET

NTP Menu

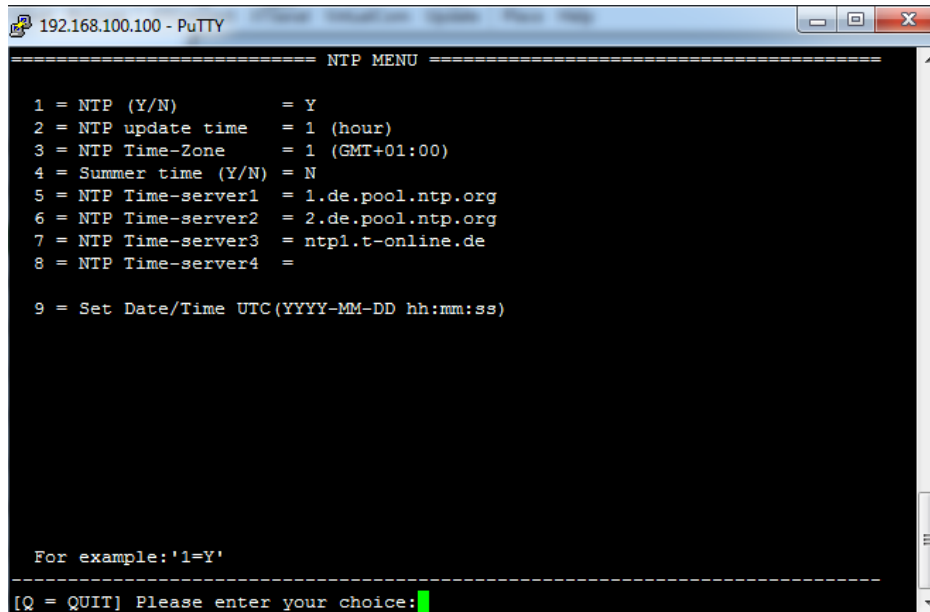

```
192.168.100.100 - PuTTY
----- NTP MENU -----
1 = NTP (Y/N)           = Y
2 = NTP update time    = 1 (hour)
3 = NTP Time-Zone      = 1 (GMT+01:00)
4 = Summer time (Y/N)  = N
5 = NTP Time-server1   = 1.de.pool.ntp.org
6 = NTP Time-server2   = 2.de.pool.ntp.org
7 = NTP Time-server3   = ntp1.t-online.de
8 = NTP Time-server4   =
9 = Set Date/Time UTC (YYYY-MM-DD hh:mm:ss)

For example: '1=Y'
-----
[Q = QUIT] Please enter your choice: █
```

- | | |
|------------------------------|--|
| 1 = NTP (Y/N) | Using this option it is possible to activate the NTP function. If this is enabled, the time is regularly synchrozed with an NTP server. |
| 2 = NTP update time | Time interval for queries in hours |
| 3 = NTP Time-Zone | Time zone for this device |
| 4 = Summer time (Y/N) | Summer time can be activated here |
| 5 = NTP Time-server1 | IP or hostname of an NTP Server |
| 6 = NTP Time-server2 | IP or hostname of an alternative NTP Server |
| 7 = NTP Time-server3 | IP or hostname of an alternative NTP Server |
| 8 = NTP Time-server4 | IP or hostname of an alternative NTP Server |
| 9 = Set Date/Time UTC | Here you can manually enter a date/time combination if you e.g. SSL certificates tested in the future or past.
Format : YYYY-MM-DD hh:mm:ss |
- Important: 1= NTP = Y must be activated.
This Option is only available from firmware version 2.0.2

Configuration with TELNET

POP3 menu

```
Telnet 192.168.100.100
===== POP3 MENU =====
1 = POP3 (Y/N)                = Y
2 = CHECK EMAIL                = 10 (min)
3 = POP3 SERVER                = pop3.provider.de
4 = USER                      = user@ak-nord.de
5 = PASSWORD                   = *****
6 = PORT                      = 110
7 = SSL/TLS option             = A (auto mode)

a = REPLY EMAIL (Y/N)         = Y
b = ONLY FORMAT                = TEXT
c = ONLY FROM                  =
d = ONLY SUBJECT               =
e = ONLY ATTACHMENT            =

Last State                    = NOT IN USE
                               Last Mail
From                           =
To                              =
Subject                         =
Date                           =
Attachment                     =

For example: '1=Y'
-----
[Q = QUIT] Please enter your choice:
```

- 1 = POP3 (Y/N)** Using this option it is possible to activate the POP3 function. If it is activated, the e-mails will be received by the POP e-mail inbox at an interval which is set under item 2 and the contents of the message of the e-mail is output at the indicated interface.
- 2 = CHECK EMAIL** The time interval at which e-mails are received
- 3 = POP3 SERVER** At this position the POP3 inbox server of your company or of your provider is entered.
Example: 3=pop-mail.t-online.de
- 4 = USER** Here you enter the user name and the password for the POP3 inbox access.
- 5 = PASSWORD** (with a few providers, the e-mail address is the same as the user name)
- 6 = PORT** The standard TCP port for POP3 is 110, thus it is in most cases not necessary to change it.
Possible ports are: 110,995
Only SXL Series.
A = depending on the used port.
1-3 (TLS1.0-1.2) in conjunction with Port 995
- 7 = SSL/TLS option**
- a = REPLY EMAIL (Y/N)** Using this option, it is possible to have confirmed each successfully processed e-mail message via the e-mail emulation. To do so, of course a mail outgoing account needs to be created under item "A" of the "NETWORK Menu" in the „SMTP Menu“.
- b = ONLY FORMAT** Here you can filter the format. Possible options are TEXT, HTML or ATTACHMENT. In doing so, it is determined which part of the e-mail is transmitted to the interface. One of the options needs to be indicated!
- c = ONLY FROM** This option allows to evaluate only e-mails of a certain sender
- d = ONLY SUBJECT** Here it is possible to indicate an additional filter for the reference line. This means, it is possible to indicate another "password" in addition to the control command "DEVICE=1" (1=interface 1), which can be defined in this option.
- e = ONLY ATTACHMENT** Using this option, it is possible to define the name of the attachment which needs to be evaluated. If there is no indication, all will be output.



NOTE:

Refer to application example: Email receipt (POP3)

Configuration with TELNET

SNMP Menu

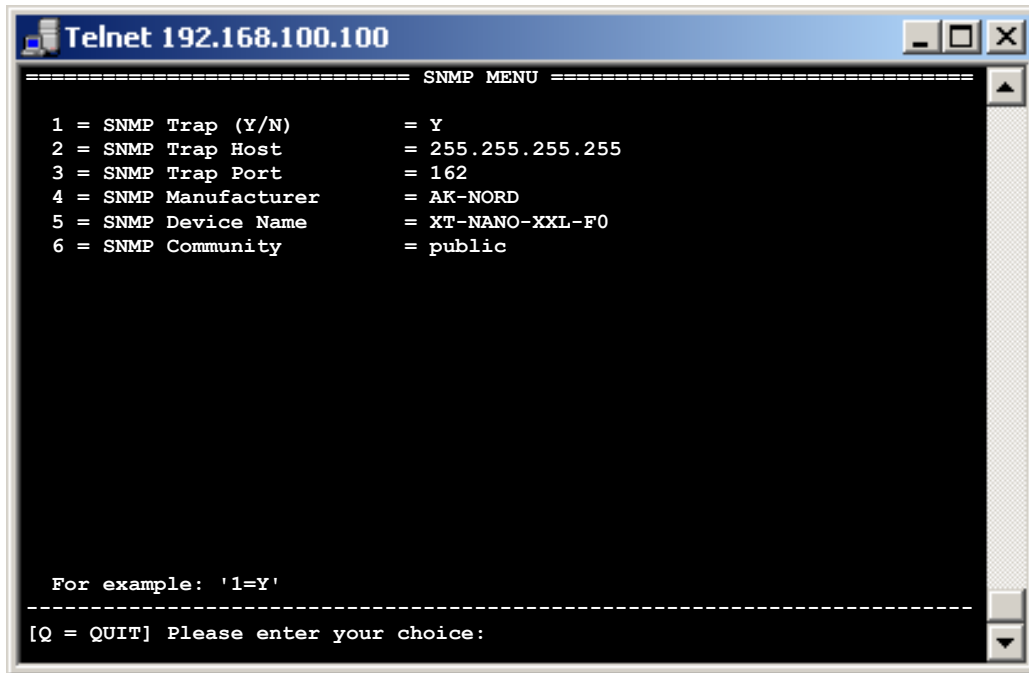

```
Telnet 192.168.100.100
===== SNMP MENU =====
1 = SNMP Trap (Y/N)           = Y
2 = SNMP Trap Host           = 255.255.255.255
3 = SNMP Trap Port           = 162
4 = SNMP Manufacturer        = AK-NORD
5 = SNMP Device Name         = XT-NANO-XXL-F0
6 = SNMP Community           = public

For example: '1=Y'
-----
[Q = QUIT] Please enter your choice:
```

- 1 = SNMP Trap (Y/N)
- 2 = SNMP Trap Host
- 3 = SNMP Trap Port

- 4 = SNMP Manufacturer
- 5 = SNMP Device Name
- 6 = SNMP Community

If you set this option, all released events are sent to an enterprise management system by SNMP-TRAP. It is possible to activate the single traps e.g. in the ALERT menus of the interfaces

Configuration with TELNET

SMTP Menu

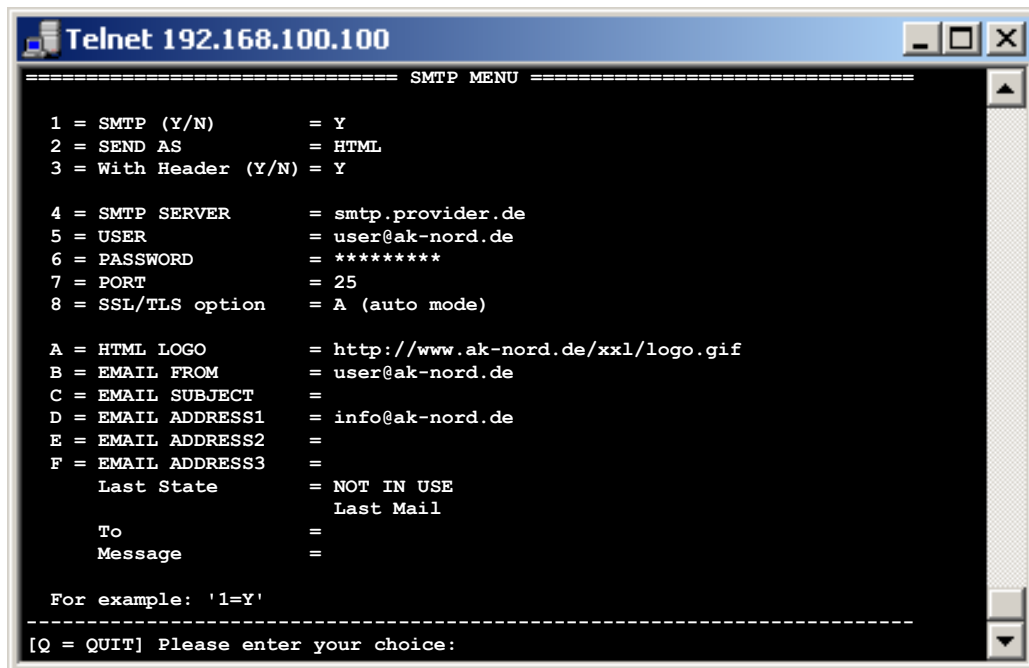

```
Telnet 192.168.100.100
===== SMTP MENU =====
1 = SMTP (Y/N)           = Y
2 = SEND AS              = HTML
3 = With Header (Y/N)   = Y

4 = SMTP SERVER          = smtp.provider.de
5 = USER                 = user@ak-nord.de
6 = PASSWORD             = *****
7 = PORT                 = 25
8 = SSL/TLS option       = A (auto mode)

A = HTML LOGO            = http://www.ak-nord.de/xxl/logo.gif
B = EMAIL FROM           = user@ak-nord.de
C = EMAIL SUBJECT        =
D = EMAIL ADDRESS1       = info@ak-nord.de
E = EMAIL ADDRESS2       =
F = EMAIL ADDRESS3       =
  Last State              = NOT IN USE
                        Last Mail
  To                      =
  Message                 =

For example: '1=Y'
-----
[Q = QUIT] Please enter your choice:
```

- | | |
|------------------------------|--|
| 1 = SMTP (Y/N) | Using this function it possible to activate or deactivate the SMTP function |
| 2 = SEND AS | Using this option, you determine in which format the e-mail will be sent. You can choose among TEXT, HTML or ATTACHMENT |
| 3 = With Header (Y/N) | With or without sender information. |
| 4 = SMTP SERVER | At this position the SMTP server of your company or of your provider is entered.
<i>Example: 3=asmtt.t-online.de</i> |
| 5 = USER | Here you enter the user name and the password for the SMTP access. |
| 6 = PASSWORD | (with a few providers the e-mail address is same as the user name) |
| 7 = PORT | The standard TCP port for SMTP is 25 and thus it does not need to be changed in most cases. Possible ports are: 25,465,587 |
| 8 = SSL/TLS option | Only SXL Series.
A = depending on the used port.
1-3 (START TLS1.0-1.2) in conjunction with Port 587
4-6 (DIRECT TLS1.0-1.2) in conjunction with Port 465 |
| A = HTML LOGO | At this positions it is possible to exchange the logo for the e-mails in the HTML format by entering a HTTP:// address, which is directly linked to e.g.a logo file |
| B = EMAIL FROM | Here you define the sender address. |
| C = EMAIL SUBJECT | Using this option, you can enter your proper reference. The following will be used as standard reference line.
<i>Example: XT-NANO-XXL-03A000 alert message from:192.168.100.100</i> |
| D = EMAIL ADDRESS1 | Here you can enter 3 e-mail recipients. |
| E = EMAIL ADDRESS2 | |
| F = EMAIL ADDRESS3 | |

Configuration with TELNET

TFTP Menu

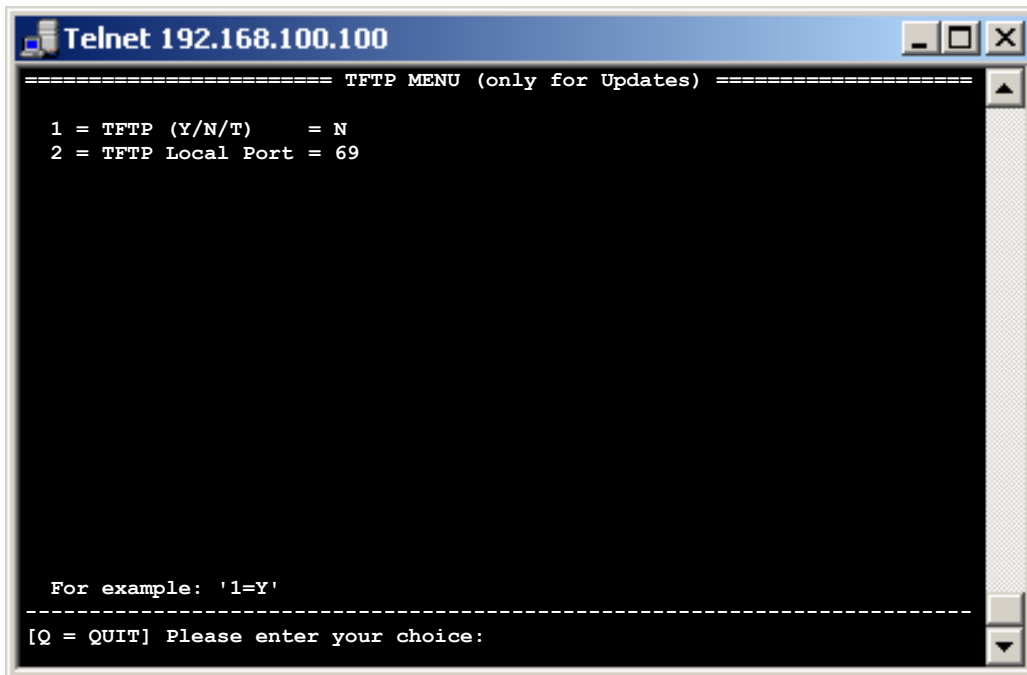

```
Telnet 192.168.100.100
==== TFTP MENU (only for Updates) =====
1 = TFTP (Y/N/T) = N
2 = TFTP Local Port = 69

For example: '1=Y'
-----
[Q = QUIT] Please enter your choice:
```

1 = TFTP (Y/N/T)

Using this function you can activate, deactivate or temporarily set the TFTP function.

2 = TFTP Local Port

The standard TCP port for TFTP is 69 and thus it is not necessary to change it in most cases



NOTE:

The TFTP function is only provided for network firmware updates and not to transfer data using the interface. If the port is changed, it is no longer possible to use the update function of XT-ADMIN.

Configuration with TELNET

TCP Menu

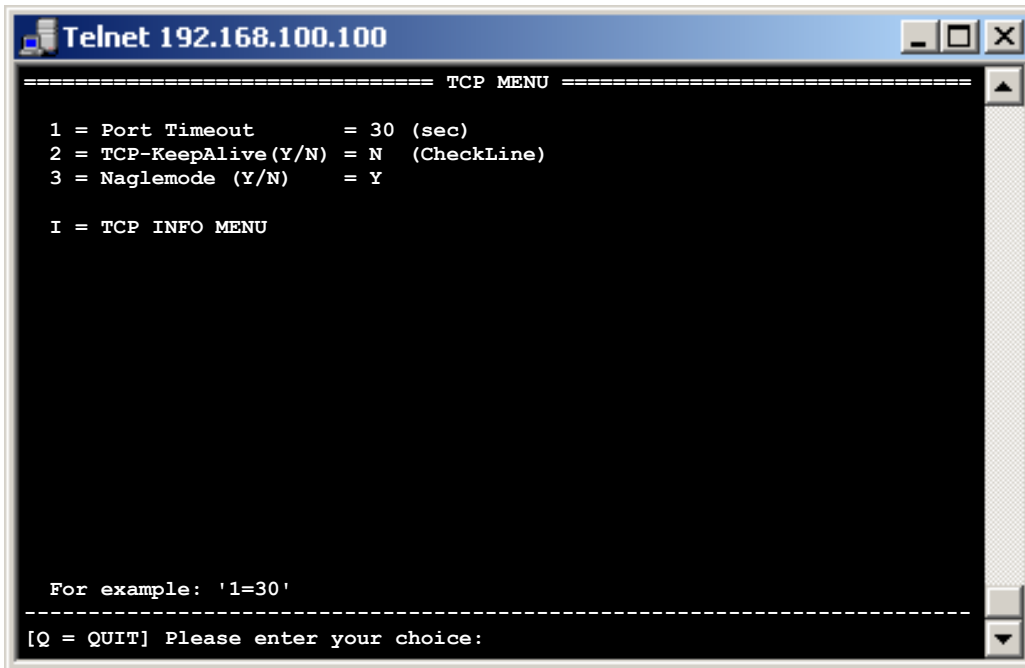

```
Telnet 192.168.100.100
==== TCP MENU ====
1 = Port Timeout      = 30 (sec)
2 = TCP-KeepAlive(Y/N) = N (CheckLine)
3 = Naglemode (Y/N)  = Y

I = TCP INFO MENU

For example: '1=30'
-----
[Q = QUIT] Please enter your choice:
```

- | | |
|-------------------------------|---|
| 1 = Port Timeout | Determines when an inactive connection needs to be terminated, entry in seconds.
<i>Example: 7=25</i>
<i>Porttimeout = 0 deactivates the Porttimeout.</i> |
| 2 = TCP-KeepAlive(Y/N) | If this function is activated, the interface will check if there is a target connection. If the PC had been switched off, the port timeout runs automatically (NETWORK-MENU → IP MENU) and the interface terminates the connection when the period of time has elapsed and then will immediately try to establish a new connection. |
| 3 = Naglemode (Y/N) | If you select 3=Y, no additional ACK package will be sent after having sent the data package. However it will cause that the connection partner will possibly wait for 200 ms until the package is transferred to the application
<i>Example: 3=N</i> |
| I = TCP INFO MENU | At this position it is possible to view the TCP connections and their statuses. |

Configuration with TELNET

TCP INFO Menu

```
Telnet 192.168.100.100
===== TCP INFO MENU =====
-----
Port  State      Type  Appl.  CL ->Port  IP
-----
23    CONNECTED    SERVER TELNET  N   1085    192.168.23.251
-----

For example : 'N' (Next) 'B' (Back) '+' (All) '-' (Active)
-----
[Q = QUIT] Please enter your choice:
```

State

CONNECTED

Explanation

Connected means that the connection is established. Incoming as well as outgoing connection are displayed. They are distinguished in the column "Type". SERVER means incoming connections and CLIENT means outgoing connections.

**ARPRESOLVING
DNSRESOLVING**

These entries had been requested via the DNS server, but they had not yet been responded. The same applies for ARP requests, they had been sent to the network but not yet responded.

LISTENING

TCP ports waiting for incoming connections.
Will only be listed for the activation of the <ALL> display. In order to activate the <ALL> display, enter a "+"

Configuration with TELNET

UDP Menu

```

Telnet 192.168.100.100
===== UDP MENU =====
1 = Port Timeout      = 30 (sec)
I = UDP INFO MENU

For example: '1=30'
-----
[Q = QUIT] Please enter your choice:
  
```

1 = Port Timeout

Determine when an inactive connection needs to be terminated, input in seconds.
Example: 7=25
Porttimeout = 0 deactivates the Porttimeout.

I = UDP INFO MENU

Using this option you can view the UDP connections and their statuses.

```

Telnet 192.168.100.100
===== UDP INFO MENU=====
-----
Port  State      Type  Appl.  ->Port  IP
-----
68    OPENED    CLIENT DHCP   0      0.0.0.0
1501  OPENED    CLIENT DNS   0      0.0.0.0
161   OPENED    SERVER SNMP  0      0.0.0.0
1002  CONNECTED CLIENT UDP-CNT 2000   255.255.255.255
-----

For example: 'N' (Next) 'B' (Back) '+' (All) '-' (Active)
-----
[Q = QUIT] Please enter your choice:
  
```

State

CONNECTED

Explanation

Connected means that the connection is established. Incoming as well as outgoing connection are displayed. They are distinguished in the column "Type". SERVER means incoming connections and CLIENT means outgoing connections.

OPENED

UDP ports waiting for incoming connections

FREE

A free space for a possibly additional UDP connection. (Will only be listed for the activation of the <ALL> display. In order to activate the <ALL> display, enter a "+")

Configuration with TELNET

Configuring AK-XXL products

DISK-DRIVE MENU

Configuration with TELNET

DISK-DRIVE-MENU

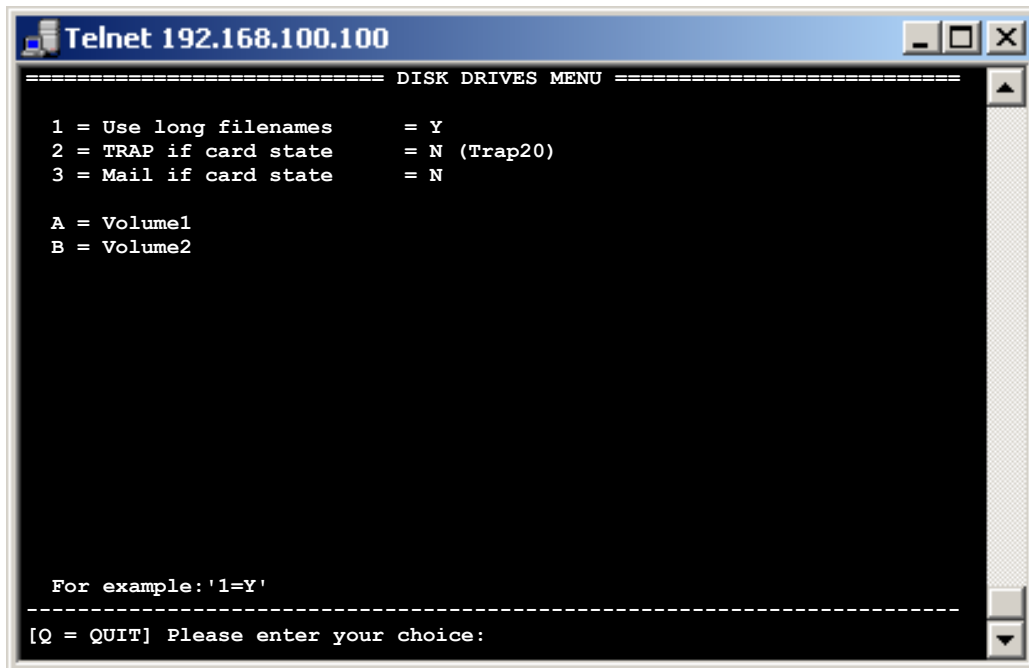

```
Telnet 192.168.100.100
===== DISK DRIVES MENU =====
1 = Use long filenames           = Y
2 = TRAP if card state          = N (Trap20)
3 = Mail if card state          = N

A = Volume1
B = Volume2

For example: '1=Y'
-----
[Q = QUIT] Please enter your choice:
```

1 = Use long filenames

If this function is switched off, the AK-XXL product only supports file and directory names which are shorter than 8 characters.

2 = TRAP if card state

Here it is possible to notify the inserting or removing of a memory card by means of an SNMP TRAP. In order to use the function, the SNMP (NETWORK MENU → SNMP MENU) needs to be activated.

3 = Mail if card state

Using this function an e-mail will be sent if a memory card is added or removed. In order to allow this, a server and a recipient needs to be set in the SMTP menu.

A = Volume1 B = Volume2

Using these menus, detailed information regarding the memory cards are displayed. In addition it is also possible to delete or completely format the memory cards. VOLUME1 is always available and represents a minimum FLASH memory in order to load e.g. a configuration file.

Configuration with TELNET

VOLUME MENU

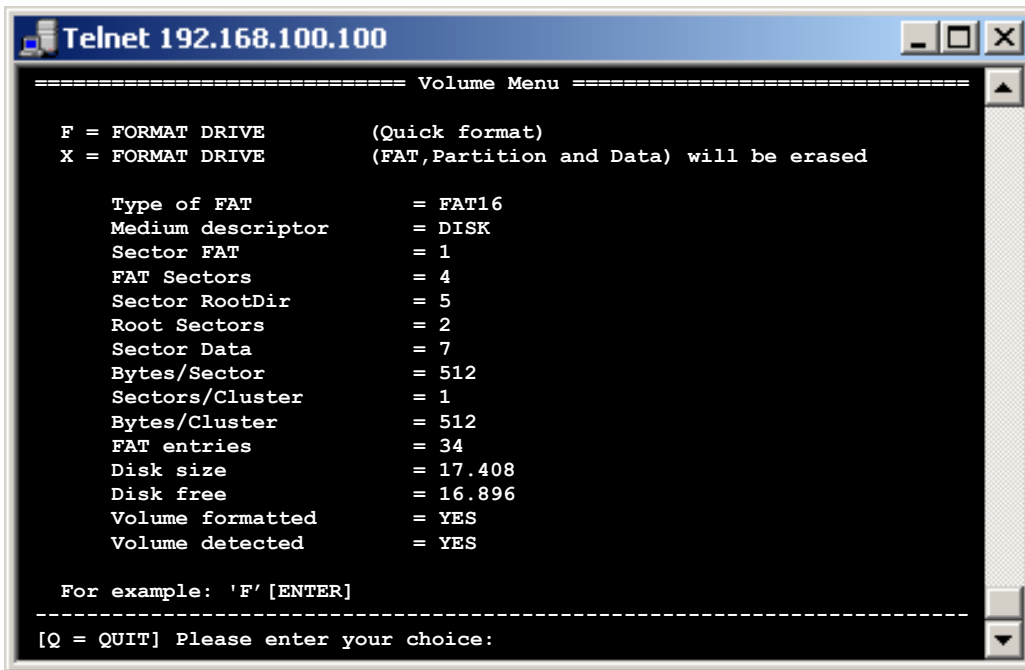

```
Telnet 192.168.100.100
===== Volume Menu =====
F = FORMAT DRIVE          (Quick format)
X = FORMAT DRIVE          (FAT, Partition and Data) will be erased

Type of FAT                = FAT16
Medium descriptor          = DISK
Sector FAT                 = 1
FAT Sectors                = 4
Sector RootDir             = 5
Root Sectors               = 2
Sector Data                = 7
Bytes/Sector               = 512
Sectors/Cluster            = 1
Bytes/Cluster              = 512
FAT entries                = 34
Disk size                  = 17.408
Disk free                  = 16.896
Volume formatted           = YES
Volume detected            = YES

For example: 'F' [ENTER]
-----
[Q = QUIT] Please enter your choice:
```

F = FORMAT DRIVE
(Quick format)

Here all data will be deleted from the memory

X = FORMAT DRIVE

Using this function, the memory will be completely reinitialized

All other data are intended for error analysis.

Configuration with TELNET

Configuring AK-XXL products

INTERFACE MENU

Configuration with TELNET

SERIAL Menu

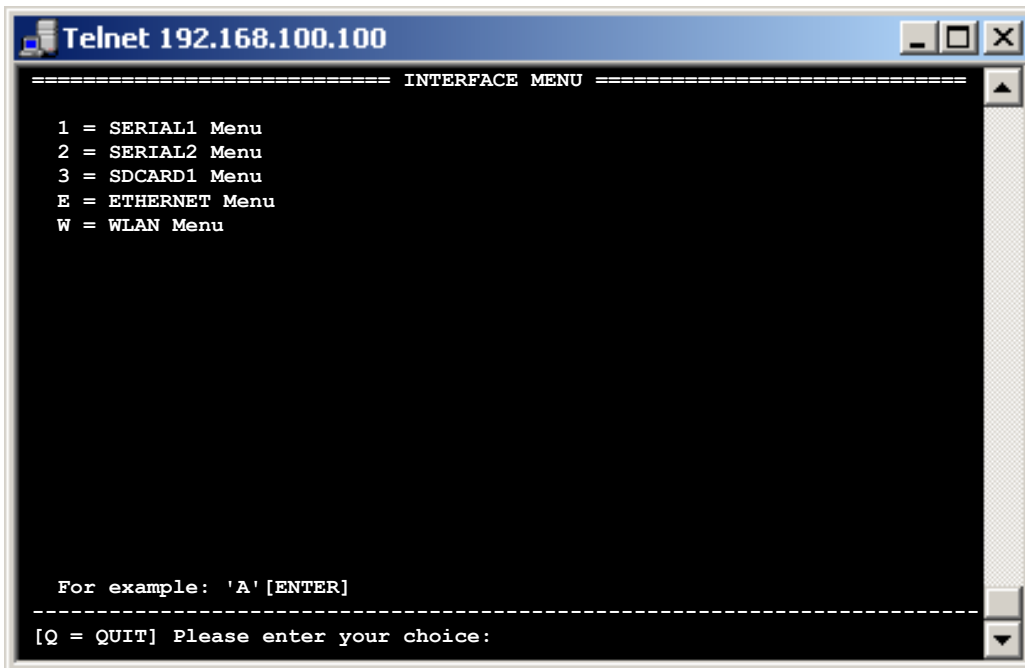

The menus are dynamic. This means, that the menu names will adapt themselves to the selected BUS. It is possible to select the BUS in the submenu of these two menus.

The number of menus varies depending on how many physical interfaces are available on the product. As described in the above example of a COMPOINT-XXL there are two serial interfaces and a SDCARD interface. For a CONLINE-V24 accordingly only the “SERIAL1 Menu” and the “ETHERNET Menu” would be listed.

Please find the BUS variants which you can choose in the following table.

The menus of the different bus types are described below.

Please find detailed information regarding the BUS variants SPI, I2C, LCD, SDC and DFC in the [DesignGuide of the XT-NANO-XXL or XT-PICO-XXL](#).

You can set the MAC address and the Ethernet speed in the “ETHERNET Menu”.

Interface / BUS	XT-NANO-XXL/SXL	XT-PICO-XXL/SXL	COMPOINT-XXL/SXL	COMPOINT-XXR	MICRO-C-SXL
ETHERNET	X	X	X	X	
WLAN				X	
RS232	X	X	X	X	
RS485	X	X	X	X	
SPI	X	X			
I2C	X	X			
LPT					X
WIEGAND	X	X			
TTL-IO (no data transfer / lines can be switched HIGH/LOW)	X	X			
LCD (controlling the LCD display via SPI)	X	X			
SDC (controlling the SD cards via SPI)	X	X			
DFC (controlling the SD cards via SPI)	X	X			

Configuration with TELNET

Configuring AK-XXL products

BUS TYPE RS232 and RS485, INTERFACE MENU

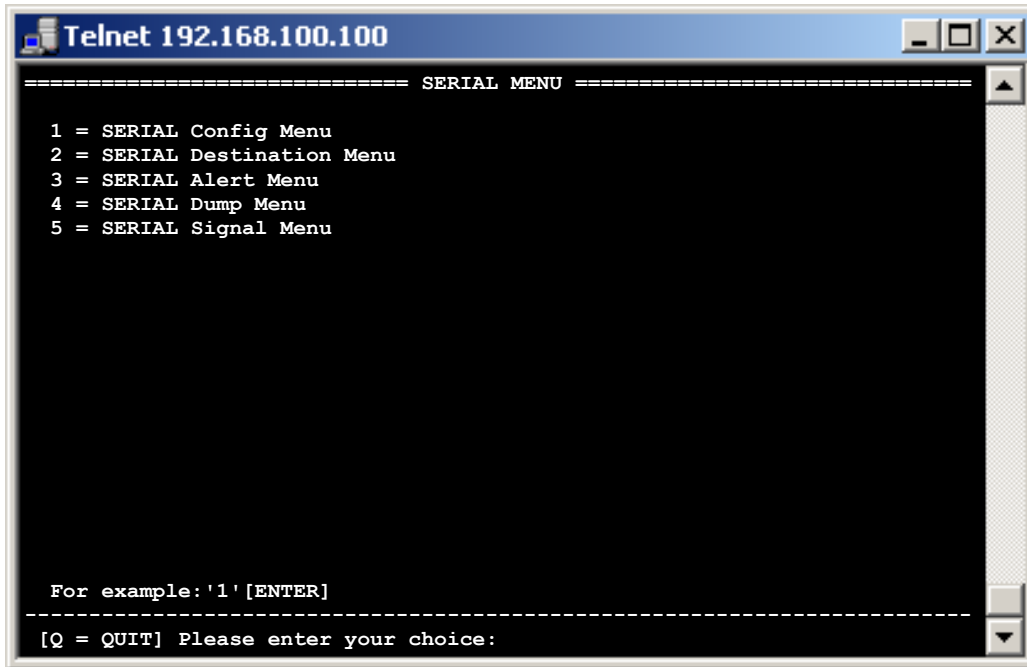

```
Telnet 192.168.100.100
===== SERIAL MENU =====
1 = SERIAL Config Menu
2 = SERIAL Destination Menu
3 = SERIAL Alert Menu
4 = SERIAL Dump Menu
5 = SERIAL Signal Menu

For example: '1' [ENTER]
-----
[Q = QUIT] Please enter your choice:
```

- | | |
|------------------------------------|---|
| 1 = SERIAL Config Menu | With this option it is possible to change the configuration of the interface. |
| 2 = SERIAL Destination Menu | In the Destination Menu you can enter one or several targets to which the data can be automatically sent. |
| 3 = SERIAL Alert Menu | In this menu it is possible to release event messages which can be sent by SNMP or by e-mail. |
| 4 = SERIAL Dump Menu | In the Dump menu you can have displayed the data which the serial interface has received. It serves for the error analysis. |
| 5 = SERIAL Signal Menu | Here the status of the single signal lines is displayed. |



Note:

Quit the menu by entering q for “quit“. All written values will be initialized upon entry and can be used then.

Configuration with TELNET

Configuring AK-XXL products

BUS TYPE RS232 and RS485, SERIAL Config Menu

```
Telnet 192.168.100.100
===== SERIAL Config Menu =====
1 = Baudrate           = 9600
2 = Databits           = 8
3 = Parity             = N
4 = Stopbits           = 1
5 = Flow Control       = N
6 = RTS Protocol       = 0
7 = DCD Protocol       = 0
8 = DTR Protocol       = 0
9 = DSR Protocol       = 0

a = Emulation          = TCPSERVER
b = EmuCode            = 0000
c = BUS                = RS485
d = InputTimeOut*10ms  = 0
e = Local Port         = 1002
f = Local SSL Port     = 0

STATE=HW ONLINE

For example: '1=9600'
-----
[Q = QUIT] Please enter your choice:
```

- 1=Baudrate:** Enter the baud rate of your terminal.
The baud rate can be variably set from 1 to 1000000.
Standard baud rates would be e.g.: 300, 600, 1200, 2400, 4800, 9600, 19200, 38400, 57600, 115200
Input example: 1=9600
- 2=Databits:** Enter the number of your data bits. It is possible to set the following data bits:
7, 8
Input example: 2=8
- 3=Parity:** ODD = O, EVEN = E, M=MARK, S=SPACE, N=NONE
Example: 3=E
- 4=Stopbits:** Number of the stop bits, 1,2
Example: 4=1
- 5=FlowControl** Switches the flow control on or off. H = Hardware, S = Software, N = None
Example: 5=H
- 6=RTS Protocol:** Select the behavior of the RTS line (output) with this menu item
6=0 → RTS Always ON
6=1 → RTS Follows CTS
6=2 → RTS Follows DSR
6=3 → RTS Indicates Connection TTL = LOW, V24 = HIGH
6=4 → RTS Indicates Connection TTL = HIGH, V24 = LOW
6=5 → RTS Always OFF
- 7=DCD Protocol:** This menu item selects the behavior of the DCD line (output)
no function
- 8=DTR Protocol:** This menu item selects the behavior of the DTR line (output)
8=0 → DTR Always ON
8=1 → DTR Indicate Connection TTL = LOW, V24 = HIGH
8=2 → DTR Follows DSR
8=3 → DTR Indicate Connection TTL = HIGH, V24 = LOW
8=5 → DTR Always OFF
- 9=DSR Protocol:** This menu item selects the behavior of the DSR line (input)
9=0 → DSR No Control
9=1 → DSR Control Incoming
9=2 → DSR Clear Connection
9=3 → DSR Control Incoming und DSR Clear Connection

Configuration with TELNET

Configuring AK-XXL products

BUS TYPE RS232 and RS485, SERIAL Config Menu

```
Telnet 192.168.100.100
===== SERIAL Config Menu =====
1 = Baudrate           = 9600
2 = Databits           = 8
3 = Parity              = N
4 = Stopbits           = 1
5 = Flow Control       = N
6 = RTS Protocol       = 0
7 = DCD Protocol       = 0
8 = DTR Protocol       = 0
9 = DSR Protocol       = 0

a = Emulation          = TCPSERVER
b = EmuCode            = 0000
c = BUS                = RS485
d = InputTimeOut*10ms = 0
e = Local Port         = 1002
f = Local SSL Port     = 0

STATE=HW ONLINE

For example: '1=9600'
-----
[Q = QUIT] Please enter your choice:
```

a=Emulation:

It is possible to use the following emulations:

Modem emulation	Input:	a=MODEM
EMAIL	Input:	a=EMAIL
TCPCLIENT	Input:	a=TCPCLIENT
UDPCLIENT	Input:	a=UDPCLIENT
UDPSERVER	Input:	a=UDPSERVER
No emulation	Input:	a=TCPSERVER

b=Emucode:

Using this menu item it is possible to release customized functions.

c=BUS

Here it is possible to enter the BUS types indicated on page 38
RS232, RS485
ONLY for XT-NANO/PICO-XXL → SPI, I2C, TTL-IO, SDC, DFC, LCD.

d = InputTimeOut*10ms:

Determines how long the interface shall wait until incoming data are being sent. This value is important if the packages are not completely received at the target since the data are more rapidly sent into the network from the interface than from the terminal to the AK-XXL product. In our example the value is set to 30. This way, the interface will wait 300 ms after having received the last byte on the serial interface and will only then send the package.

Example: 9=30 (Timeout to 300ms)

e = Local Port:

Here it is possible to define the TCP/IP or UDP port which is admitted for the corresponding serial interface. If you enter 23 (Telnet) or 80 (browser) then it is no longer possible to configure the device via this service, but the data (requests) from the browser or Telnet will be directly output via the serial interface.

f = Local SSL Port:

Has got the same function as the local port, but this port is only used for the encrypted SSL communication

Configuration with TELNET

Configuring AK-XXL products

BUS TYPE RS232 and RS485, SERIAL Destination Menu

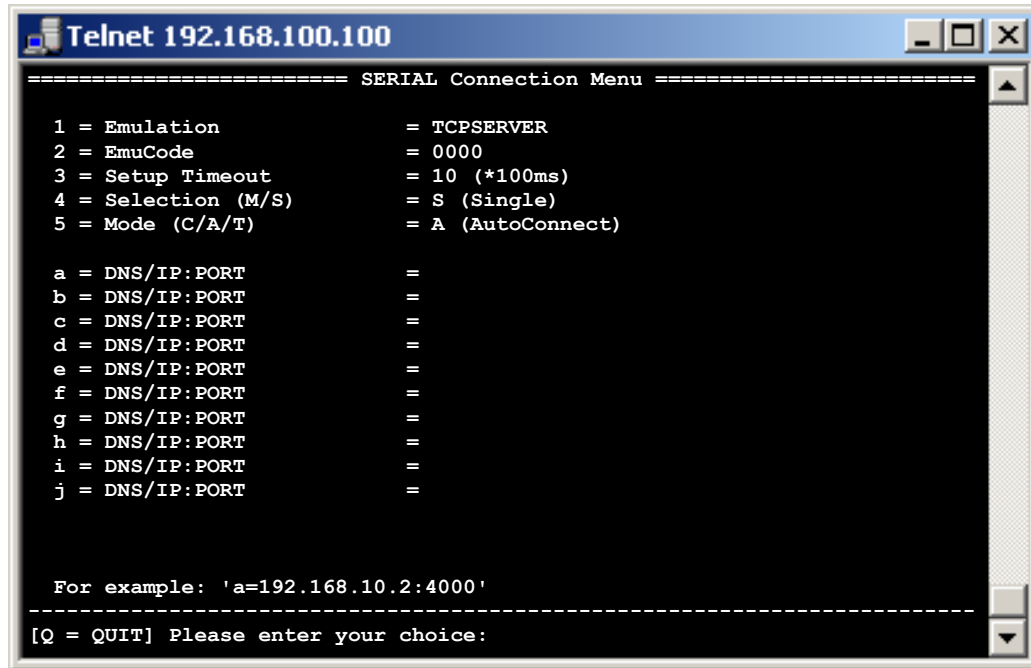

- | | |
|--|---|
| 1 = Emulation | This is the same option as in the Serial Config Menu |
| 2 = EmuCode | This is the same option as in the Serial Config Menu |
| 3 = Setup Timeout | Determines how long it is being tried to establish a connection to the target if the target is not immediately available
<i>Example: 3=10</i> |
| 4 = Selection (M/S) | With this option you can choose between the connection types SINGLE and MULTI. SINGLE means that the data are being transmitted to the first target which is listed, if this target is available. Otherwise, it is being tried to connect to the second target and then to the third one, etc. The Setup Timeout determines for how long it is being tried to establish a connection to the corresponding target. In the menu type MULTI the data will be transmitted to all targets at the same time.
<i>Example: 4=M</i> |
| 5 = Mode (C/A/T) | With this option you can select the operating mode. It influences the mode only for the emulations TCP and UDPCLIENT. The peculiarities of the single options are described in the chapter "Emulations (operating modes)".
<i>Example: 5=C</i> |
| a = DNS/IP:PORT | Determine the 1 st target address (IP or DNS) and the first TARGET PORT, if you use the TCP or UDPCLIENT emulation. The TARGET address and TARGET PORT are separated by a double point.
All data which are incoming on the serial interface are automatically sent to the entered target.
<i>Example: a=192.168.0.2:6000</i> |
| b = DNS/IP:PORT
c = DNS/IP:PORT
d = DNS/IP:PORT
e = DNS/IP:PORT
f = DNS/IP:PORT
g = DNS/IP:PORT
h = DNS/IP:PORT
i = DNS/IP:PORT
j = DNS/IP:PORT | Using the options "b" through "j" it is possible to determine further TARGET addresses. In the MULTI mode all addresses will be opened at the same time and the data will be sent. It is possible to operate up to 10 targets at the same time. In the SINGLE mode, the other TARGETS are addressed one after another, if the first one is not available. |

Configuration with TELNET

Configuring AK-XXL products

BUS TYPE RS232 and RS485, SERIAL Alert Menu

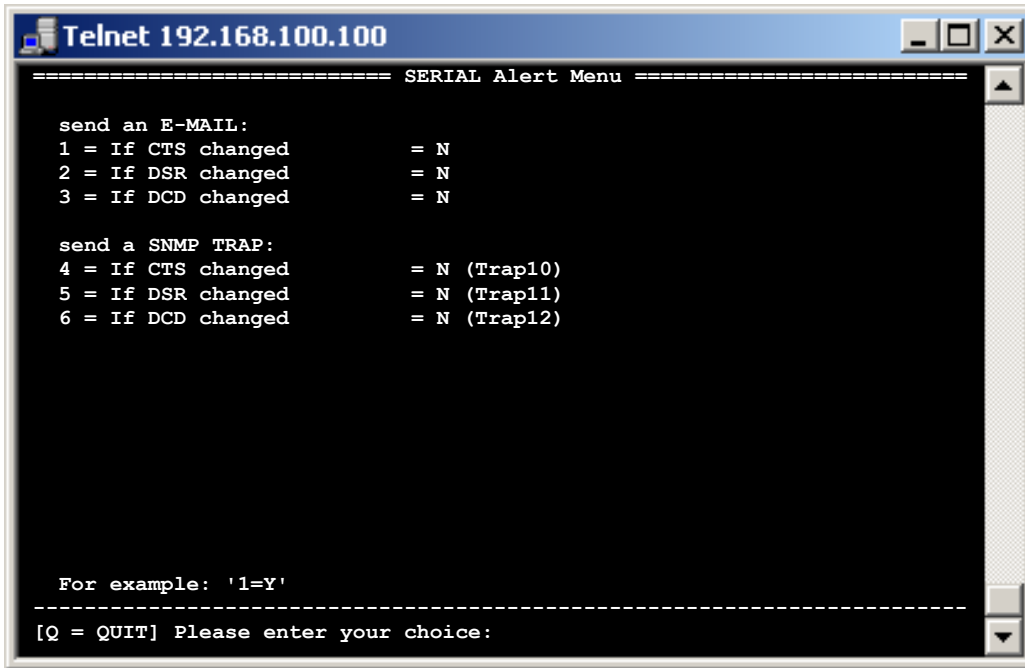

```
Telnet 192.168.100.100
===== SERIAL Alert Menu =====
send an E-MAIL:
1 = If CTS changed           = N
2 = If DSR changed           = N
3 = If DCD changed           = N

send a SNMP TRAP:
4 = If CTS changed           = N (Trap10)
5 = If DSR changed           = N (Trap11)
6 = If DCD changed           = N (Trap12)

For example: '1=Y'
-----
[Q = QUIT] Please enter your choice:
```

send an E-MAIL:

- 1 = If CTS changed
- 2 = If DSR changed
- 3 = If DCD changed

If the target data are correctly entered in the SMTP menu and if the SMTP function had been activated, an e-mail will be sent to the entered recipients if the different events are occurring.

send a SNMP TRAP:

- 4 = If CTS changed (Trap10)
- 5 = If DSR changed (Trap11)
- 6 = If DCD changed (Trap12)

If the SNMP traps are activated in the SNMP menu, SNMP traps are sent to the set servers for the described events.

Configuration with TELNET

Configuring AK-XXL products

BUS TYPE RS232 and RS485, SERIAL Alert Menu

```
Telnet 192.168.100.100
===== SERIAL Dump Menu =====
RX
00 00 00 00 00 00 00 00 00 00 00 00 00 00 00 00 .....
00 00 00 00 00 00 00 00 00 00 00 00 00 00 00 00 .....
00 00 00 00 00 00 00 00 00 00 00 00 00 00 00 00 .....
00 00 00 00 00 00 00 00 00 00 00 00 00 00 00 00 .....
00 00 00 00 00 00 00 00 00 00 00 00 00 00 00 00 .....
00 00 00 00 00 00 00 00 00 00 00 00 00 00 00 00 .....
00 00 00 00 00 00 00 00 00 00 00 00 53 45 52 49 41 .....SERIA
4C 2D 49 4E 50 55 54 2D 31 32 33 2D 54 45 53 54 L-INPUT-123-TEST<--

TX
00 00 00 00 00 00 00 00 00 00 00 00 00 00 00 00 .....
00 00 00 00 00 00 00 00 00 00 00 00 00 00 00 00 .....
00 00 00 00 00 00 00 00 00 00 00 00 00 00 00 00 .....
00 00 00 00 00 00 00 00 00 00 00 00 00 00 00 00 .....
00 00 00 00 00 00 00 00 00 00 00 00 00 00 00 00 .....
00 00 00 00 00 00 00 00 00 00 00 00 4E 45 54 57 4F 52 .....NETWOR
4B 2D 49 4E 50 55 54 2D 31 32 33 2D 54 45 53 54 K-INPUT-123-TEST<--

-----
[Q = QUIT] Please enter your choice:
```

Under RX data are displayed which had been received via their serial interface.
For TX data will be displayed which had been received via the network for the interface.

Configuration with TELNET

Configuring AK-XXL products

BUS TYPE RS232 and RS485, SERIAL Alert Menu

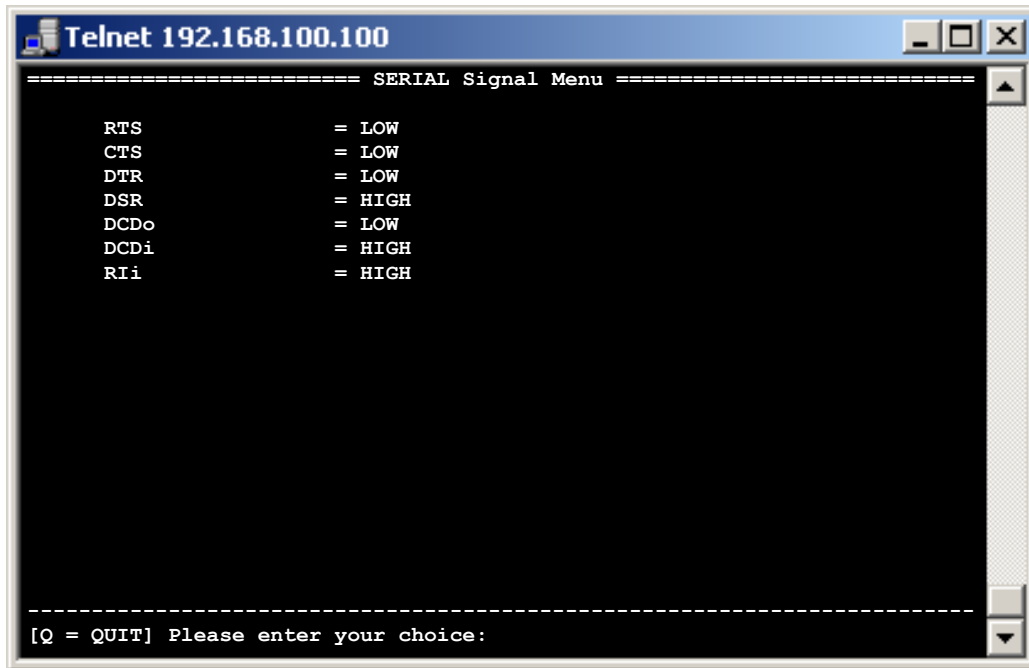

The screenshot shows a Telnet window titled "Telnet 192.168.100.100". The main content is a "SERIAL Signal Menu" with the following configuration:

```
===== SERIAL Signal Menu =====  
  
RTS           = LOW  
CTS           = LOW  
DTR           = LOW  
DSR           = HIGH  
DCDo         = LOW  
DCDi         = HIGH  
RIi         = HIGH  
  
-----  
[Q = QUIT] Please enter your choice:
```

Configuration with TELNET

SDCARD Menu

SDCARD1 Menu, SDC Config Menu

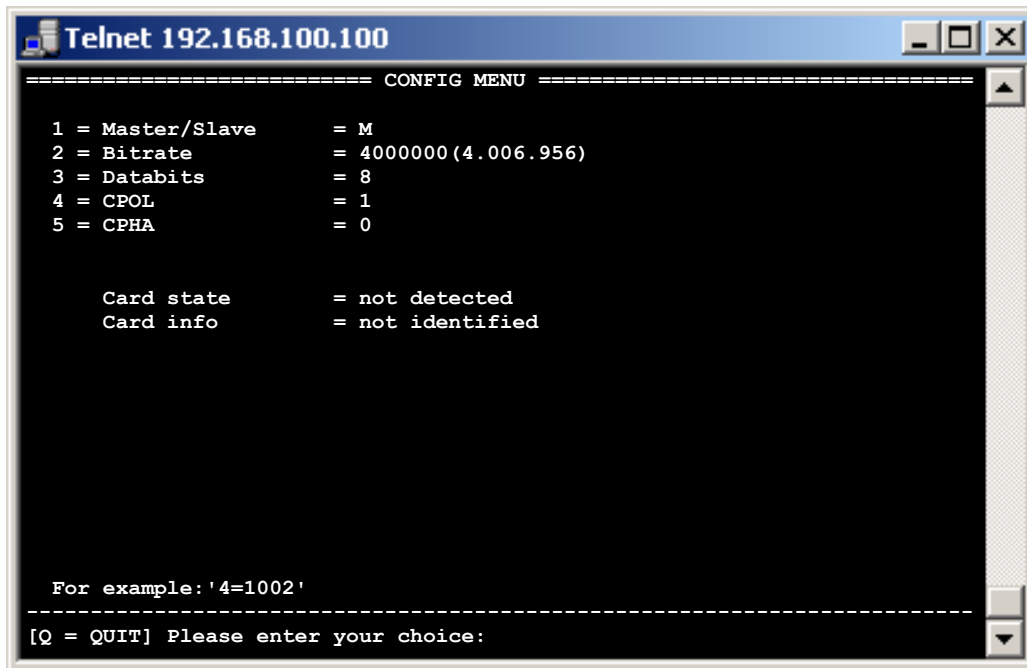

```
Telnet 192.168.100.100
===== CONFIG MENU =====
1 = Master/Slave      = M
2 = Bitrate           = 4000000 (4.006.956)
3 = Databits          = 8
4 = CPOL              = 1
5 = CPHA              = 0

Card state           = not detected
Card info            = not identified

For example: '4=1002'
-----
[Q = QUIT] Please enter your choice:
```

All values are preset and are compliant with most cards.

1 = Master/Slave = An SD card / DF card can only be operated in the master mode

2 = Bitrate = Bit rate on the SPI bus. Possible values from 1 -25.000.000bit/s



The most cards can be operated at a speed of 4Mbit.

3 = Databits = Possible values 8

4 = CPOL = Clock Polarity possible values 0,1

5 = CPHA = Clock Phase possible values 0,1

Configuration with TELNET

WIEGAND Menu

WIEGAND1 Menu, WIEGAND Config Menu

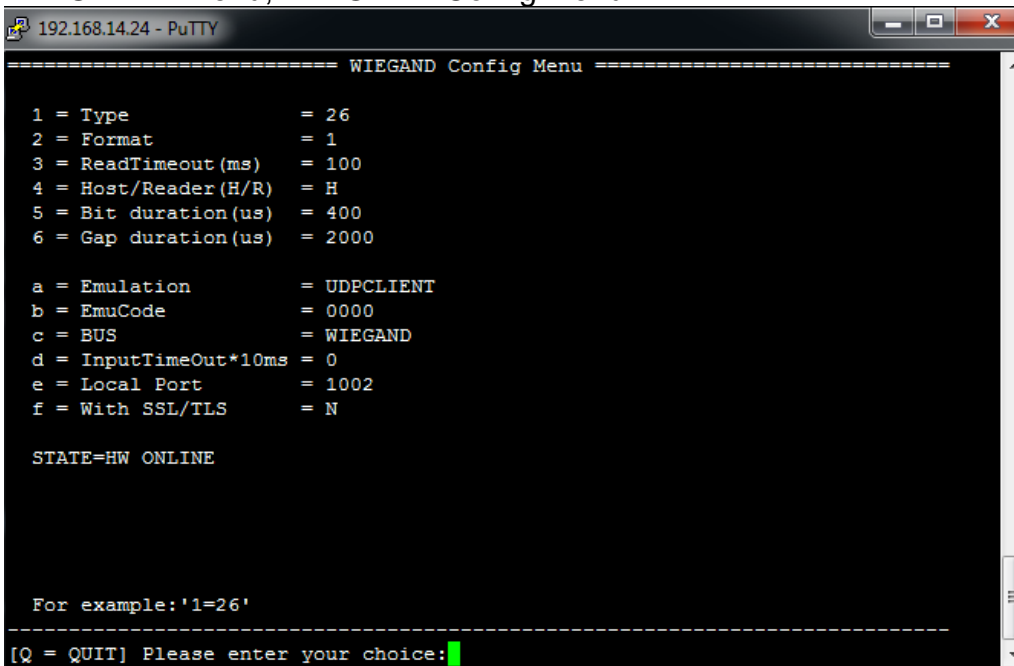

```
192.168.14.24 - PuTTY
===== WIEGAND Config Menu =====
1 = Type           = 26
2 = Format         = 1
3 = ReadTimeout(ms) = 100
4 = Host/Reader(H/R) = H
5 = Bit duration(us) = 400
6 = Gap duration(us) = 2000

a = Emulation      = UDPCCLIENT
b = EmuCode       = 0000
c = BUS           = WIEGAND
d = InputTimeOut*10ms = 0
e = Local Port    = 1002
f = With SSL/TLS  = N

STATE=HW ONLINE

For example: '1=26'

-----
[Q = QUIT] Please enter your choice: █
```

- 1 = Type :** 26=Wiegand 26 (24 Bit Data + 2 Bit Parity)
34=Wiegand 34 (32 Bit Data + 2 Bit Parity)
- 2 = Format :** 0 (MSB first, FIFO)
1 (LSB first, FIFO)
2 (LSB first LIFO)
3 (MSB first, LIFO)
4 (Decimalvalue of Facility and Decimalvalue of Card-ID)
- 3 = ReadTimeout(ms) :** Duration while a reader must have transferred all bits.
If the data is not completely transferred within this duration, these will be discarded
- 4 = Host/Reader(H/R) :** H=host mode, a Wiegand reader is connected, which delivers the data. This data is then transmitted over network
R=reader mode, in this Mode device received over network 3 or 4 bytes, generates the parity bits for this data and transmits the data via Wiegand data lines(D0,D1)
- 5 = Bit duration(us) :** Only in reader mode, duration of a data bit
- 6 = Gap duration(us) :** Only in reader mode, duration of a gap between two data bis
- a = Emulation :** This is the same Option like in Serial Config Menü
- b = EmuCode :** Customized function Code's
- c = BUS :** Bus type see Page 38
Wicon-SXL only allowed WIEGAND
- d = InputTimeOut*10ms:** Wait this duration after last Data byte before this data is transmitted via network
- e = Local Port:** Here you can define the TCP or UDP port approved for this interface
- f = With SSL/TLS:** Y = SSL communication is used and the data is encrypted see SSL configuration
N = Normal communication without encryption

Configuration with TELNET

LPT Menu

LPT1 Menu, LTP Config Menu

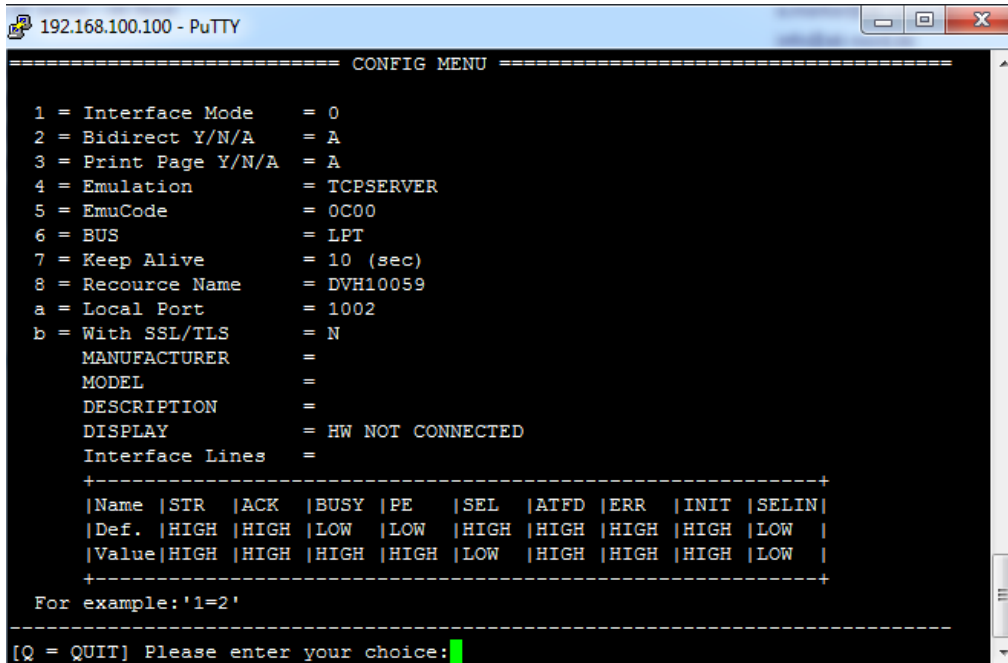

```
----- CONFIG MENU -----
1 = Interface Mode      = 0
2 = Bidirect Y/N/A     = A
3 = Print Page Y/N/A   = A
4 = Emulation          = TCPSERVER
5 = EmuCode            = 0C00
6 = BUS                = LPT
7 = Keep Alive         = 10 (sec)
8 = Recource Name      = DVH10059
a = Local Port         = 1002
b = With SSL/TLS       = N
MANUFACTURER          =
MODEL                 =
DESCRIPTION            =
DISPLAY               = HW NOT CONNECTED
Interface Lines       =
+-----+
|Name |STR |ACK |BUSY |PE  |SEL |ATFD |ERR |INIT |SELIN|
|Def. |HIGH|HIGH|LOW  |LOW  |HIGH|HIGH |HIGH|HIGH |LOW  |
|Value|HIGH|HIGH|HIGH |HIGH |LOW  |HIGH |HIGH |HIGH |LOW  |
+-----+
For example: '1=2'
-----
[Q = QUIT] Please enter your choice: █
```

1 = Interface Mode : 0=Auto IEEE1284
1=SPP IEEE1284 Nibble Mode
2=SPP IEEE1284 Byte Mode
3=ECP IEEE1284
Beispiel: 1=0

2 = Bidirectional Y/N/A : Enabling bidirectional mode
Example: 2=Y

3 = Print Page Y/N/A : Y=Testpage will be printed on every device start
N=Testpage will be never printed
A=Testpage will be printed if not network cable is connected after device start.
Example: 3=A

4 = Emulation : This is the same Option like in Serial Config Menü

5 = EmuCode : Customized function Code's

6 = BUS : Bus type see Page 38
Micro-C-SXL allowed only LPT here

7 = Keep Alive : Customized setting for Keep-Alive message
Example: 7=10 (10s)

8 = Recource Name : Unused in standard products

a = Local Port : Here you can define the TCP or UDP port approved for this interface

b = With SSL Y/N: Enable encrypted SSL communication

Below these points you can read the condition of the printer, as well as the properties of the individual lines.

Configuration with TELNET

Ethernet MENU

E, ETHERNET MENU



```
Telnet 192.168.100.100
----- ETHERNET MENU -----
1 = MAC - Address      = 08-BB-CC-04-11-11
2 = Ethernet Speed    = AUTO

For example: '2=AUTO'
-----
[Q = QUIT] Please enter your choice:
```

1 = MAC - Address **08-BB-CC-04-11-11**

This is the MAC address of the AK-XXL product which is used in the network. It cannot be changed:

2 = Ethernet Speed **AUTO**

Here you can determine which Ethernet speed will be used by your interface

The following entries are possible:
e=10HALF → 10Mbit Half/duplex
e=10FULL → 10Mbit Full/duplex
e=100HALF → 100Mbit Half/duplex
e=100FULL → 100Mbit Full/duplex
e=**AUTO** → AUTO sensing

Configuration WLAN

WLAN MENU

Configuration of the WLAN connection:

Generally there are three options to configure your ComPoint-WLAN-XXR.

1.) WPS(PBC)

The ComPoint-WLAN-XXR is delivered without any connection settings. If your access point supports the so-called push button method (WPS-PBC) we recommend you to use this method. Plug the power supply in the ComPoint-WLAN-XXR and wait until the "State LED" starts flashing rapidly. Then start the WPS-PBC function also **on** or **in** the access point and wait until the "State LED" flashes normally. This process can take up to 2 minutes. If no connection is established please repeat the process.

2.) Network (LAN)

Connect the ComPoint-WLAN-XXR to your local network and configure the ComPoint-WLAN-XXR with the browser or Telnet. To do so, follow the descriptions on the following pages.

You can edit the "WLAN.CFG" file as described under item 3.). Establish an FTP connection to the ComPoint-WLAN-XXR and edit the file "WLAN.CFG" which is located in "Volume 1".

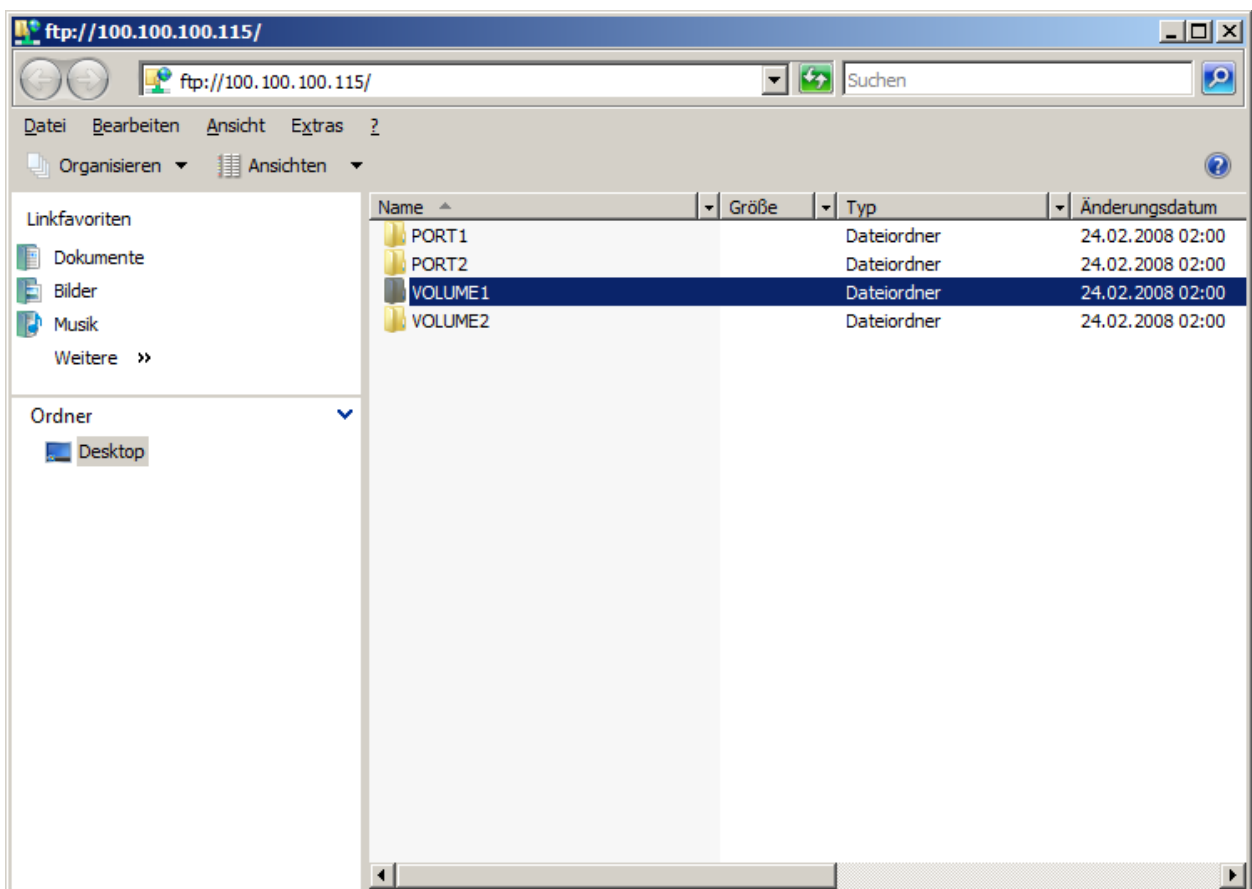

Configuration WLAN

Configuration of the WLAN connection:

3.) WLAN.CFG file

Connect the mini USB connection on the front side of the ComPoint-WLAN-XXR using the USB connection on your PC. Plug-in the power supply and wait until a new data drive (flash drive) is displayed in your PC.

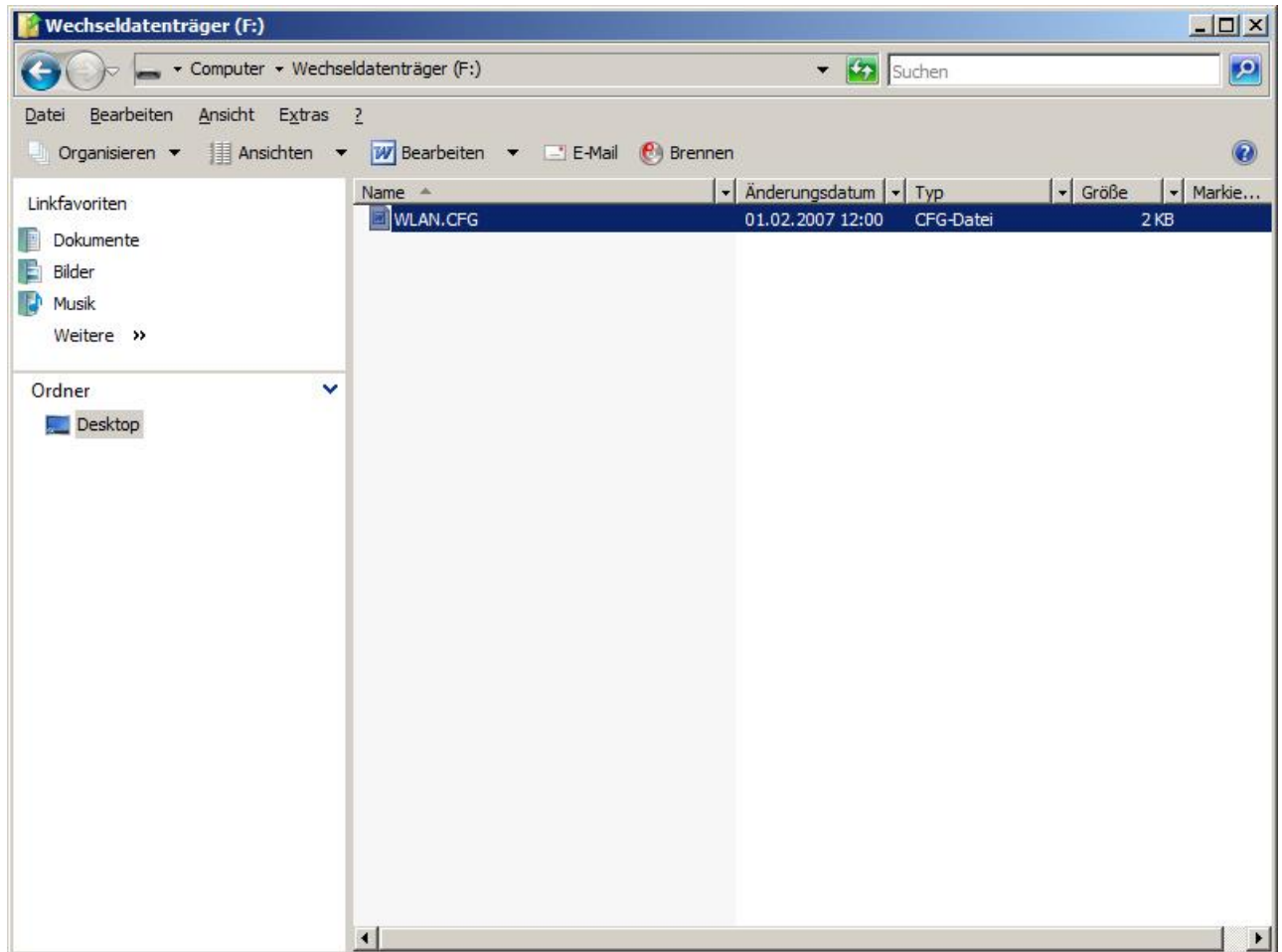

You will find the file “WLAN.CFG” on this data drive. You can edit it using the text editor and enter the following values:

```
SSID=WLAN
NetworkType=Infra
WirelessMode=5
AuthMode=WPAPSK
EncrypType=TKIP
WPAPSK=.....
```

Follow the explanations in the file “WLAN.CFG”. After completion please save this file again on the data drive and restart the ComPoint-WLAN-XXR.

Configuration with TELNET

Configuration of the AK-XXL products

W, WLAN MENU

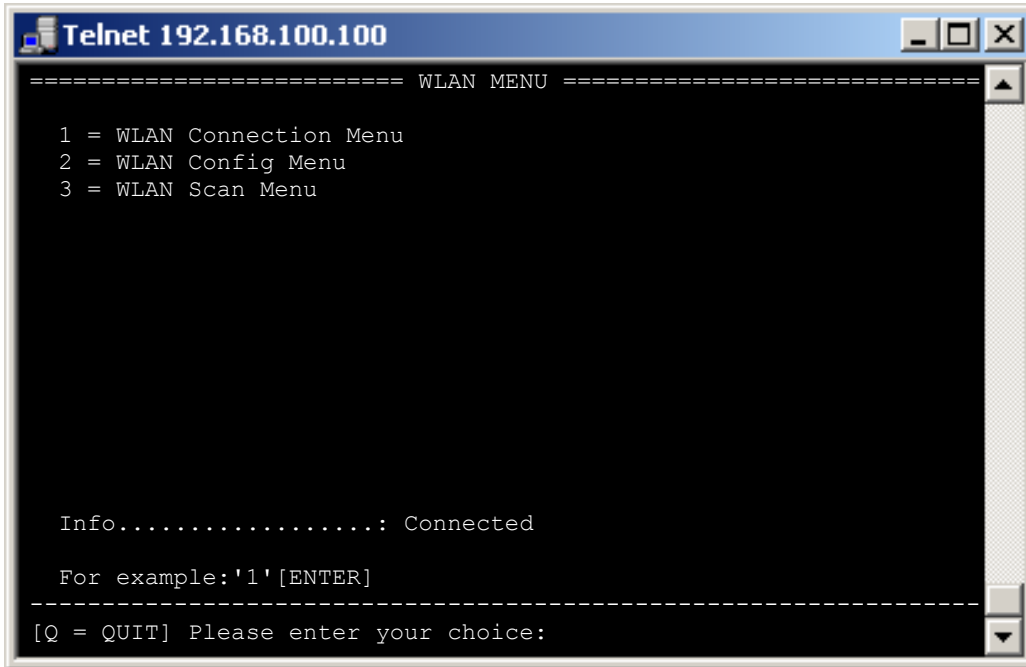

```
Telnet 192.168.100.100
===== WLAN MENU =====
1 = WLAN Connection Menu
2 = WLAN Config Menu
3 = WLAN Scan Menu

Info.....: Connected

For example: '1'[ENTER]
-----
[Q = QUIT] Please enter your choice:
```

1 = WLAN Connection Menu

Setting all connection data

2 = WLAN Config Menu

Setting additional functions

3 = WLAN Scan Menu

Searching and display all available access points

Configuration with TELNET

Configuration of the AK-XXL products

1 = WLAN Connection Menu

```
Telnet 192.168.100.100
===== WLAN CONNECTION MENU =====
1 = NetworkType      = INFRA (INFRA,ADHOC)
2 = SSID              = WLAN
3 = Wireless mode    = 6 (802.11n 2.4GHz)
4 = Authentication    = WPA1 (WPA1,WPA2,WPA1WPA2,WEP,OPEN)
5 = Encryption        = TKIP (TKIP,AES,TKIPAES)
6 = WPA-KEY           = *****

C = Connect
  Try to connect with the upper settings.
W = WPS (PBC)
  If your access point supports WPS then start the WPS-PBC
  mode at your access point first. Then press 'W' and wait
  several minutes.

Info.....: Connected (Quality 76%)

For example:'l=INFRA'
-----
[Q = QUIT] Please enter your choice:
```

- 1 = Network Type = **INFRA** Integrating in an infrastructure network (**via** access point)
ADHOC Direct connection (**without** access point)
- 2 = SSID = Name of the connection partner or of an access point
- 3 = Wireless mode = 0 = 802.11b/g legacy
1 = 802.11b legacy
2 = 802.11a legacy
3 = 802.11a/b/g legacy
4 = 802.11g legacy
5 = 802.11a/b/g/n mixed
6 = 802.11n 2.4GHz
7 = 802.11g/n mixed
8 = 802.11a/n mixed
9 = 802.11b/g/n mixed
10 = 802.11a/g/n mixed
- 4 = Authentication = **WPA1**, WPA2, WPA1WPA2, WEP, OPEN
- 5 = Encryption = **TKIP**, AES, TKIPAES
- 6 = WPA-KEY = Password

Configuration with TELNET

Configuration of the AK-XXL products

1 = WLAN Connection Menu

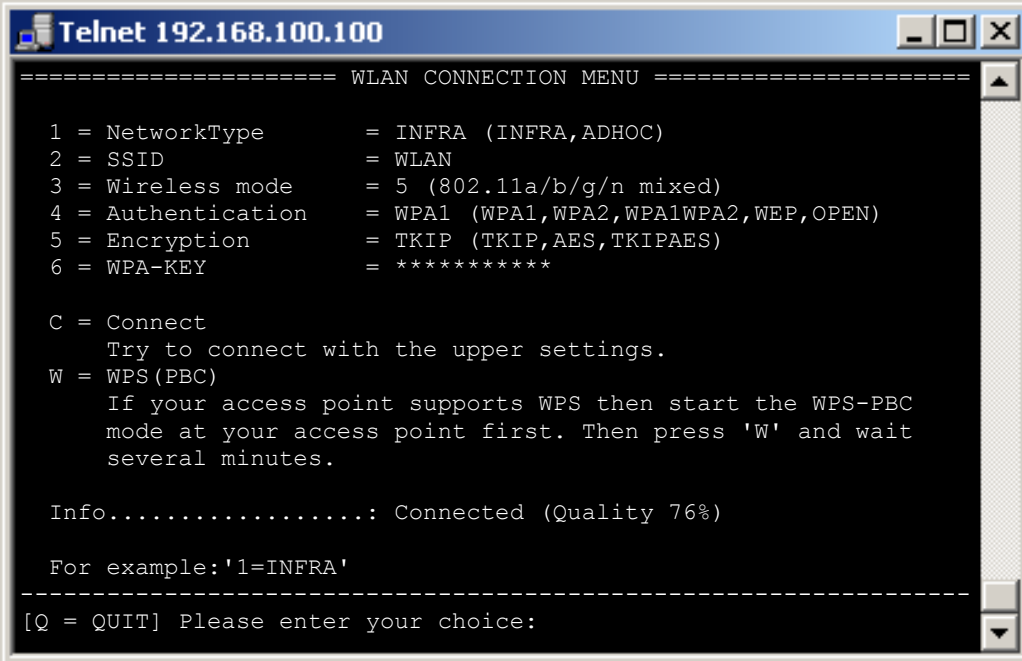

```
Telnet 192.168.100.100
===== WLAN CONNECTION MENU =====
1 = NetworkType      = INFRA (INFRA,ADHOC)
2 = SSID             = WLAN
3 = Wireless mode    = 5 (802.11a/b/g/n mixed)
4 = Authentication   = WPA1 (WPA1,WPA2,WPA1WPA2,WEP,OPEN)
5 = Encryption       = TKIP (TKIP,AES,TKIPAES)
6 = WPA-KEY          = *****

C = Connect
  Try to connect with the upper settings.
W = WPS (PBC)
  If your access point supports WPS then start the WPS-PBC
  mode at your access point first. Then press 'W' and wait
  several minutes.

Info.....: Connected (Quality 76%)

For example: '1=INFRA'
-----
[Q = QUIT] Please enter your choice:
```

C = Connect By entering **C + [ENTER]** you can try to establish a connection with the configuration settings (1-6) without restarting.

W = WPS(PBC) If your access point supports the so-called push button method WPS-PBC we recommend you to use this method. To do so, start this function on or in the access point and enter **W + [ENTER]**. The "State LED" will flash rapidly for about 2 minutes.

Info Shows you the current status. By entering **[ENTER]** this indication is updated.



Note:

When entering the option "C" and "W" the ComPoint-XXR requires sometime until it reestablishes the display. If you are using this function via the Wireless LAN connection the current connection will be completely interrupted.

Configuration with TELNET

Configuration of the AK-XXL products

2 = WLAN Config Menu

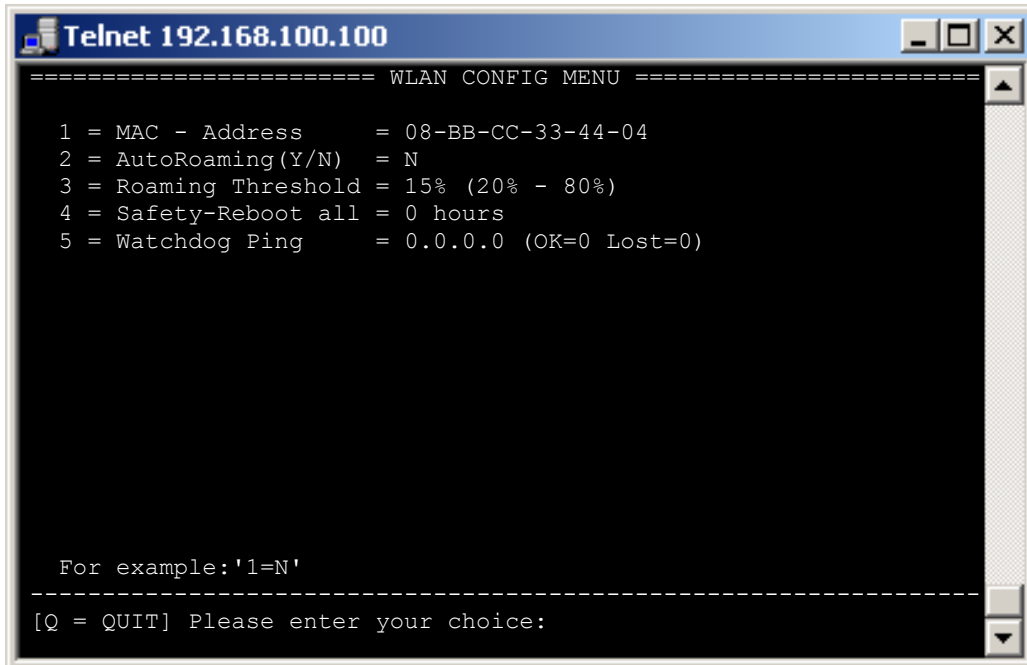

```
Telnet 192.168.100.100
===== WLAN CONFIG MENU =====
1 = MAC - Address      = 08-BB-CC-33-44-04
2 = AutoRoaming(Y/N)  = N
3 = Roaming Threshold = 15% (20% - 80%)
4 = Safety-Reboot all = 0 hours
5 = Watchdog Ping     = 0.0.0.0 (OK=0 Lost=0)

For example: '1=N'
-----
[Q = QUIT] Please enter your choice:
```

- | | |
|-----------------------|--|
| 1 = MAC - Address | This is the MAC address which is used by the <i>ComPoint-XXR</i> in the network. It cannot be changed: |
| 2 = AutoRoaming(Y/N) | If you have several access points with the same SSID you can reach them via this function in order that the ComPoint – XXR selects the access point having the best connection quality, |
| 3 = Roaming Threshold | Set the threshold value for the Auto-Roaming, i.e. from which connection quality on the ComPoint-XXR changes the access point. |
| 4 = Safety-Reboot all | Here you can indicate the time in hours when the interface should perform a restart and login at the access point again. |
| 5 = Watchdog Ping | Using this function it is possible to monitor the Wireless LAN connection. Every 30 seconds a ping is sent to the indicated IP address or the DNS name. If 4 pings are sent one following the other the WLAN will try to re-establish the connection. However , this only works if at least once a ping had been responded. You have to enter the IP address of your access point here. |

Configuration with TELNET

Configuration of the AK-XXL products

3 = WLAN Scan Menu

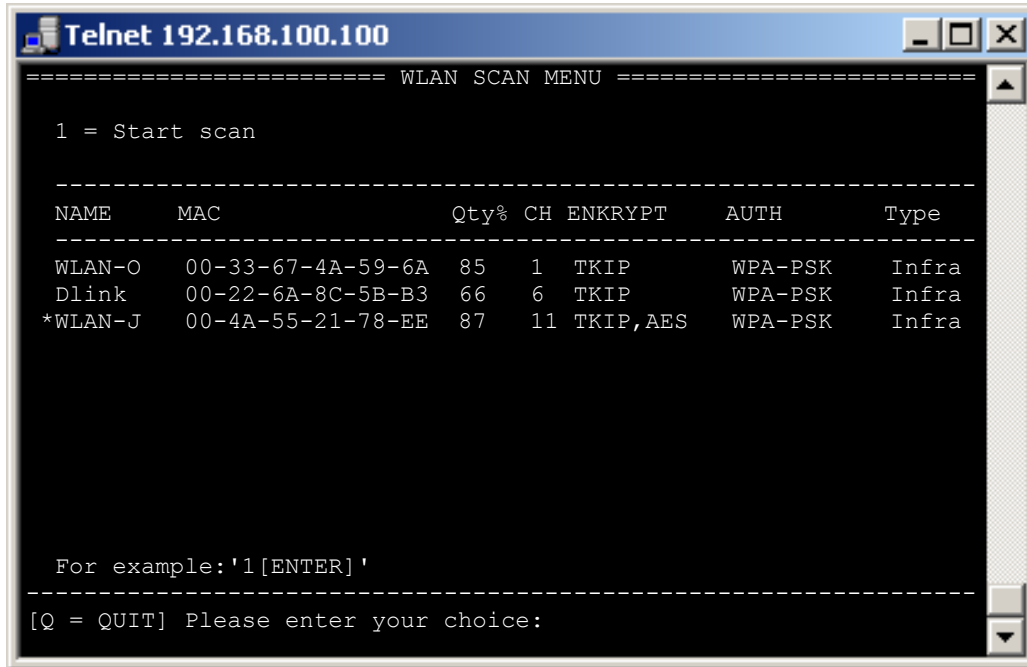

```
Telnet 192.168.100.100
===== WLAN SCAN MENU =====
1 = Start scan

-----
NAME      MAC                Qty% CH ENKRYPT  AUTH      Type
-----
WLAN-O    00-33-67-4A-59-6A  85   1  TKIP     WPA-PSK   Infra
Dlink     00-22-6A-8C-5B-B3  66   6  TKIP     WPA-PSK   Infra
*WLAN-J   00-4A-55-21-78-EE  87  11  TKIP,AES WPA-PSK   Infra

For example: '1[ENTER]'
-----
[Q = QUIT] Please enter your choice:
```

1 = Start scan

By entering **1 + [ENTER]** you can restart a search. You will obtain a list of all access points which are located within reach.

This list shows you the names (**SSID**), the Mac address (**MAC**), the reception quality (**Qty%**), the channel (**CH**), the encryption type (**ENKRYPT**), the authentication mode (**AUTH**) as well as the connection mode (**Type**).

Configuration with the browser

Configuring AK-XXL products with the browser

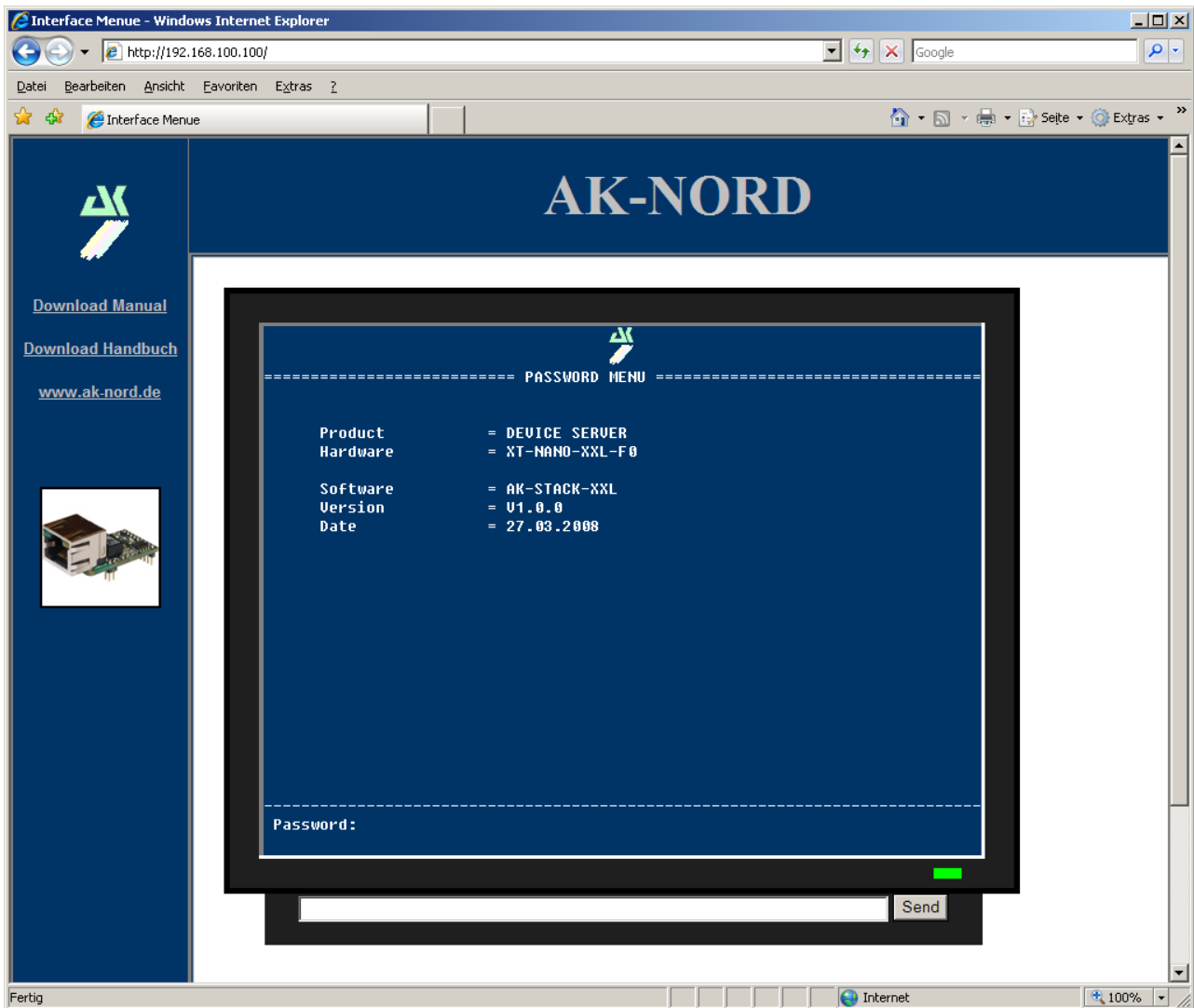

All entries are performed in the same way as for the configuration by Telnet.



Important:

All written data are saved as soon as they are entered. However, it is necessary to make a R=Restart on the main level in order activate the values.

Configuration via the V24

Configuration via the V24 (only serial versions)



- 1.) AK-XXL product is switched on.
- 2.) AK-XXL product is connected to the PC via the V24 (e.g. COM1)
- 3.) COM / TERMINAL program, e.g. Hyperterminal is available.
- 4.) COM is set to 115200,8,n,1
(baud rate 115200, 8 data bits, no parity, 1 STOP bit)

EXAMPLE:

Check the settings of an AK-XXL product.

Start the program HyperTerminal. You can use each terminal program which has the option to open a COM interface on your PC. Open the COM port. Start the AK-XXL product and press the following keys in the console window within 2 seconds after having switched on the device:

Esc, Esc, TELNET

Now you have entered the Telnet program of the interface.

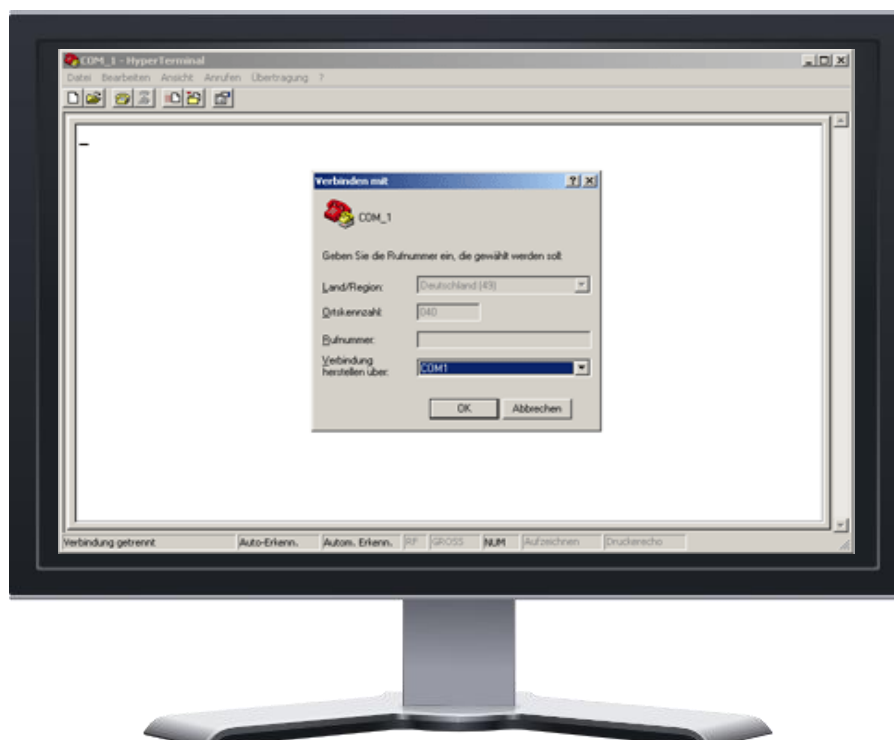

Configuration via the V24

Configuring AK-XXL products

If you have correctly entered the key combination of the AK-XXL product, the following menu is displayed on the screen:

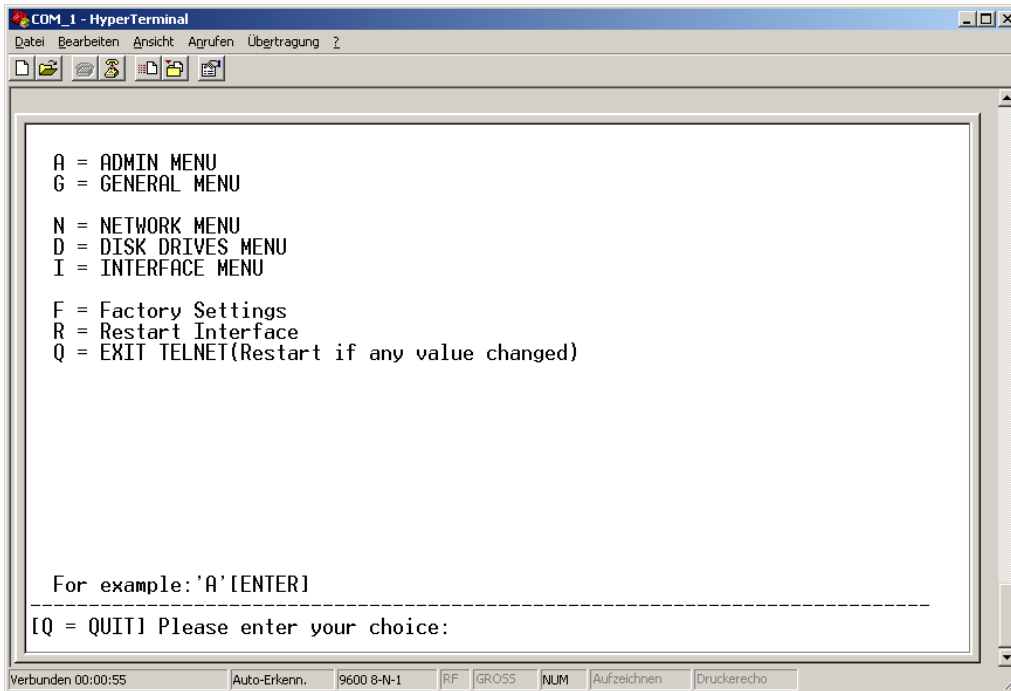

The screenshot shows a HyperTerminal window titled "COM_1 - HyperTerminal". The menu displayed is as follows:

```
A = ADMIN MENU
G = GENERAL MENU

N = NETWORK MENU
D = DISK DRIVES MENU
I = INTERFACE MENU

F = Factory Settings
R = Restart Interface
Q = EXIT TELNET(Restart if any value changed)
```

Below the menu, it says "For example: 'A' [ENTER]" and "-----". At the bottom of the terminal area, it says "[Q = QUIT] Please enter your choice:". The status bar at the bottom of the window shows "Verbunden 00:00:55" and several status indicators: "Auto-Erkenn.", "9600 8-N-1", "RF", "GROSS", "NUM", "Aufzeichnen", and "Druckerecho".



Note:

For configuration refer to "Telnet"

XT-Admin

Description of XT-Admin

Please find a description of our configuration and management tool XT-Admin on the following pages.

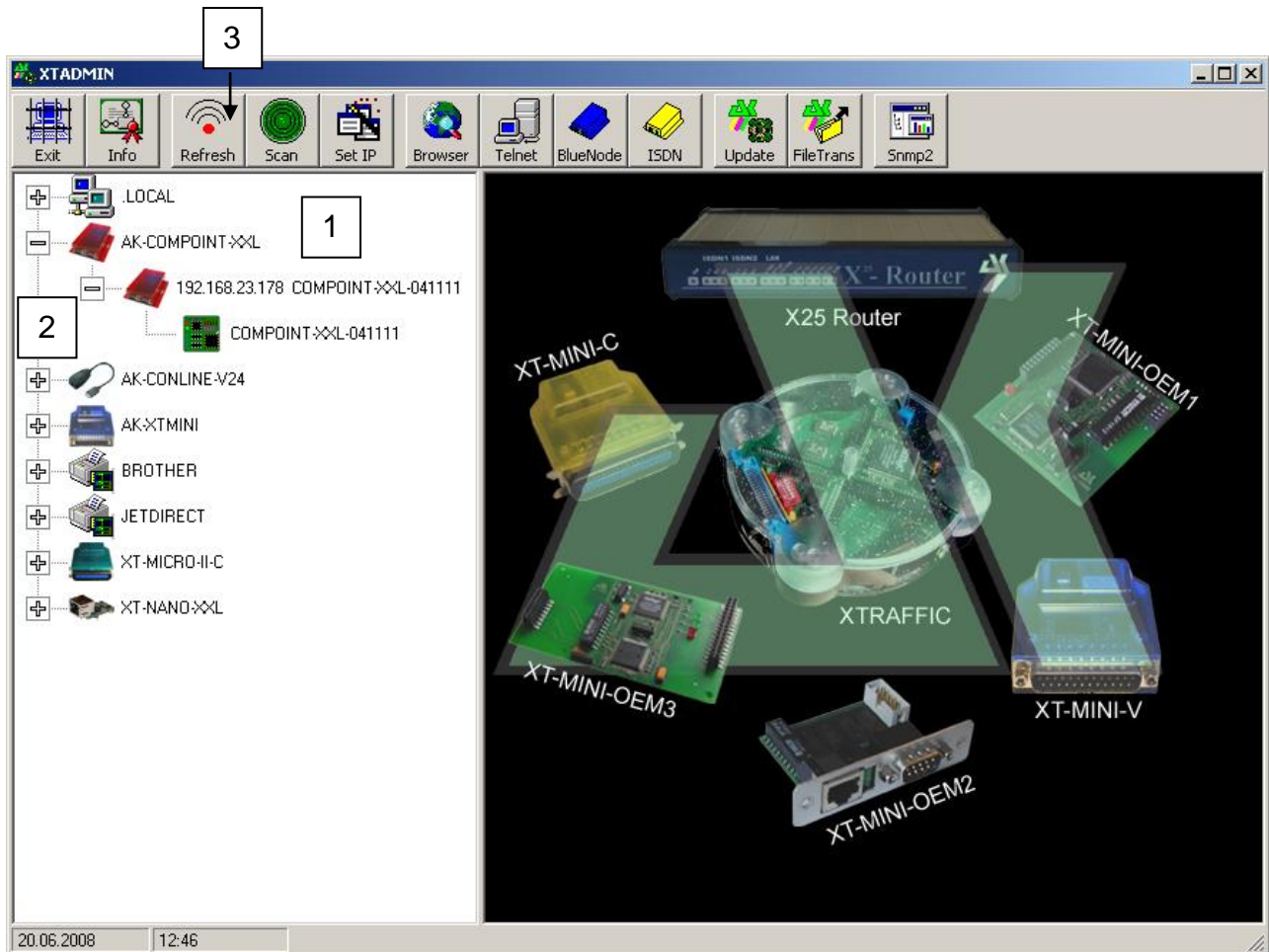

1. All interfaces which are included in the network are displayed in this option, no matter if the IP address is available or not.
2. By clicking on the cross, the interfaces are extended. If there is no cross, it is not possible to address the interfaces.
3. By pressing on the “Refresh“ button the list will be updated

XT-Admin

Description XT-Admin, Set IP

Using the Set IP function, you can assign a new IP to your interface by a push on a button, also if it is outside your subnet.

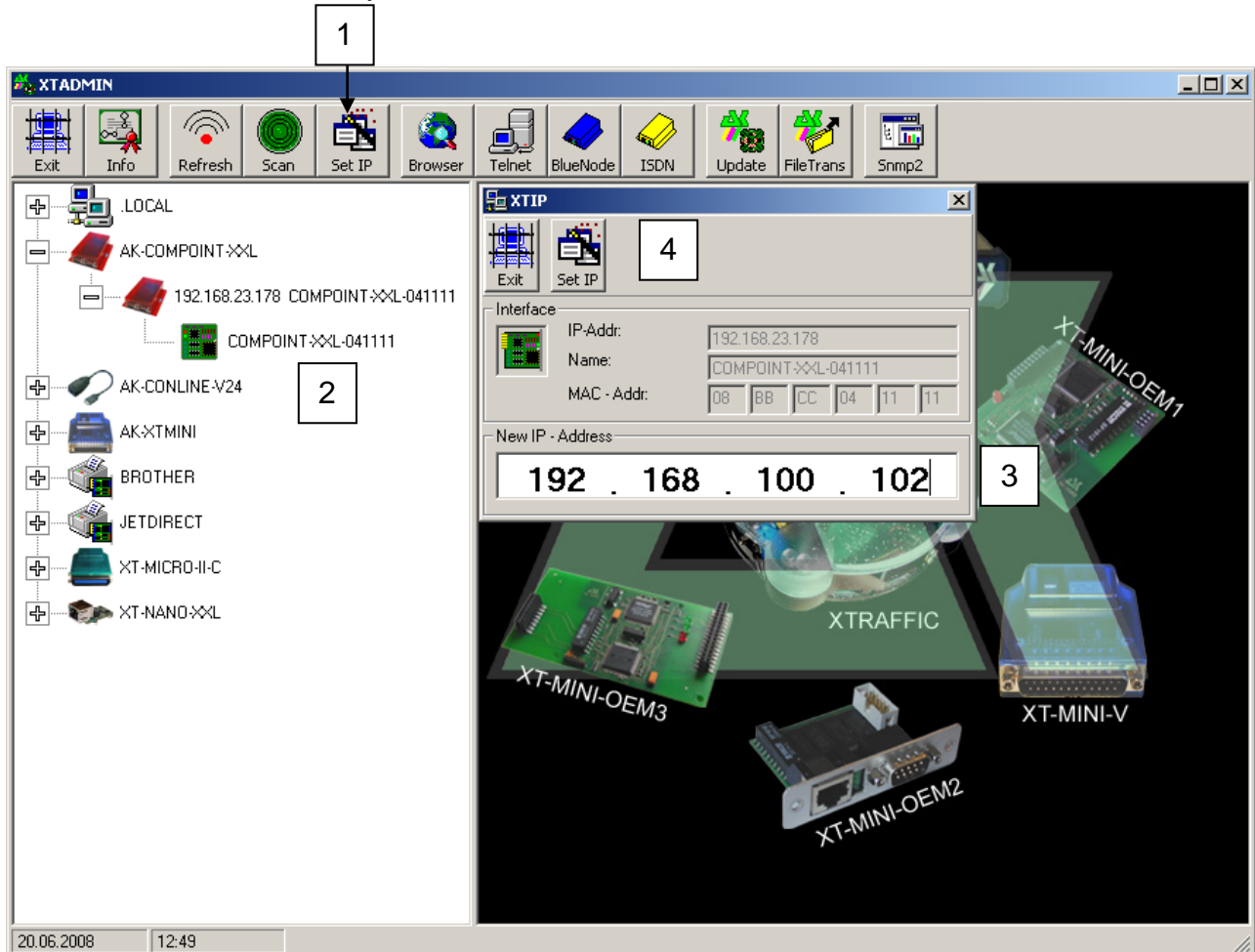

1. By clicking on “Set IP“ the window **XTIP** will open
2. Select the interface in the menu on the left to which you would like to assign a new IP address. The values of this interface will automatically be taken over to the window Set IP.
3. Enter a new IP address to this field.
4. In order to set this IP address, press the button “Set IP“. After a short time, the interface will be listed on the left with its new IP address.

XT-Admin

Description XT-Admin, Telnet

Using the Telnet function you can establish a Telnet connection to your interface.

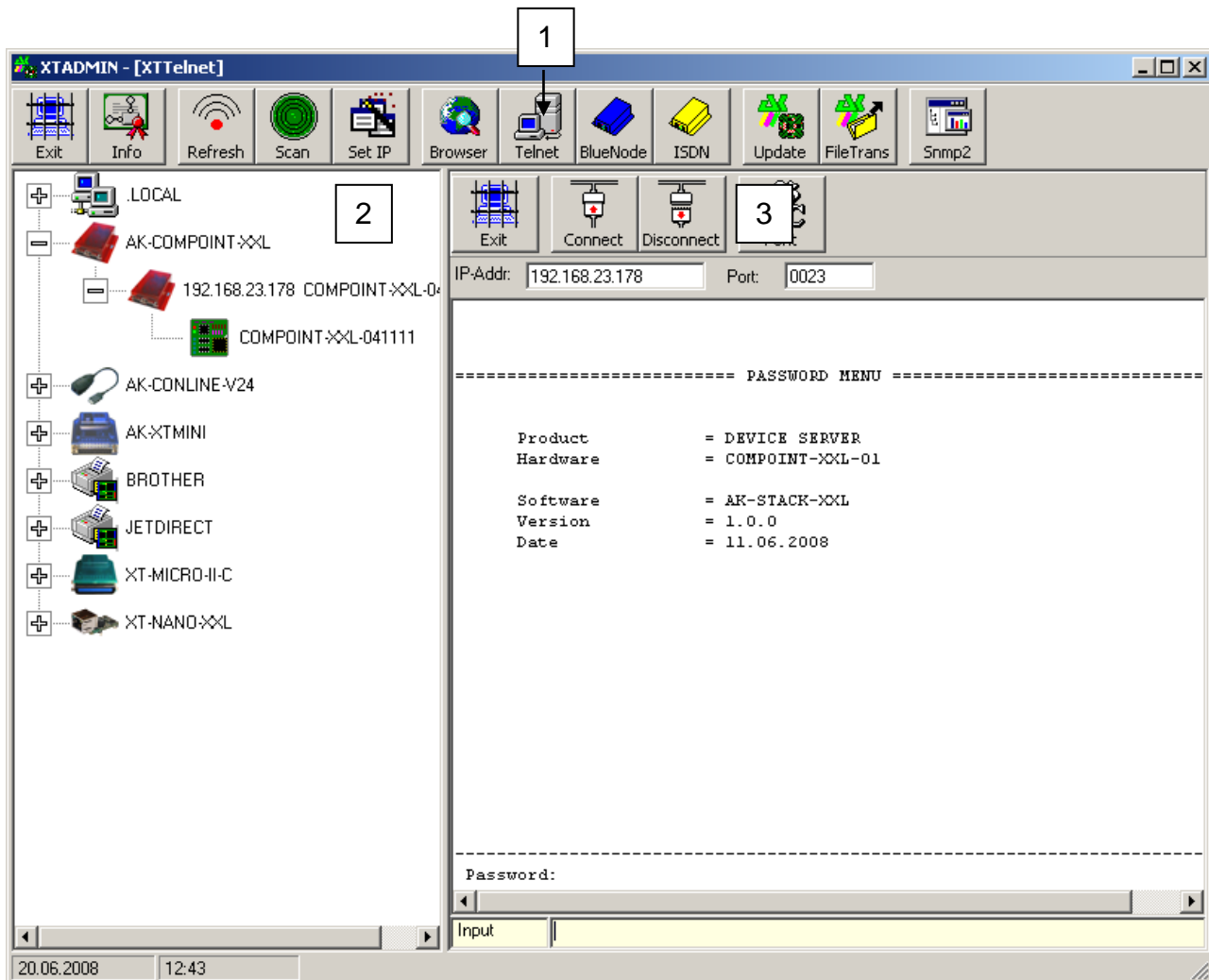

1. By clicking on “Telnet“ the window **XTTelnet** will open
2. Select the interface in the menu on the left which you would like to configure by Telnet. By clicking on this interface, the IP address will be taken over to the Telnet address field.
3. Click on “Connect“ in order to establish a connection. Click on “Disconnect“ to terminate the connection. Please find further information regarding configuration via Telnet in chapter Telnet.

XT-Admin

Description XT-Admin, Update

Using the Update function you can update the firmware of your AK-XXL product via the network.

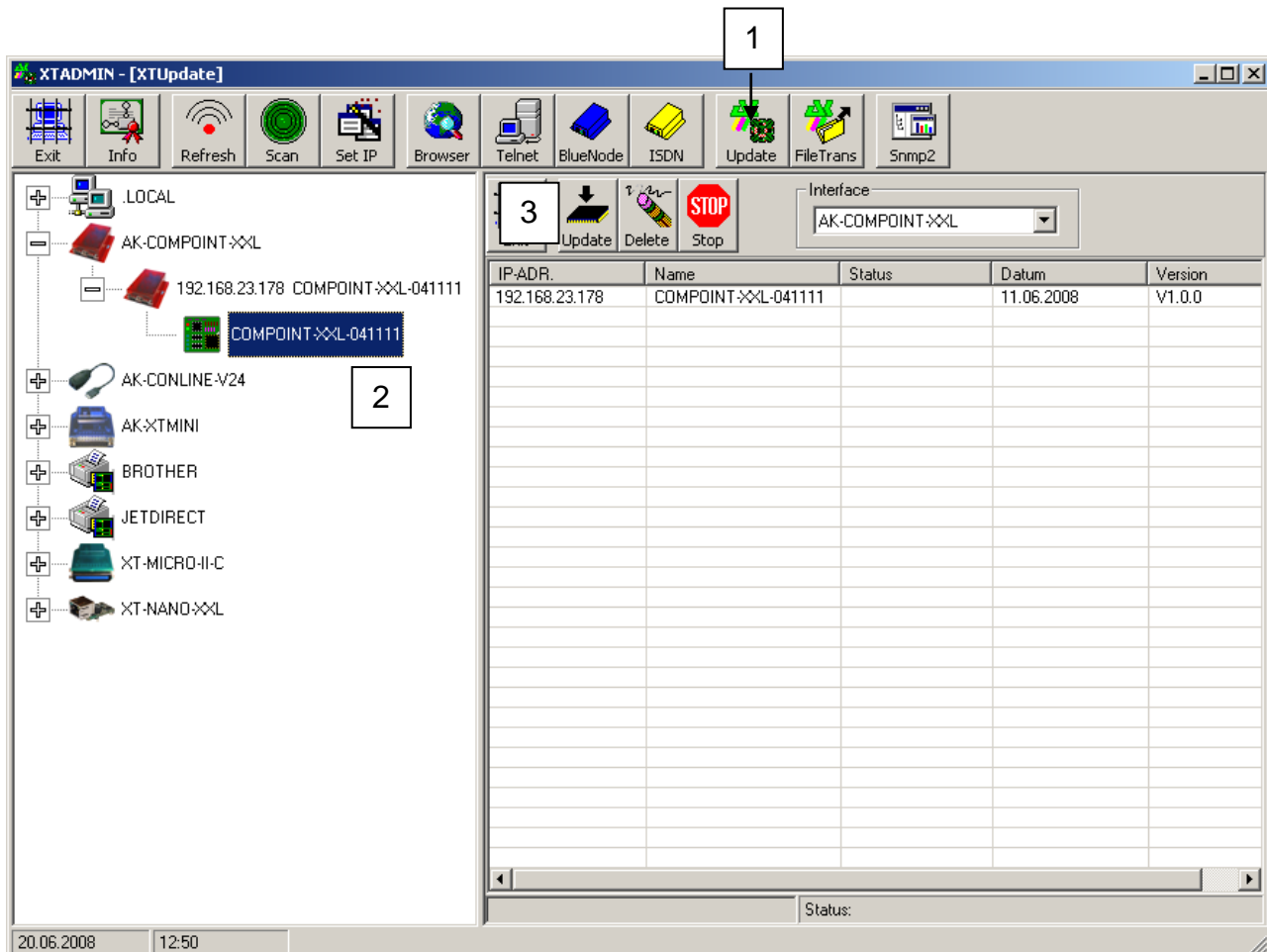

1. By clicking on “Update” the window **XTUpdate** will open
2. Click on the interfaces which you would like to update. It is possible to enter several interfaces and to automatically provide them with a new software version one after another.
3. When you have entered all interfaces to the list, click on the button Update and select the software version file.

File transfer (FTP)

Description XT-Admin-XXL, File transfer(FTP)

In order to copy data to the internal FlashDrive or external FlashDrive (SD card) you can use a standard FTP program, Windows Explorer or our XT-ADMIN-XXL. This function is required if you want to use an own homepage or SSL certificates. In our example we use XT-ADMIN-XXL.

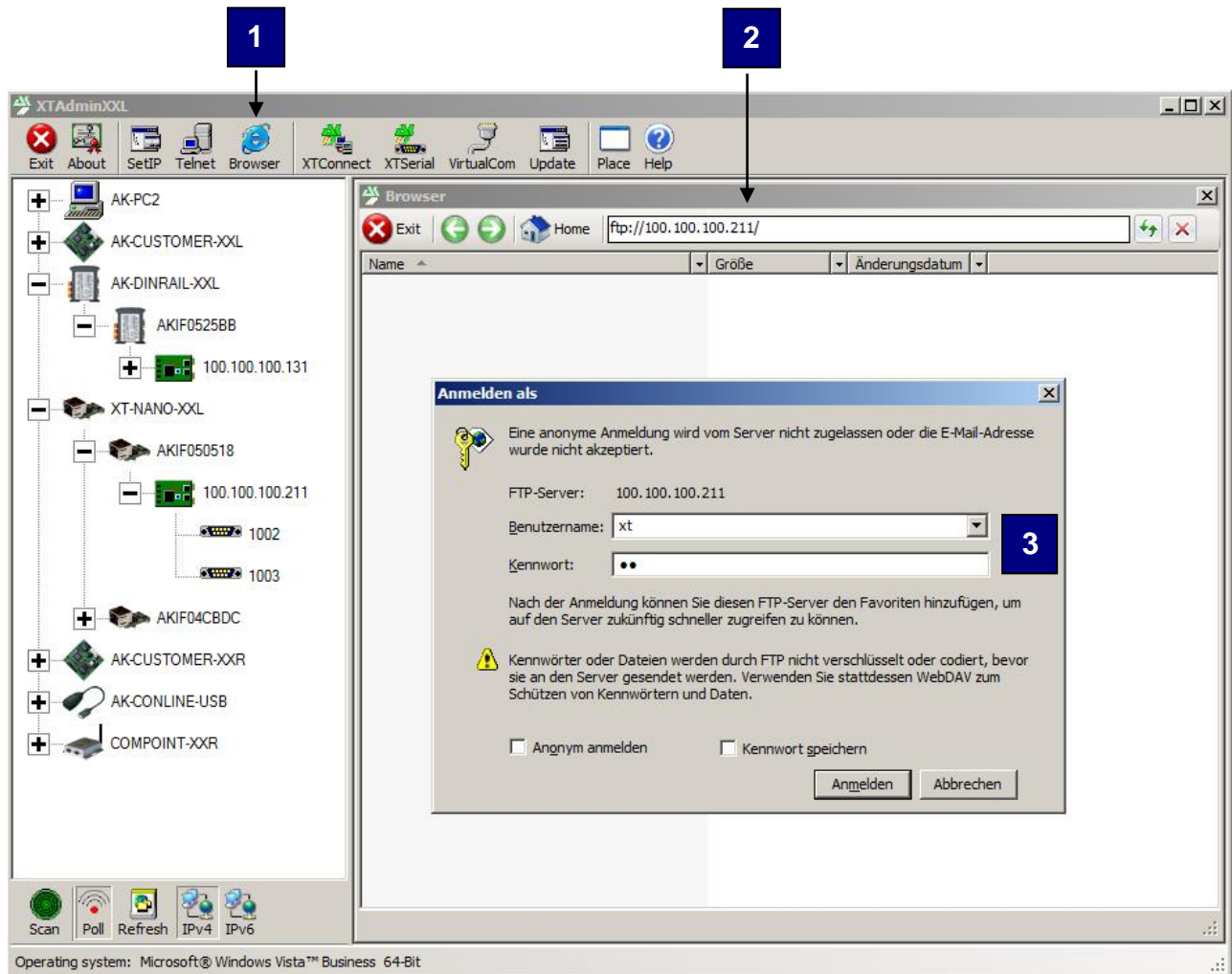

4. By clicking on “**Browser**” the Browser window opens up.
5. Select an interface, change the transferring address such as e.g. <http://100.100.100.211> to <ftp://100.100.100.211> and then press **ENTER**.
6. Then you are requested to enter the password and the user name. The standard password as well as the standard user name are “**XT**”.

File transfer (FTP)

Then a data window is displayed where you can exchange files using the common **Drag&Drop** function.

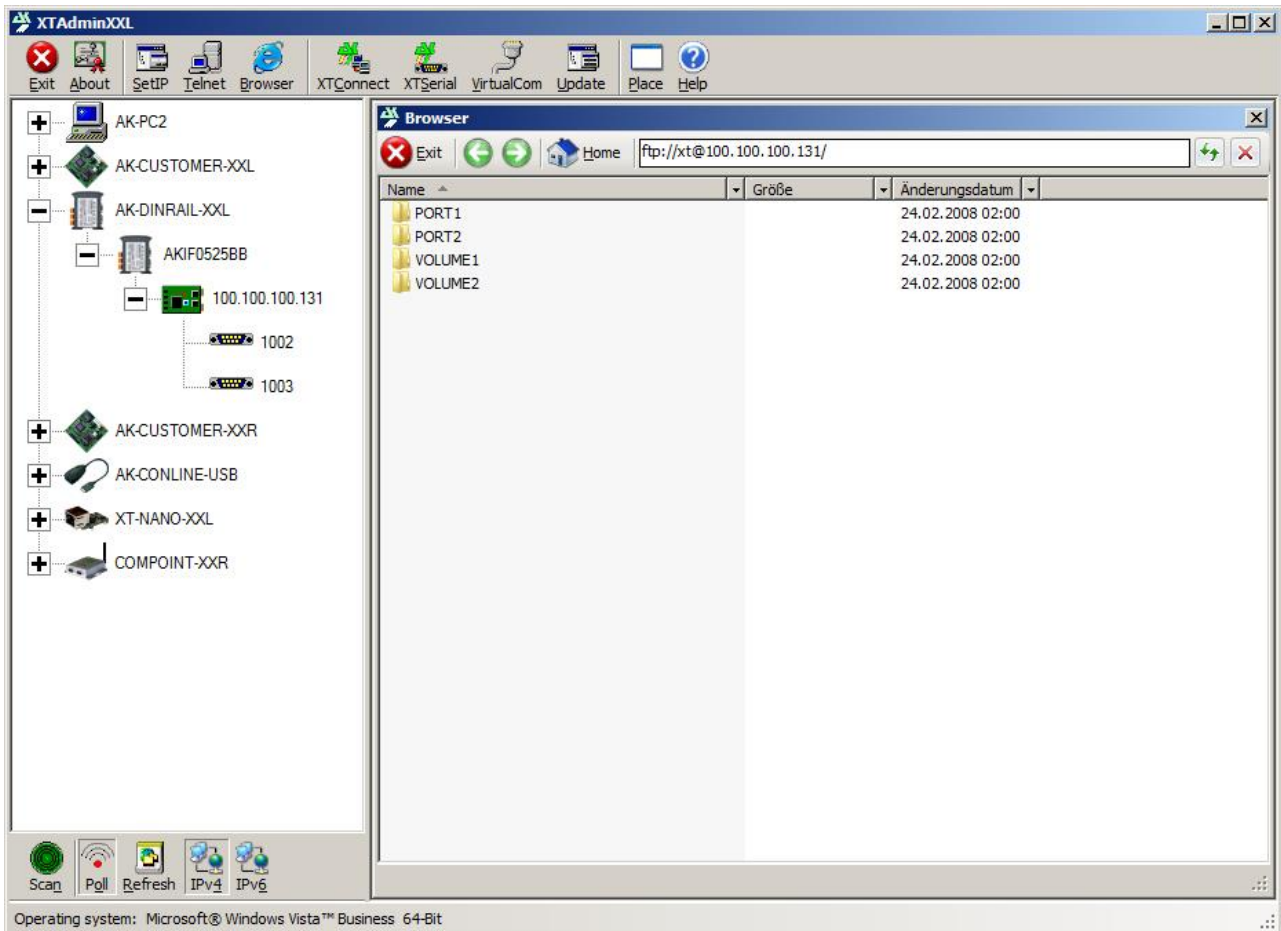

PORTx:

By opening the folder PORT1 or PORT2 you have access to the interfaces of the AK-NORD device server. All files which you copy in this folder are directly transferred to the corresponding interfaces.

VOLUME1:

By opening the folder VOLUME1 you access the internal FlashDrive "A". Please check how much memory is available by clicking on the "DISK DRIVES MENU". Generally it amounts to 15KB. The SSL certificates are filed here. You can also file the "INDEX.HTM" for your homepage here and copy all other HTML files to the Volume2 (SD card).

VOLUME2:

If an SD card is inserted (if this option is available) you can save up to 4GB data here. If no SD card is available or if it is not formatted an error message will be displayed.

SSL / TLS

SSL settings



Note:

At the time of writing the SSL option was tested. Please ask AK-NORD whether this option is included in the latest or current version.

From **version 1.x.x on** and using the corresponding software you have the option to exchange encrypted SSL/TLS data with our interfaces. If SSL/TLS is available you will find the following menu in the “**NETWORK MENU**” under “**D = SSL MENU**”:

```
192.168.100.100 - PuTTY
===== SSL MENU =====
1 = Cert. password      =
2 = SSL-Syslog (Y/N)   = N
3 = Server verify opt.= 0 (None)
4 = Server Cert Number= 0 (1024 BIT)
5 = Server protocol    = 0 (AUTO)
6 = HTTPS protocol     = 0 (AUTO)
7 = Client verify opt.= 0 (None)
8 = Client protocol    = 0 (AUTO)
9 = Option              = 0000
For example:'2=0'
-----
[Q = QUIT] Please enter your choice: █
```

- 1 = Cert. password = If your certificates are protected by a password please enter the password here. Otherwise the interface cannot process the certificates.
- 2 = SSL-Syslog (Y/N) = This is a “Debug” function. If problems occur when establishing a connection you can set this parameter to “Y”. All individual steps of establishing a connection are logged and sent to a Syslog server. To do so you also need to activate the Syslog functions in the Admin menu.

SSL / TLS

3 = Server verify opt.= Possible values = 0,1,2,4
0 = None (SSL_VERIFY_NONE)
1 = Peer (SSL_VERIFY_PEER)
2 = Fail if no peer cert (SSL_VERIFY_FAIL_IF_NO_PEER_CERT)
4 = Client once (SSL_VERIFY_CLIENT_ONCE)

Please find a detailed description on the following page!

Note:

It is also possible to link/add the values in order to activate several functions at a time. For instance:
7 = (Peer,Fail if no peer cert,Client once)

4 = Server Cert Number= Possible values = 0,1
0 = 1024 Bit
1 = 2048 Bit

5 = Server protocol = Possible values = 0,1,2,3,4
(For all server application)
0 = Auto
1 = SSLv3
2 = TLS1.0
3 = TLS1.1
4 = TLS1.2

6 = HTTPS protocol = Possible values = 0,1,2,3,4
(Only for Webserver application)
0 = Auto
1 = SSLv3
2 = TLS1
3 = TLS1.1
4 = TLS1.2

7 = Client verify opt. Possible values = 0,1
0 = None (SSL_VERIFY_NONE)
1 = Peer (SSL_VERIFY_PEER)

Please find a detailed description on the following page!

8 = Client protocol = Possible values = 0,1,2,3,4
(For all client application)
0 = Auto
1 = SSLv3
2 = TLS1.0
3 = TLS1.1
4 = TLS1.2

9 = Option = 0001 Checking the date fields in certificates is activated

SSL / TLS

SSL - Verify - Options

SSL_VERIFY_NONE

Server mode: the server will not send a client certificate request to the client, so the client will not send a certificate.

Client mode: the server will send a certificate which will be checked and used for the communication.

SSL_VERIFY_PEER

Server mode: the server sends a client certificate request to the client. The certificate returned (if any) is checked. If the verification process fails, the TLS/SSL handshake is immediately terminated with an alert message containing the reason for the verification failure. The behaviour can be controlled by the additional `SSL_VERIFY_FAIL_IF_NO_PEER_CERT` and `SSL_VERIFY_CLIENT_ONCE` flags.

Client mode: the server certificate is verified. If the verification process fails, the TLS/SSL handshake is immediately terminated with an alert message containing the reason for the verification failure. If no server certificate is sent, because an anonymous cipher is used, `SSL_VERIFY_PEER` is ignored.

SSL_VERIFY_FAIL_IF_NO_PEER_CERT

Server mode: if the client did not return a certificate, the TLS/SSL handshake is immediately terminated with a "handshake failure" alert. This flag must be used together with `SSL_VERIFY_PEER`.

Client mode: ignored

SSL_VERIFY_CLIENT_ONCE

Server mode: only request a client certificate on the initial TLS/SSL handshake. Do not ask for a client certificate again in case of a renegotiation. This flag must be used together with `SSL_VERIFY_PEER`.

Client mode: ignored

SSL / TLS

Other SSL settings

Please find the parameter of the corresponding interface (RS232,RS485,TTLIO etc.) in the “Config Menu” of all interfaces

f = With SSL/TLS = Possible values = N,Y

Y= The data are transferred only encrypted.

N = The data are transferred non encrypted.

HTTP / HTTPS. The setting “**BROWSER**” in the **ADMIN-MENU** was enhanced. If SSL/TLS is available you can decide if the configuration shall work only encrypted or encrypted and non encrypted via the Browser.

4 = Browser (Y/N/M) = Possible values = N,Y,M

N= Webserver switched off.

Y= Webserver can be accessed via the HTTP Port 80(non-encrypted) as well as HTTPS Port 443 (encrypted).

M = The access via HTTP Port 80 (non-encrypted) is automatically redirected to HTTPS Port 443 (encrypted).

SSL / TLS

SSL/TLS in the server mode

Encryption and certificate control:

When using SSL/TLS without other or special certificates the internal certificates of the AK-NORD interface are always used for a connection via HTTPS or a secured TCP/IP connection. In this way it is guaranteed that the data exchange is encrypted in any case and that it is not possible to read the content in the network. However, the Browser will always indicate an unsafe connection.

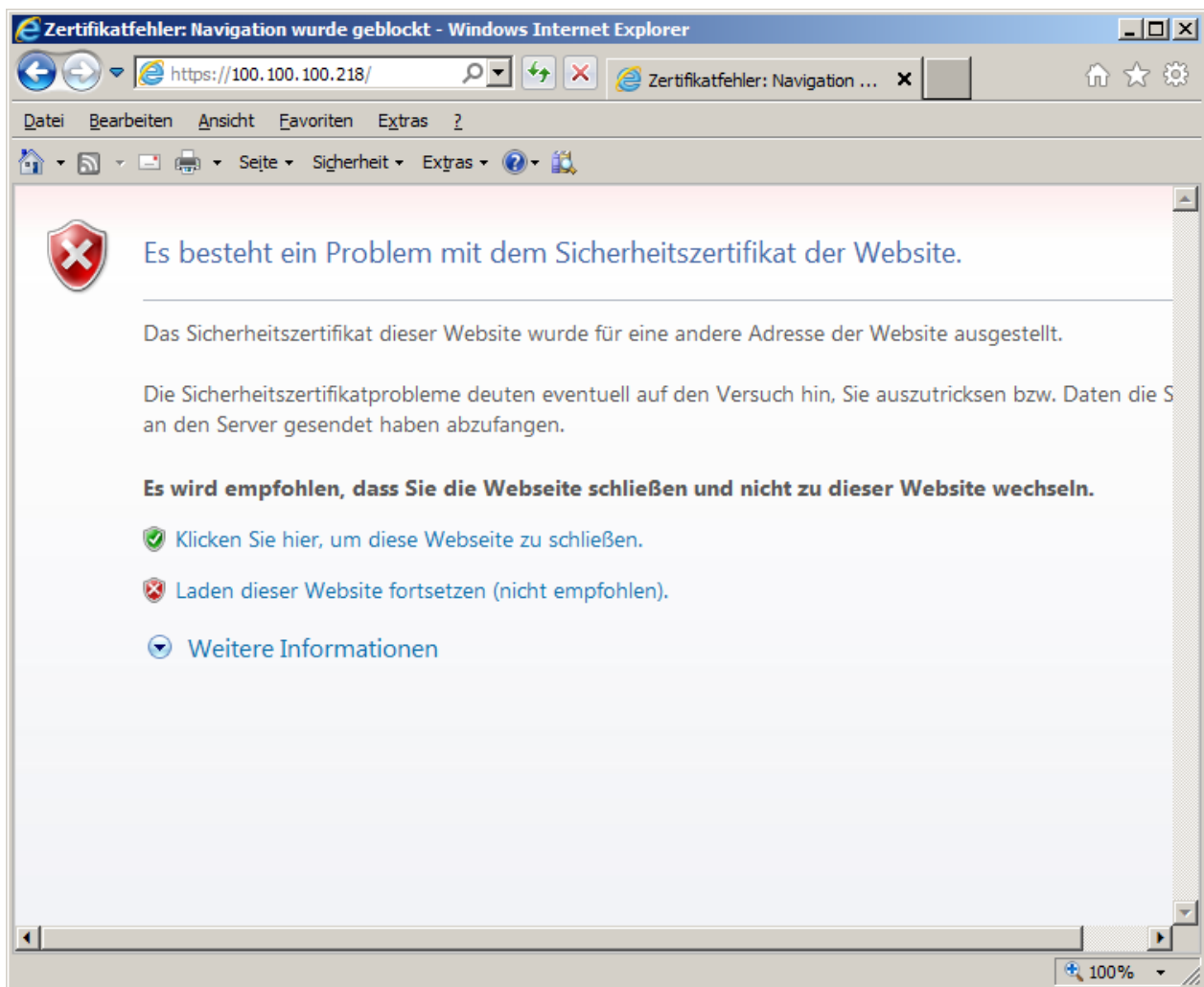

This is due to the reason that the browser (Client) obtains a certificate of the AK-NORD interface (Server) when establishing the connection which he cannot check or which was signed by a certification body (CA) which is not known to the browser. It is also possible that the certificate was created for another name (CN) which does not correspond to the above indicated address (IP).

SSL / TLS

Server certificate (Server side certificate)

In order that the Browser (Client) establishes a connection to the AK-NORD interface (Server) and is able to determine without doubts that he is really connected to the AK-NORD interface it is necessary to install a certificate on the AK-NORD interface (Server). To do so have a certificate created by a “CA” for the DNS name of the AK-NORD interface e.g. “AKIF04504B” and install it on the AK-NORD interface (Server). To do so, please proceed in the same way as for “File transfer (FTP)” and copy the certificate on the root directory of the AK-NORD interface.

The certificate must have the following properties.

- 1.) The suffix of the certificate must always be “xxxxxxx.CRT”.
- 2.) The suffix of the key must always be “xxxxxxx.KEY”.
- 3.) The file name must correspond to the DNS name or be “AK_SERVER”.
The letters can be upper or lower case.
- 4.) Both files have to be saved in the “PEM” format.

Example:

The assigned DNS name of the AK-NORD interface is e.g. “AKIF04504B”. Then you can either copy

AKIF04504B.CRT
AKIF04504B.KEY

or generally

AK_SERVER.CRT
AK_SERVER.KEY

on the AK-NORD interface.

Note:

If the certificate is edited by an official “CA” it is not necessary to do anything else. If you create a certificate yourself e.g. using the OPENSSEL tool then you have to install the corresponding CA file using the public key in your Browser.

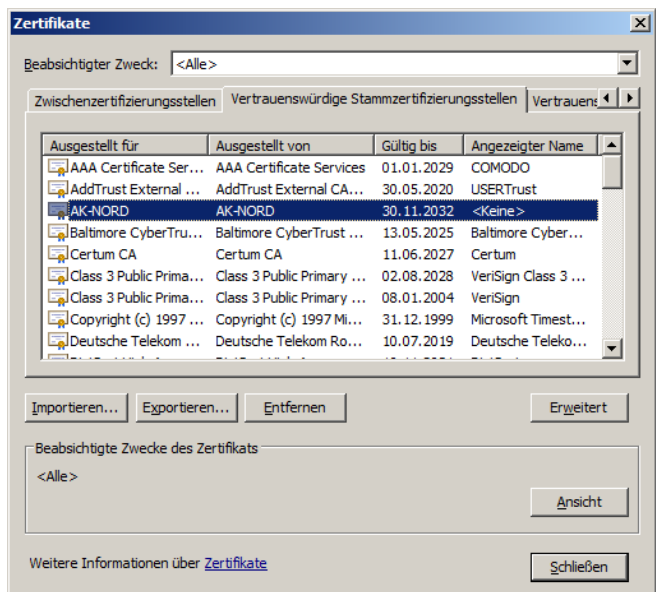

Restart your Browser and enter e.g. “HTTPS:// AKIF04504B”. Your Browser will no longer indicate an unsafe connection.

SSL / TLS

Client certificate (Client side certificate)

Client certificates do not distinguish themselves from the server certificates but they are used in another way. A server certificate serves a Browser for instance to verify the identity of an AK-NORD interface (Server) in the Internet or in the network. On the other hand a client certificate would allow the AK-NORD interface (Server) to check the identity of the user of the Browser. Thus there is the option to allow the access to the AK-NORD interface via the Browser via the encrypted TCP/IP connection only to admitted or selected users.

To do so it is possible to create a client certificate by the certification body (CA) and install it also in the corresponding browser.

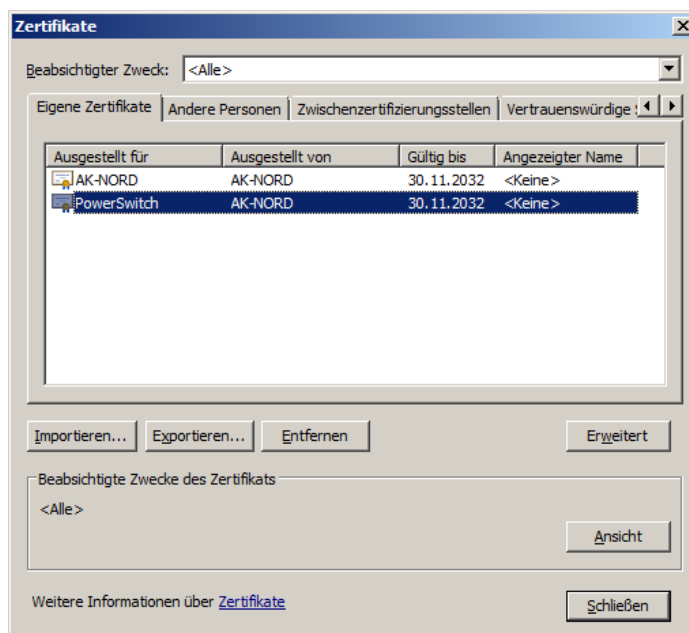

After that you have to copy the corresponding CA file including the public key to the AK-NORD interface (Server) and set the “Verify option” in the **SSL menu** to “7”.

The CA file must have the following properties.

- 1.) The name of the CA file must always be “AK_CA.CRT”
The letters can be upper or lower case.
- 2.) The file needs to be saved in the “PEM” format.

Note:

If you use both functions (Server mode as well as client mode) at the same time and different CA files for both connections then you must name the CA file for the server mode “AK_CA_S.CRT” and the CA file for the client mode “AK_CA_C.CRT” and file them in the AK-NORD interface.

SSL / TLS

Restart your Browser and enter e.g. “HTTPS:// AKIF04504B”. Then your Browser will request you to select a client certificate for the connection. If your Browser cannot prove this certificate or if you transfer the wrong certificate the connection will not be allowed.

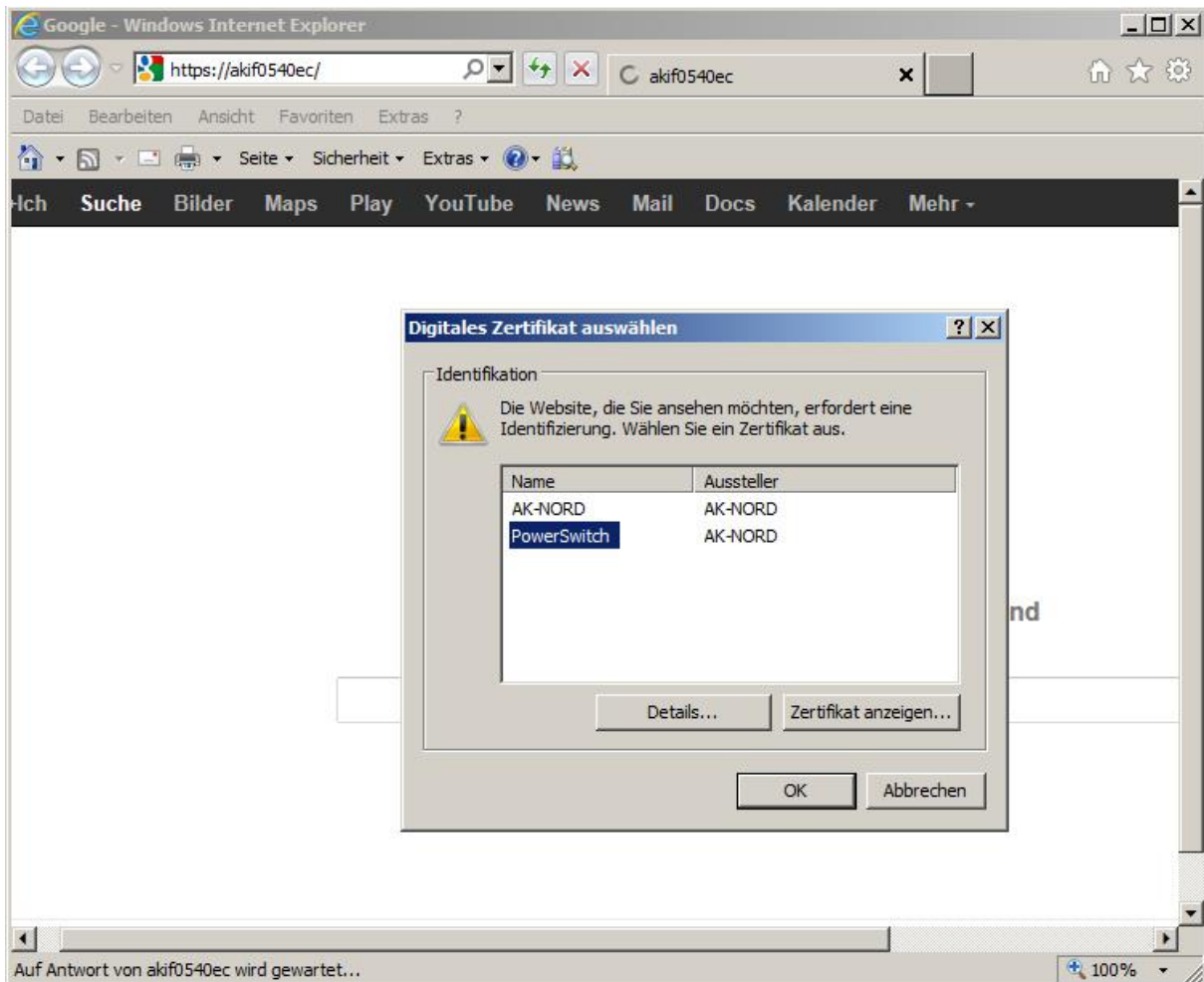

Note:

If you do not want to purchase an official certificate for your application we will help you in creating these certificates using the OPENSSL tool.

SSL / TLS

SSL/TLS in the client mode

Encryption and certificate control:

When using SSL/TLS without any other or special certificates the server certificates are always used for establishing a connection to a TCP server with SSL/TLS. In this way it is guaranteed that the data exchange is encrypted in any case and that it is not possible to read the content in the network.

Client certificate

When using the verify option of the TCP server or of the AK-NORD interface you have to create and file the certificates as follows:

1.) The TCP server wants to check the AK-Nord interface.

The client certificate must have the following properties:

- 1.) The suffix of the certificate must always be "xxxxxxx.CRT".
- 2.) The suffix of the key must always be "xxxxxxx.KEY".
- 3.) The file name must be "AK_CLIENT".
The letters can be upper or lower case.
- 4.) Both files have to be saved in the "PEM" format.

2.) The AK-Nord interface wants to check the TCP server.

The CA file must have the following properties.

- 1.) The name of the CA file must always be "AK_CA.CRT"
The letters can be upper or lower case.
- 2.) The file needs to be saved in the "PEM" format.

Note:

If you use both functions (Server mode as well as client mode) at the same time and different CA files for both connections then you must name the CA file for the server mode "AK_CA_S.CRT" and the CA file for the client mode "AK_CA_C.CRT" and file them in the AK-NORD interface.

Examples of applications

ConnectOnData

Short description:

The emulation ConnectOnData will be used to establish a connection to a predefined target if required, i.e. as soon as the interface is receiving data from a terminal. All connection data are stored in the interface. In doing so, the connection is bidirectional and transparent. As long as the connection is established, it is possible to send data from the interface to the PC, as well as from the PC to the interface. This connection remains established until the Port-Timeout (NETWORK – Menu → TCP menu) has expired after sending or receiving the last character.

Example:

An alarm system shall be able to send an alarm message to a PC by TCP/IP, if necessary. As soon as the alarm system has sent a message to the device server ComPoint-LAN-XXL via the serial interface, it establishes a connection to the server 192.168.10.1 and transfers all data directly to port 3000. If this server is not available, it is possible to establish an alternative connection to the server 192.168.10.2 due to the redundancy ability of the device server.

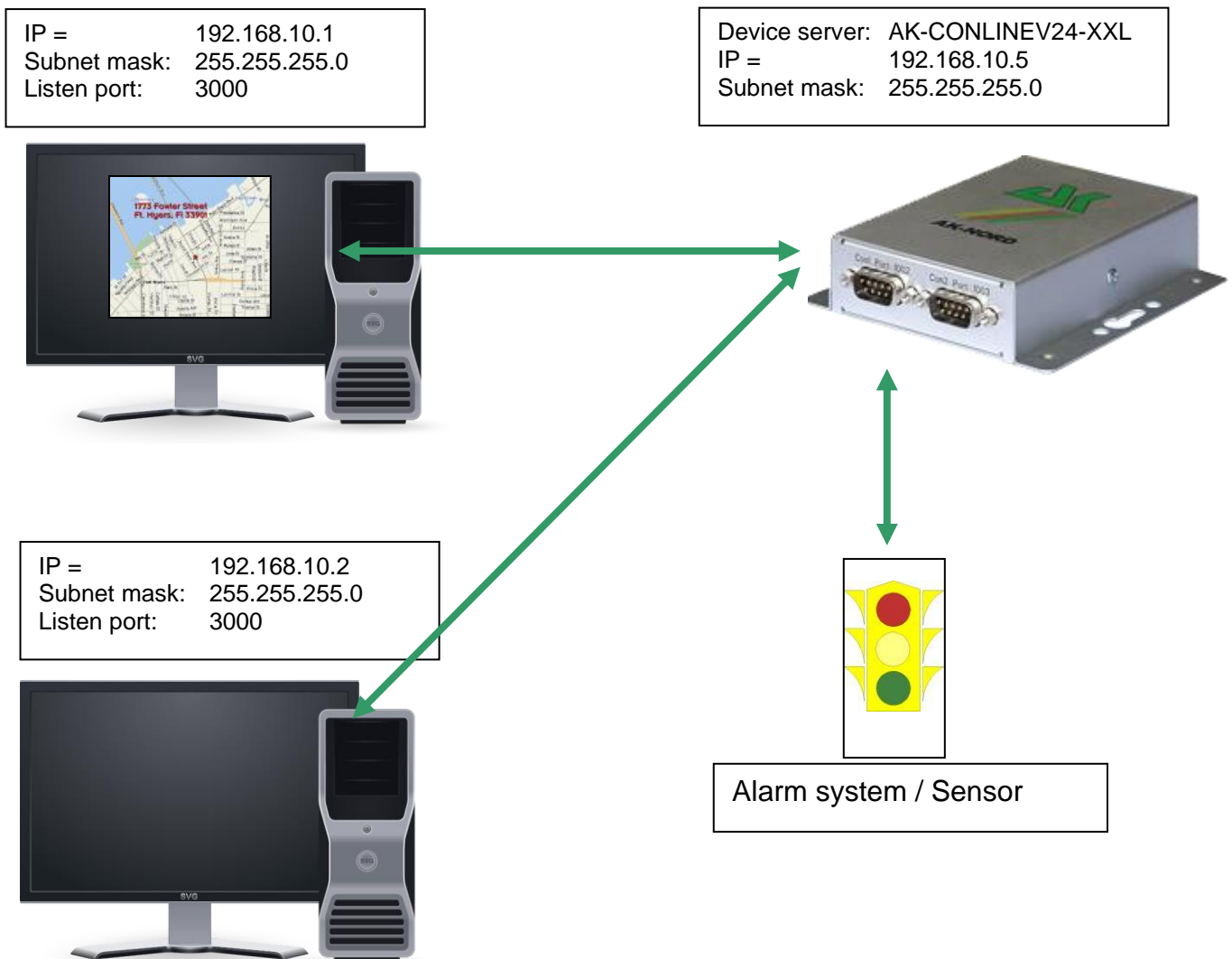

Examples of applications

Configuration:

Establish a connection to the interface via Telnet or Browser. Then select the “INTERFACE Menu” and select the menu of the interface, e.g. “SERIAL1 Menu“. Then select the “SERIAL Destination Menu“.

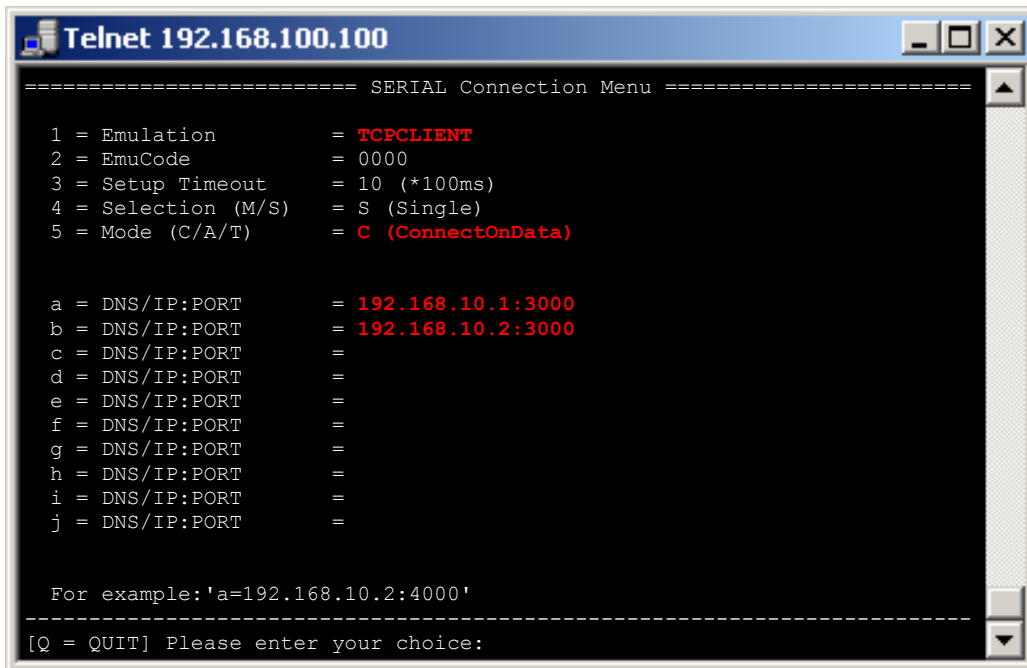

```
Telnet 192.168.100.100
===== SERIAL Connection Menu =====
 1 = Emulation           = TCPCLIENT
 2 = EmuCode             = 0000
 3 = Setup Timeout       = 10 (*100ms)
 4 = Selection (M/S)     = S (Single)
 5 = Mode (C/A/T)       = C (ConnectOnData)

 a = DNS/IP:PORT        = 192.168.10.1:3000
 b = DNS/IP:PORT        = 192.168.10.2:3000
 c = DNS/IP:PORT        =
 d = DNS/IP:PORT        =
 e = DNS/IP:PORT        =
 f = DNS/IP:PORT        =
 g = DNS/IP:PORT        =
 h = DNS/IP:PORT        =
 i = DNS/IP:PORT        =
 j = DNS/IP:PORT        =

For example: 'a=192.168.10.2:4000'
-----
[Q = QUIT] Please enter your choice:
```

Setup Timeout :

In this case it is being tried to establish a connection for 1 second.



Note:

If you are working with static IP addresses, set the parameter DHCP (NETWORK MENU → DHCP -MENU) to “N“. If it is set to “Y“ and you do not assign any IP address to the interface, ConnectOnData will not work.

Examples of applications

TCPSERVER

Short description:

TCPSERVER is entered as a standard for the AK-XXL products. With this operating mode it is possible to transfer data to the serial interface via the device server. The AK-XXL product has got a passive role and is waiting for incoming connections. If a connection had been established, this connection is bidirectional and transparent. When a connection is established data can be sent from the interface to the PC as well as from the PC to the interface. This connection remains established until the Port-Timeout (NETWORK – Menu → TCP menu) has elapsed after having sent or received the last character.

Example:

The task is to pick up data from a PC using a software from a time and attendance terminal.

In this case it is not necessary to set a target in the AK-XXL product. If the application wants to call the data, the application will establish a connection to the IP address and to the TCP port 1002 of the AK-XXL product. As soon as the connection had been established, the software can communicate transparently and bidirectionally with the time and attendance terminal.

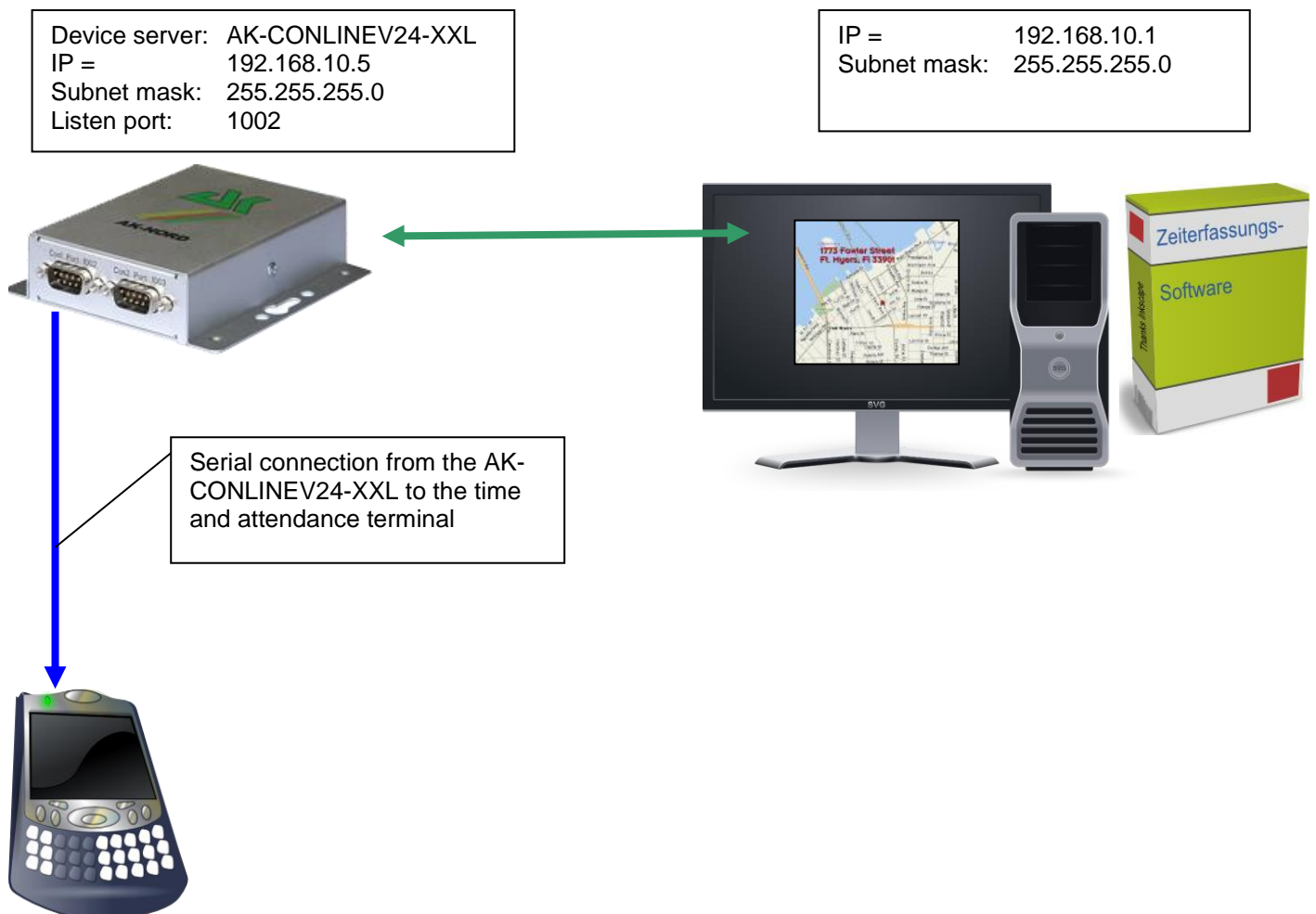

Examples of applications

Configuration:

Establish a connection to the interface via Telnet or browser. Then select the “INTERFACE Menu“, finally select the menu of the interface, e.g. “SERIAL1 Menu“. Then select the “SERIAL Config Menu“.

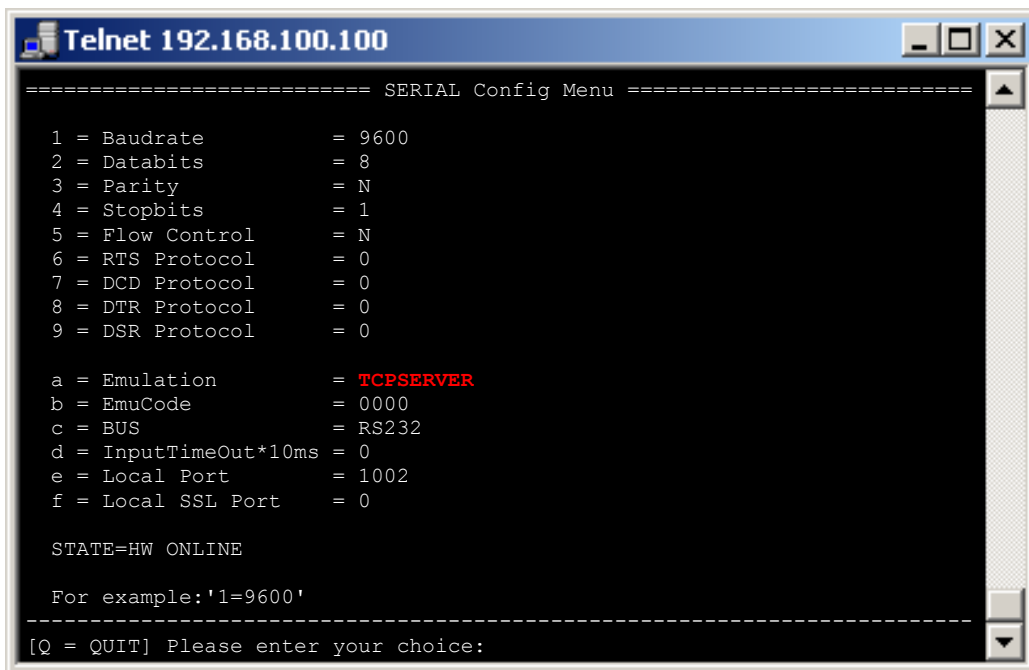

```
Telnet 192.168.100.100
===== SERIAL Config Menu =====
1 = Baudrate           = 9600
2 = Databits           = 8
3 = Parity              = N
4 = Stopbits           = 1
5 = Flow Control       = N
6 = RTS Protocol       = 0
7 = DCD Protocol       = 0
8 = DTR Protocol       = 0
9 = DSR Protocol       = 0

a = Emulation          = TCPSERVER
b = EmuCode            = 0000
c = BUS                = RS232
d = InputTimeOut*10ms = 0
e = Local Port         = 1002
f = Local SSL Port     = 0

STATE=HW ONLINE

For example:'1=9600'
-----
[Q = QUIT] Please enter your choice:
```



Note:

If the application is not directly network-compliant, but only supports COM ports, use our AK-VirtualCOM software. Using this software, it is possible to create virtual COM interfaces on a MICROSOFT WINDOWS PC (from Windows 2000 .NET 2.0 on). They are redirected to the AK-XXL products via the network.

The AK-VirtualCOM software can be downloaded from the regular AK-Nord website.

Please find examples of applications in the AK-VirtualCOM manual.

Examples of applications

UDPCIENT

Short description:

Using this operating mode, you can transfer data to a network target via a device server. In this case, the AK-XXL product has got an active role and will send data to one or several network targets. UDP does not have a connection as TCP. The receipt of data packages will not be acknowledged and data cannot be transferred bidirectionally. This is not provided for regular data transfer since data might get lost unnoticed. UDP is a little more rapid than TCP due to its little protocol efforts and it is possible to send broadcast data packages.

Example:

A serially controlled video camera shall send image data via the network to a PC by means of a ComPoint-LAN-XXL. To do so, a UDP target is entered in the "SERIAL Destination Menu".

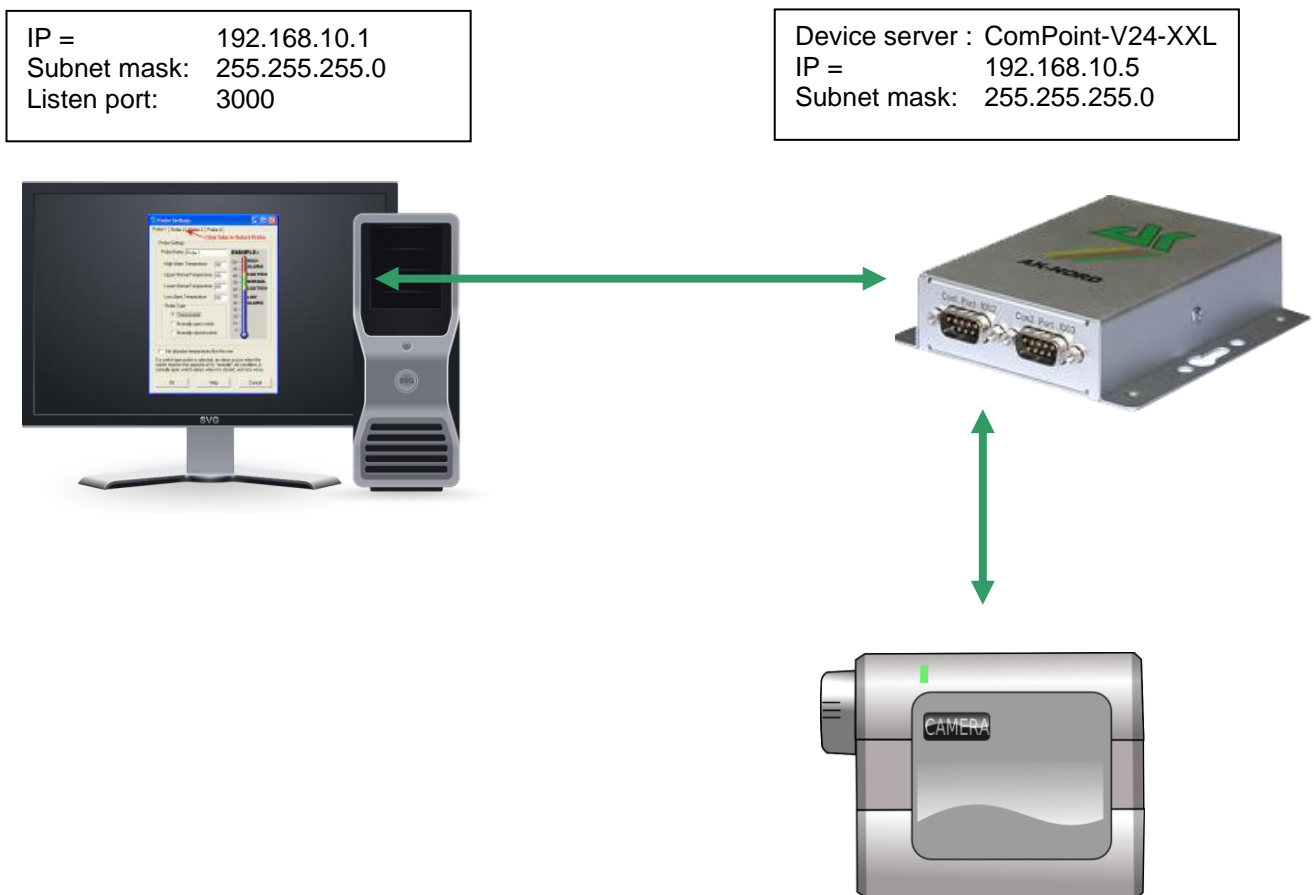

Examples of applications

Configuration:

Establish a connection to the interface via Telnet or browser. Then select the “INTERFACE Menu”, then select the menu of the interface, e.g. “SERIAL1 Menu“. Then select the “SERIAL Destination Menu“.

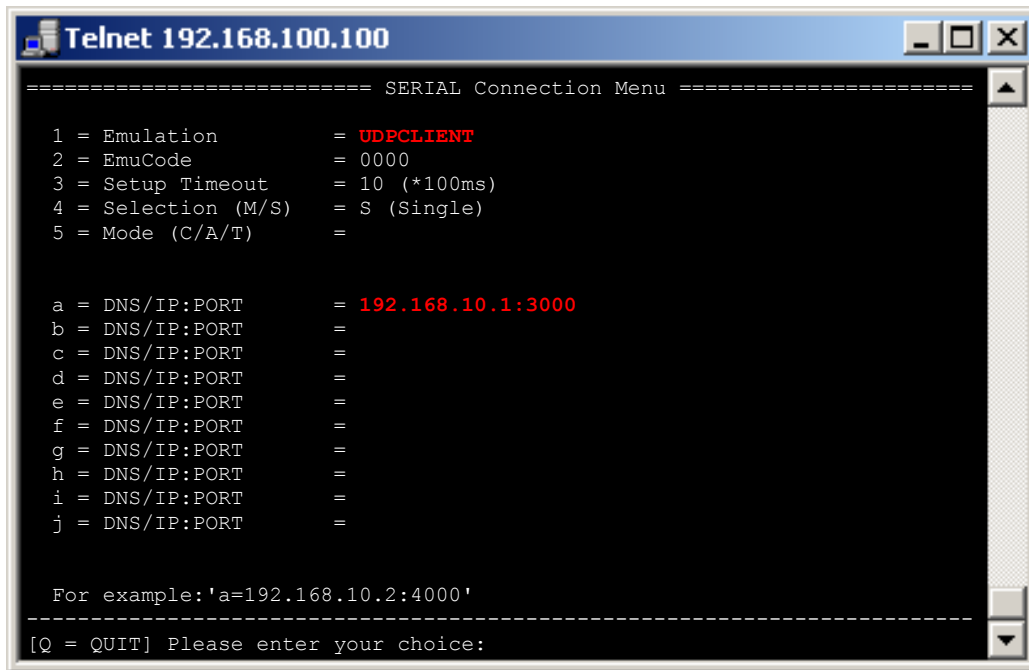

```
Telnet 192.168.100.100
===== SERIAL Connection Menu =====
1 = Emulation           = UDPCCLIENT
2 = EmuCode             = 0000
3 = Setup Timeout       = 10 (*100ms)
4 = Selection (M/S)     = S (Single)
5 = Mode (C/A/T)       =

a = DNS/IP:PORT        = 192.168.10.1:3000
b = DNS/IP:PORT        =
c = DNS/IP:PORT        =
d = DNS/IP:PORT        =
e = DNS/IP:PORT        =
f = DNS/IP:PORT        =
g = DNS/IP:PORT        =
h = DNS/IP:PORT        =
i = DNS/IP:PORT        =
j = DNS/IP:PORT        =

For example: 'a=192.168.10.2:4000'
-----
[Q = QUIT] Please enter your choice:
```

Examples of applications

AutoConnect

Short description:

The emulation AutoConnect is used in order to establish a connection to a predefined target after switching on the interface. All connection data are stored in the interface. The connection is bidirectional and transparent. As long as a connection is established data can be sent from the interface to the PC, as well as from the PC to the interface. This connection remains established until one of the devices is switched off.

Example:

A thermometer shall be able to continuously send its measured values to a PC. After having switched on the device server, a connection will automatically be established to the server 192.168.10.1 and all data which the device server receives will be directly send to port 3000.

IP =	192.168.10.1
Subnet mask:	255.255.255.0
Listen port:	3000

Device server :	ComPoint-XXL-AS
IP =	192.168.10.5
Subnet mask:	255.255.255.0

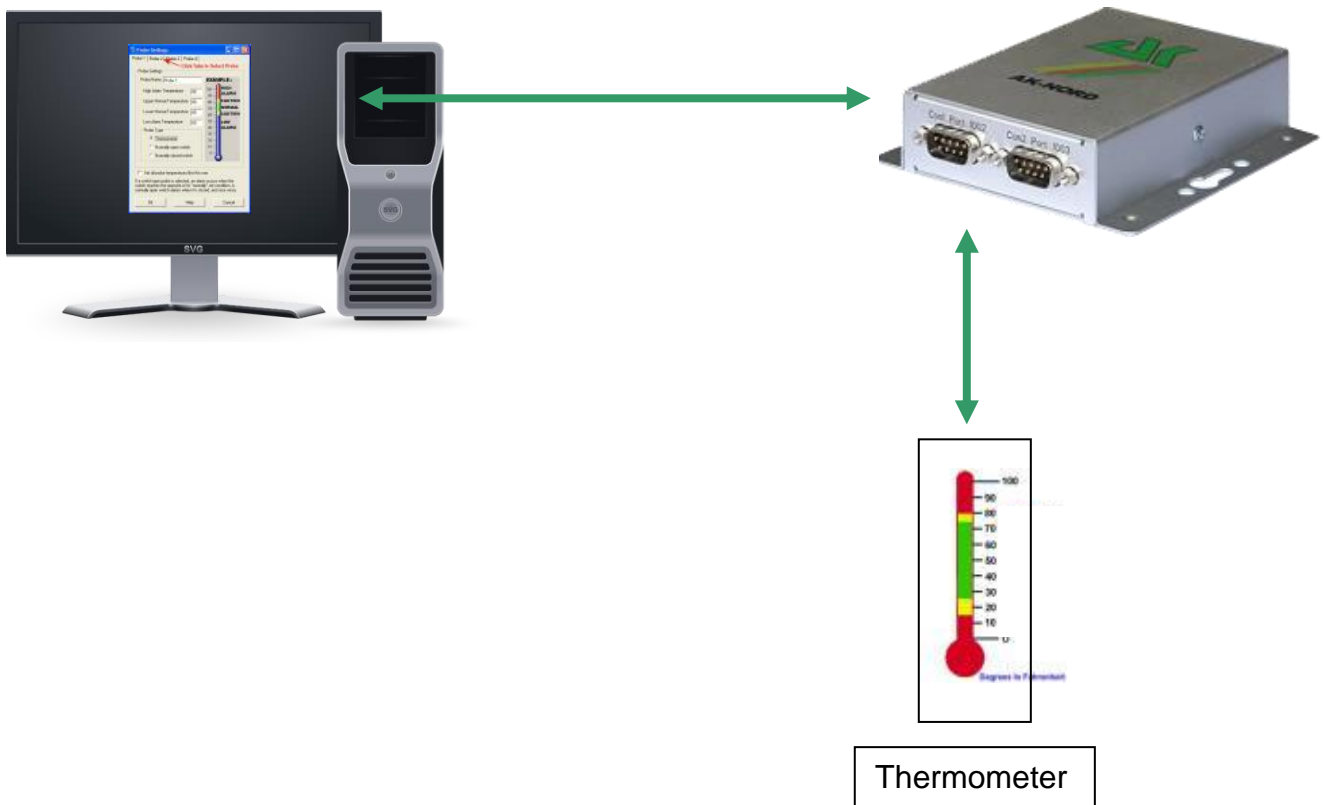

Examples for applications

Configuration:

Establish a connection to the interface via Telnet or browser. Then select the “INTERFACE Menu“, then select the menu of the interface, e.g. “SERIAL1 Menu“. Then

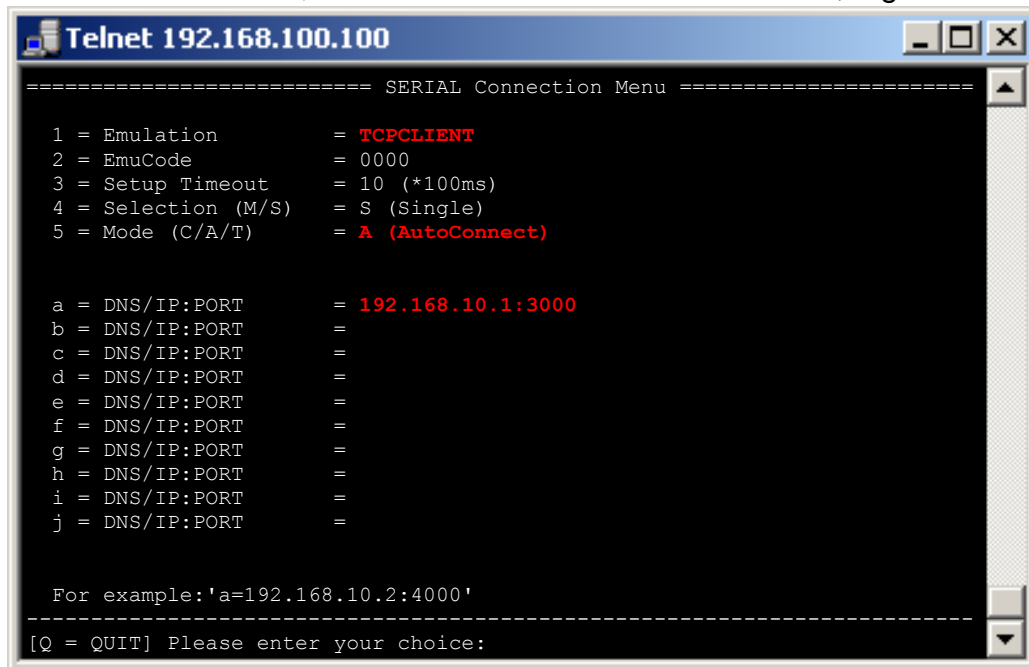

```
Telnet 192.168.100.100
===== SERIAL Connection Menu =====
1 = Emulation           = TCPCLIENT
2 = EmuCode             = 0000
3 = Setup Timeout       = 10 (*100ms)
4 = Selection (M/S)     = S (Single)
5 = Mode (C/A/T)       = A (AutoConnect)

a = DNS/IP:PORT         = 192.168.10.1:3000
b = DNS/IP:PORT         =
c = DNS/IP:PORT         =
d = DNS/IP:PORT         =
e = DNS/IP:PORT         =
f = DNS/IP:PORT         =
g = DNS/IP:PORT         =
h = DNS/IP:PORT         =
i = DNS/IP:PORT         =
j = DNS/IP:PORT         =

For example: 'a=192.168.10.2:4000'
-----
[Q = QUIT] Please enter your choice:
```



Note 1:

As soon as AutoConnect is activated, the procedure TCP-Checkline (NETWORK MENU → TCP-MENU) will be activated. I.e. the interface checks if there is a connection to the target. If the PC had been switched off, the Port-Timeout (NETWORK MENU → TCP-MENU) will automatically proceed. The interface terminates the connection when the time has elapsed and will then immediately try to establish a new connection.

Note 2:

If you are working with static IP addresses, set the parameter DHCP (NETWORK MENU → DHCP -MENU) to “N“. If it is set to “Y“ and you do not assign any IP address to the interface ConnectOnData will not work.

Examples of applications

MULTI-Connect

Short description:

MULTI-CONNECT is used in order to send the data which are incoming on the serial interface to several targets at the same time. The connection is NOT bidirectional. This function can be used for the TCP as well as for the UDP protocol. To do so, only the emulation has to be switched over from TCPCLIENT to UDPCLIENT. A DNS name or an IP address with additional indication of the TCP or UDP port may serve as target. This connection will remain established until one of the devices is being switched of.

Example:

A thermometer shall be able to continuously send its measured values to a PC. After having switched on the device server, a connection will automatically be established to the server 192.168.10.1 and all data which the device server receives will be directly send to port 3000.

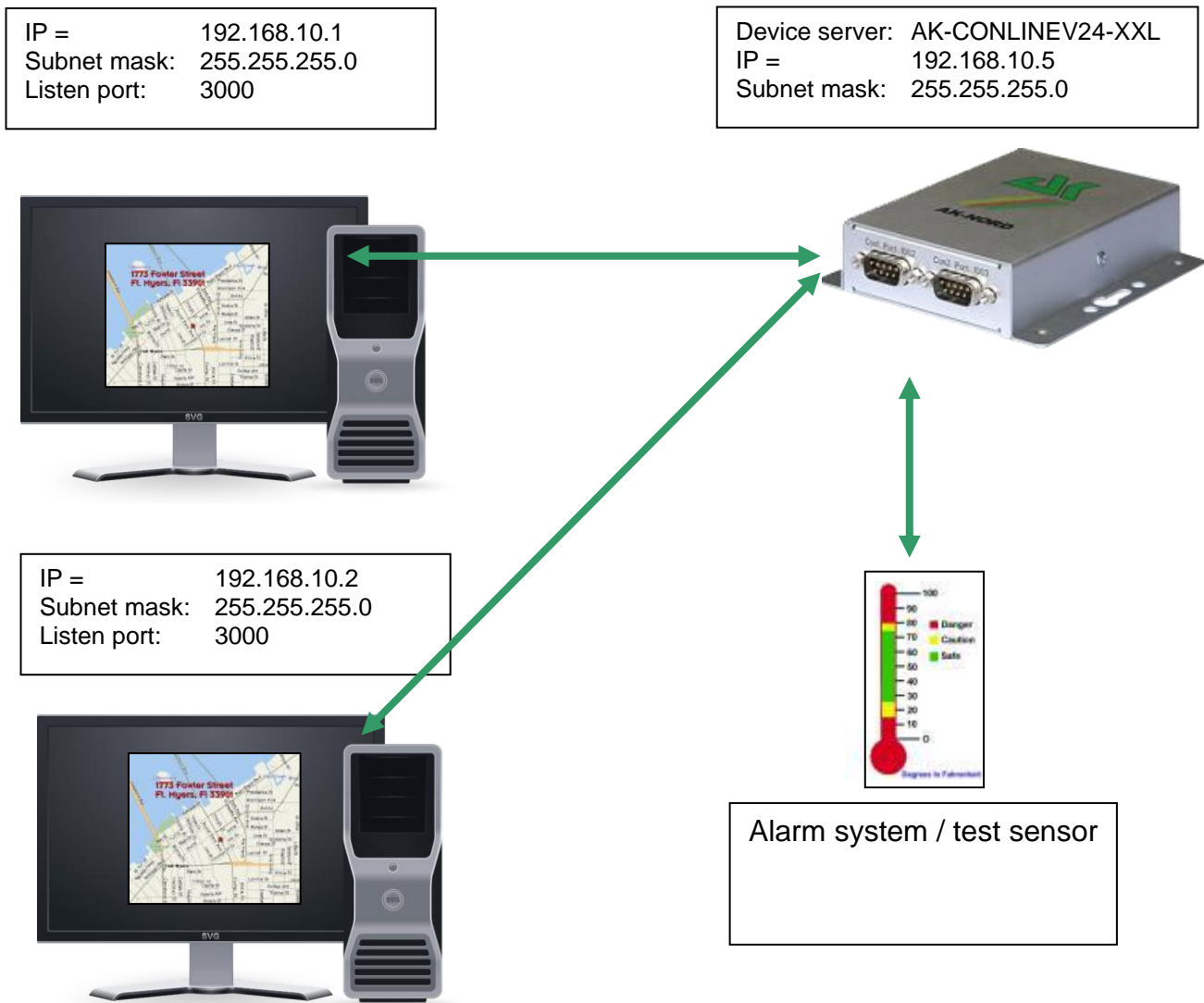

Examples for applications

Configuration:

Establish a connection to the interface via Telnet or browser. Then select the “INTERFACE Menu“, then select the menu of the interface, e.g. “SERIAL1 Menu“. Then select the “SERIAL Destination Menu“.

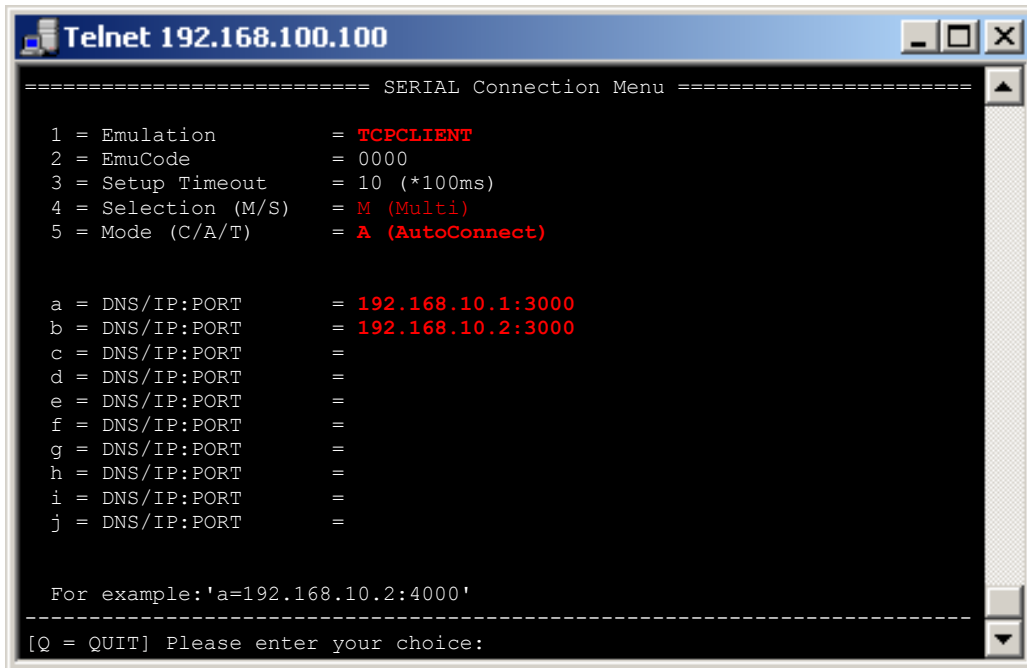

```
Telnet 192.168.100.100
===== SERIAL Connection Menu =====
1 = Emulation           = TCPCLIENT
2 = EmuCode             = 0000
3 = Setup Timeout       = 10 (*100ms)
4 = Selection (M/S)     = M (Multi)
5 = Mode (C/A/T)        = A (AutoConnect)

a = DNS/IP:PORT         = 192.168.10.1:3000
b = DNS/IP:PORT         = 192.168.10.2:3000
c = DNS/IP:PORT         =
d = DNS/IP:PORT         =
e = DNS/IP:PORT         =
f = DNS/IP:PORT         =
g = DNS/IP:PORT         =
h = DNS/IP:PORT         =
i = DNS/IP:PORT         =
j = DNS/IP:PORT         =

For example: 'a=192.168.10.2:4000'
-----
[Q = QUIT] Please enter your choice:
```

Setup Timeout :

In this case it is being tried to establish a connection for 1 second.



Note:

If you are working with static IP addresses, set the parameter DHCP (NETWORK MENU → DHCP -MENU) to “N“. If it is set to “Y“ and you do not assign any IP address to the interface ConnectOnData will not work.

Examples for applications

Tunnel emulation (cable replacement)

Short description:

Using the tunnel emulation it is possible to make available a transparently and bidirectionally serial cable replacement. To do so, characters can be transmitted in addition to the properly transmitted data. It allows to switch the signal lines such as RTS, CTS, etc.

Example:

A machine control software requires a special response via signal lines for the data transfer in order that it is working properly. In order to guarantee this, the tunnel mode is being used.

The machine control software shall transmit the consumption data from the machine to the PC once per day. In order to use the tunnel emulation, use 2 AK-XXL products. The XT-NANO-XXL with the IP address 192.168.10.5 will automatically establish a connection to ComPoint-LAN -V24-XXL with the IP address 192.168.10.4 and the port 1002 after the start-up. As soon as the connection is established, the XT-NANO-XXL will not only send the data of the machine, but also the changes in the signal lines via the network to the ComPoint-LAN -XXL.

Device server:	XT-NANO-XXL
IP =	192.168.10.5
Subnet mask:	255.255.255.0

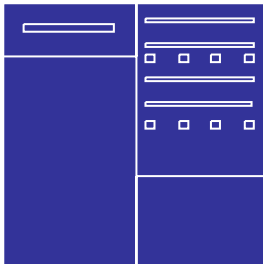

Device server:	AK-CONLNE-V24-XXL
IP =	192.168.10.4
Subnet mask:	255.255.255.0
Listen port:	1002

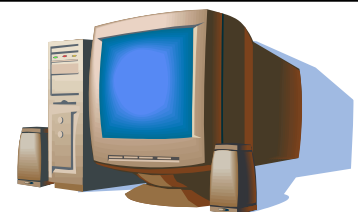

Examples for applications

Configuration:

Establish a connection to the interface via Telnet or browser. Then select the “INTERFACE Menu“, then select the menu of the interface, e.g. “SERIAL1 Menu“. Then select the “SERIAL Destination Menu“.

ComPoint-LAN -XXL configuration

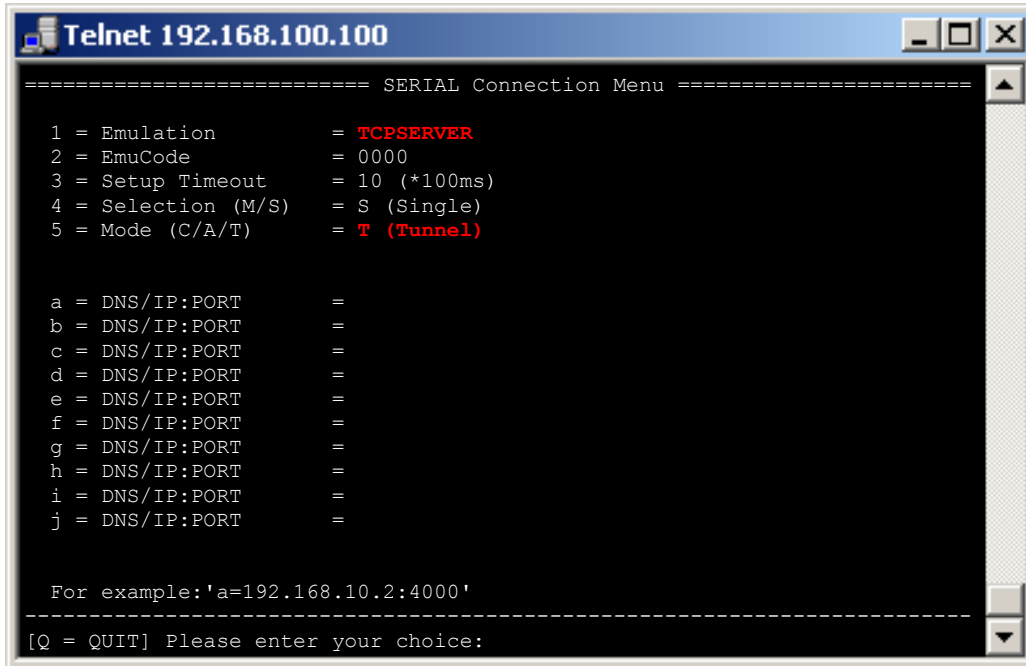

```
Telnet 192.168.100.100
===== SERIAL Connection Menu =====
1 = Emulation           = TCPSERVER
2 = EmuCode             = 0000
3 = Setup Timeout       = 10 (*100ms)
4 = Selection (M/S)     = S (Single)
5 = Mode (C/A/T)        = T (Tunnel)

a = DNS/IP:PORT         =
b = DNS/IP:PORT         =
c = DNS/IP:PORT         =
d = DNS/IP:PORT         =
e = DNS/IP:PORT         =
f = DNS/IP:PORT         =
g = DNS/IP:PORT         =
h = DNS/IP:PORT         =
i = DNS/IP:PORT         =
j = DNS/IP:PORT         =

For example:'a=192.168.10.2:4000'
-----
[Q = QUIT] Please enter your choice:
```

XT-NANO-XXL configuration

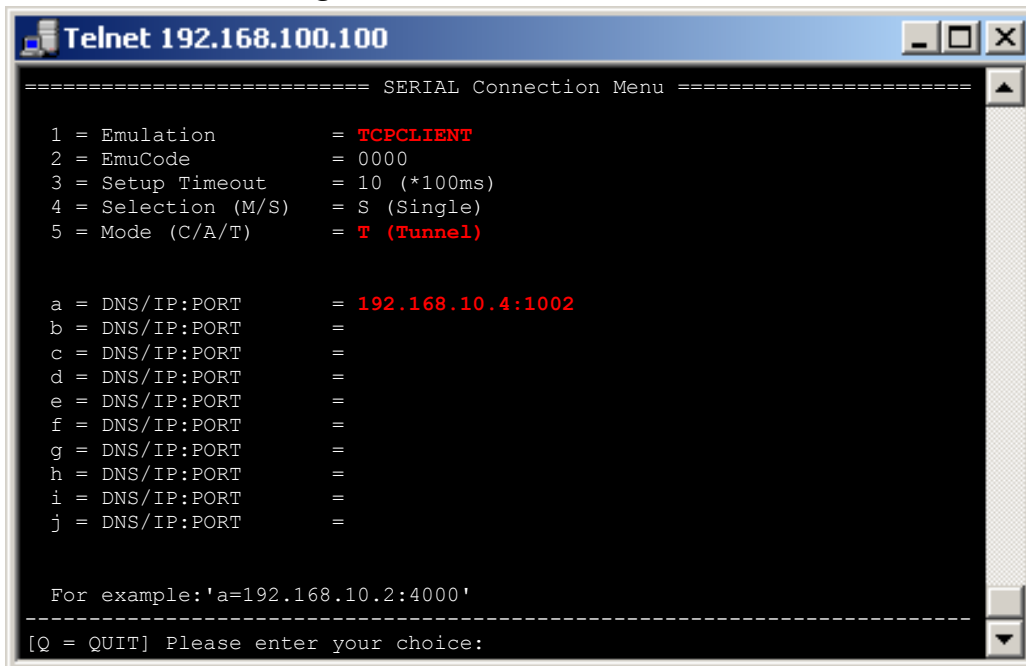

```
Telnet 192.168.100.100
===== SERIAL Connection Menu =====
1 = Emulation           = TCPCLIENT
2 = EmuCode             = 0000
3 = Setup Timeout       = 10 (*100ms)
4 = Selection (M/S)     = S (Single)
5 = Mode (C/A/T)        = T (Tunnel)

a = DNS/IP:PORT         = 192.168.10.4:1002
b = DNS/IP:PORT         =
c = DNS/IP:PORT         =
d = DNS/IP:PORT         =
e = DNS/IP:PORT         =
f = DNS/IP:PORT         =
g = DNS/IP:PORT         =
h = DNS/IP:PORT         =
i = DNS/IP:PORT         =
j = DNS/IP:PORT         =

For example:'a=192.168.10.2:4000'
-----
[Q = QUIT] Please enter your choice:
```

Examples for applications

Modem emulation

Short description:

The modem emulation offers the option to completely control the terminal which is connected to the AK-NORD interfaces. It is possible to assign an IP address, gateway, a subnet mask, port, etc. to the AK-NORD interface and to transfer a connection requirement. The terminal can also establish a connection to different targets in the network and finally terminate them.

Example:

A machine control shall send its consumption data to the PC 192.168.10.1 once per day and immediately notify any malfunctions which are determined to the Support PC 192.168.10.2. If the machine control determines a problem via its transducer, it will send the modem command "ATDi192.168.10.2p3000" to the interface and will obtain a reply "Connect" as soon as the connection had been successfully established. From now on the connection is ready to transfer data and the machine control can transfer the malfunction.

IP =	192.168.10.1
Subnet mask:	255.255.255.0
Listen port:	3000

Device server:	XT-Nano
IP =	192.168.10.5
Subnet mask:	255.255.255.0

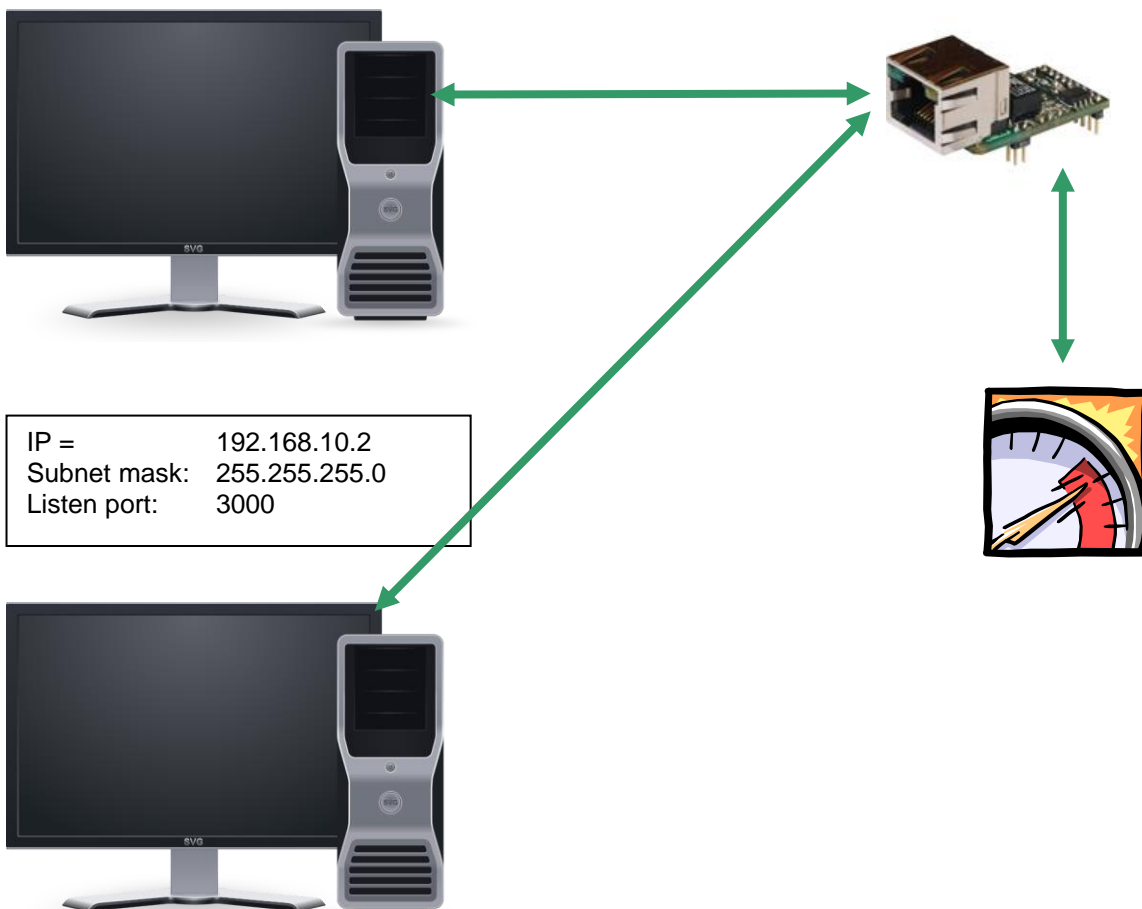

Examples for applications

Configuration:

Establish a connection to the interface via Telnet or browser. Then select the “INTERFACE MENU“, then the “SERIAL1 MENU“ and then the “SERIAL Config Menu“.

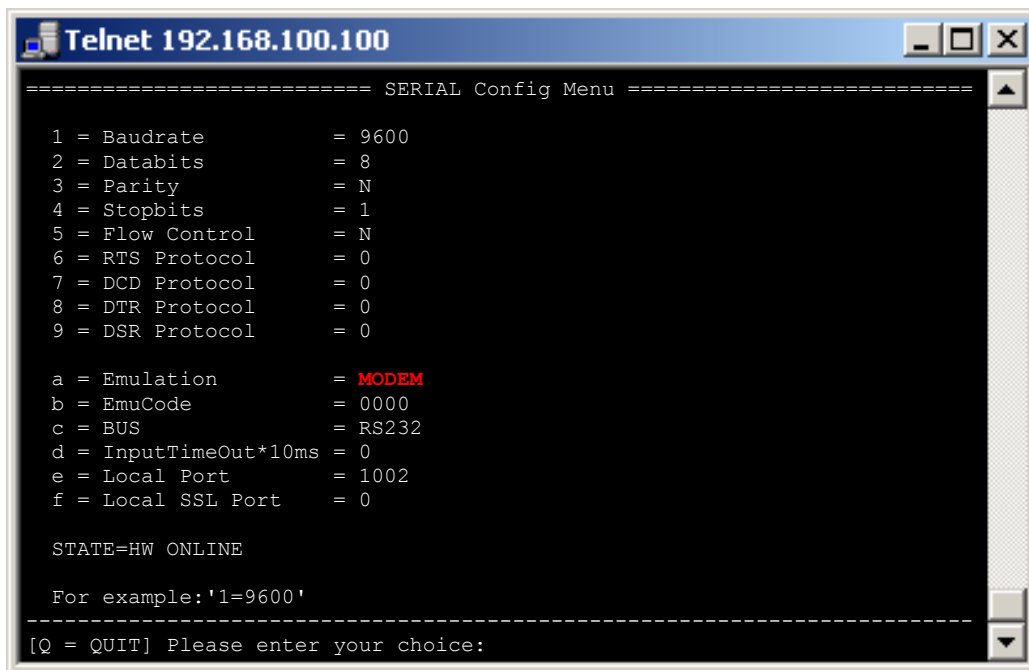

```
Telnet 192.168.100.100
===== SERIAL Config Menu =====
1 = Baudrate           = 9600
2 = Databits           = 8
3 = Parity              = N
4 = Stopbits           = 1
5 = Flow Control       = N
6 = RTS Protocol       = 0
7 = DCD Protocol       = 0
8 = DTR Protocol       = 0
9 = DSR Protocol       = 0

a = Emulation          = MODEM
b = EmuCode            = 0000
c = BUS                = RS232
d = InputTimeOut*10ms = 0
e = Local Port         = 1002
f = Local SSL Port     = 0

STATE=HW ONLINE

For example: '1=9600'
-----
[Q = QUIT] Please enter your choice:
```



Note 1:

If you are working with static IP addresses, set the parameter DHCP (NETWORK MENU → DHCP -MENU) to “N“. If it is set to “Y“ and you do not assign any IP address to the interface MODEM emulation will not work.

Note 2:

Set DSR to 2. Then you can trigger the termination of the connection by changing the signal on the DSR line. (HIGH, LOW, HIGH)

Note 3:

All commands of the modem emulation are included in the manual “[at_befehle_xtmicro.pdf](#)“. This manual also applies for the AK-XXL products.

Examples for applications

E-mail-Emulation (Software)

Short description:

Using the e-mail emulation it is possible to send e-mails via the AK-XXL products with the help of the SMTP protocol. To do so, the recipient address can be either firmly entered or transmitted to the interface together with the data/messages. Different formats of outgoing e-mails are allowed. Such formats are HTML, TEXT and ATTACHEMENT. In our example we are using an ATTACHMENT.

Example:

A cooling appliance shall send its temperature to the recipient **info@ak-nord.de** once per day. To do so, the address is firmly set in the menu. In addition any malfunction notifications shall be send to **technik@ak-nord.de**. In this case, the recipient address will be transmitted together with the data/messages.

In case of a malfunction the following data will be serially transmitted to the device server:

```
<technik@ak-nord.de>  
This is a test message
```

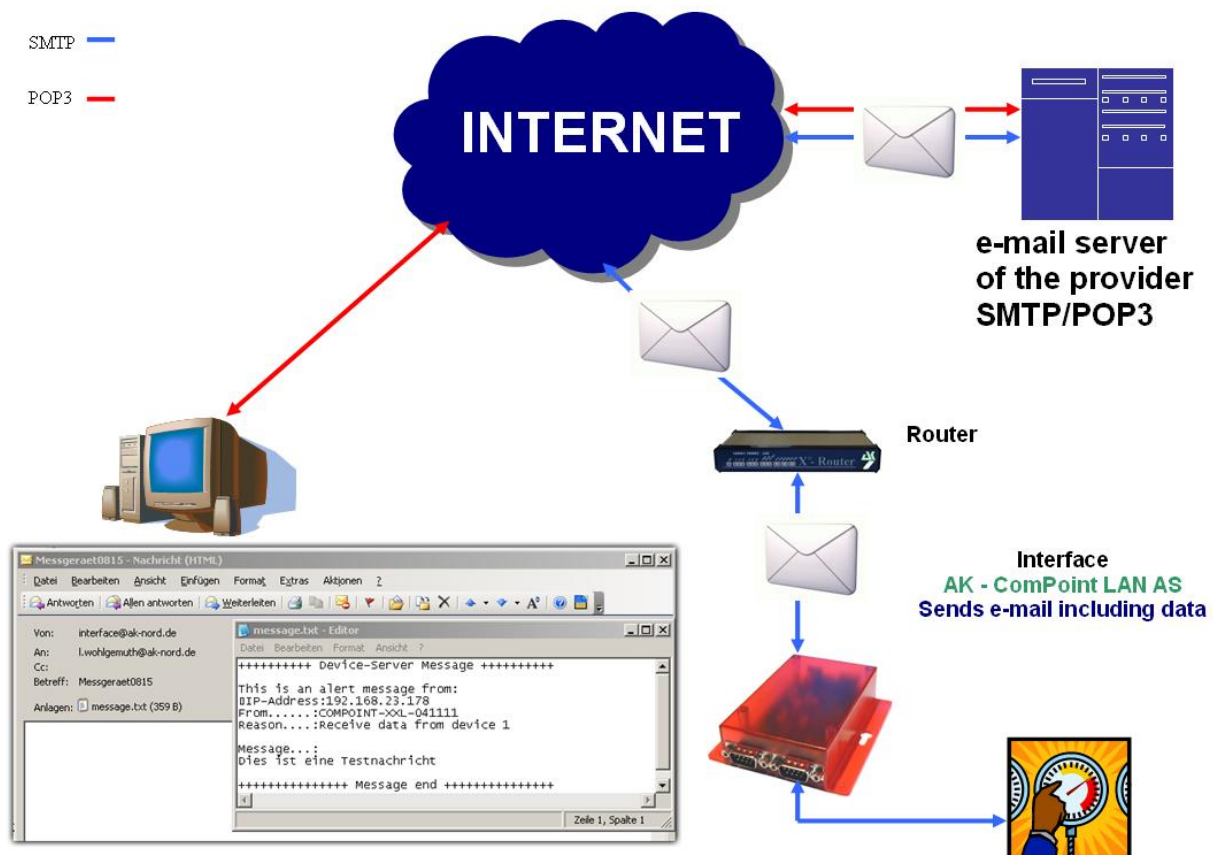

Examples for applications

Configuration:

Establish a connection to the interface via Telnet or browser. Then select the “INTERFACE MENU“, then the “SERIAL1 MENU“ and then the “SERIAL Config Menu“.

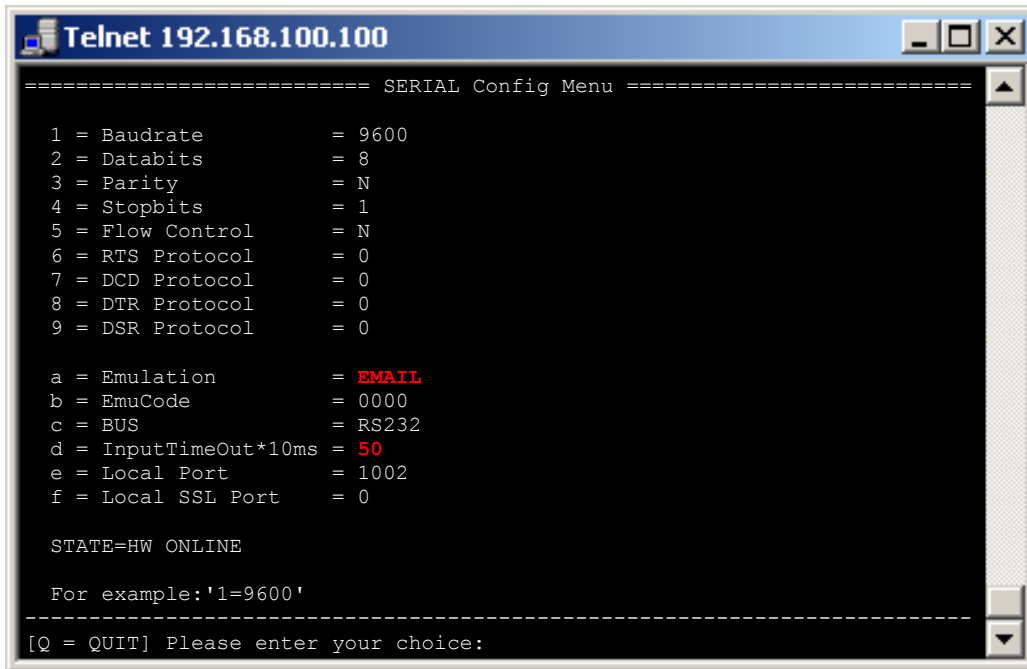

```
Telnet 192.168.100.100
===== SERIAL Config Menu =====
1 = Baudrate           = 9600
2 = Databits           = 8
3 = Parity              = N
4 = Stopbits           = 1
5 = Flow Control       = N
6 = RTS Protocol       = 0
7 = DCD Protocol       = 0
8 = DTR Protocol       = 0
9 = DSR Protocol       = 0

a = Emulation           = EMAIL
b = EmuCode             = 0000
c = BUS                 = RS232
d = InputTimeOut*10ms  = 50
e = Local Port         = 1002
f = Local SSL Port     = 0

STATE=HW ONLINE

For example:'1=9600'
-----
[Q = QUIT] Please enter your choice:
```



Note 1:

For a mail server outside of your network, the standard gateway and a DNS server are imperatively required in order to guarantee the communication. You will find setting options in the menu “IP“ and “DNS“ below the “NETWORK MENU“.

Note 2:

*The option InputTimeOut*10ms control the queue time of the AK-XXL product. After the first character, the period of time starts to elapse. As soon as the period of time has elapsed, an e-mail will be sent and confirmed with an “OK“ by the interface.*

HEX feedback: 0x4F 0x4B 0x0D 0x0A

Note 3:

If you are working with static IP addresses, set the parameter DHCP (NETWORK MENU → DHCP -MENU) to “N“. If it is set to “Y“ and you do not assign any IP address to the interface, email emulation will not work.

Examples of an application

```
Telnet 192.168.100.100
===== SMTP MENU =====
1 = SMTP (Y/N)           = Y
2 = SEND AS              = ATTACHEMENT
3 = SMTP SERVER          = asmtt.t-online.de
4 = USER                 = interface@ak-nord.de
5 = PASSWORD              = *****
6 = PORT                  = 25
7 = HTML LOGO            = http://www.ak-nord.de/xxl/logo.gif
8 = EMAIL FROM           = interface@ak-nord.de
9 = EMAIL SUBJECT        = Messgeraet0815
A = EMAIL ADDRESS1       = info@ak-nord.de
B = EMAIL ADDRESS2       =
C = EMAIL ADDRESS3       =
Last State               = RUNNING
                          Last Mail
To                        =
Message                   =
For example: '1=Y'
=====
[Q = QUIT] Please enter your choice:
```



Note 4:

The values of the options “4 = USER” and “8 = EMAIL FROM” are the same for some providers. In spite of that, both values need to be entered. Depending on the e-mail system, the user may also be completely different from the sender address.

Application examples

E-mail-Emulation (Hardware)

Short description:

With the E-mail emulation it would be possible to send e-mails via the AK-XXL/SXL products with the help of the SMTP protocol. Different formats of outgoing e-mails are possible. These are HTML, TEXT and ATTACHEMENT. In our example we will represent it through a text message.

Example:

After the failure of an air-conditioning a failure e-mail to the responsible service centre will be sent via a potential-free alarm relay. To do so, you need to execute the corresponding settings.

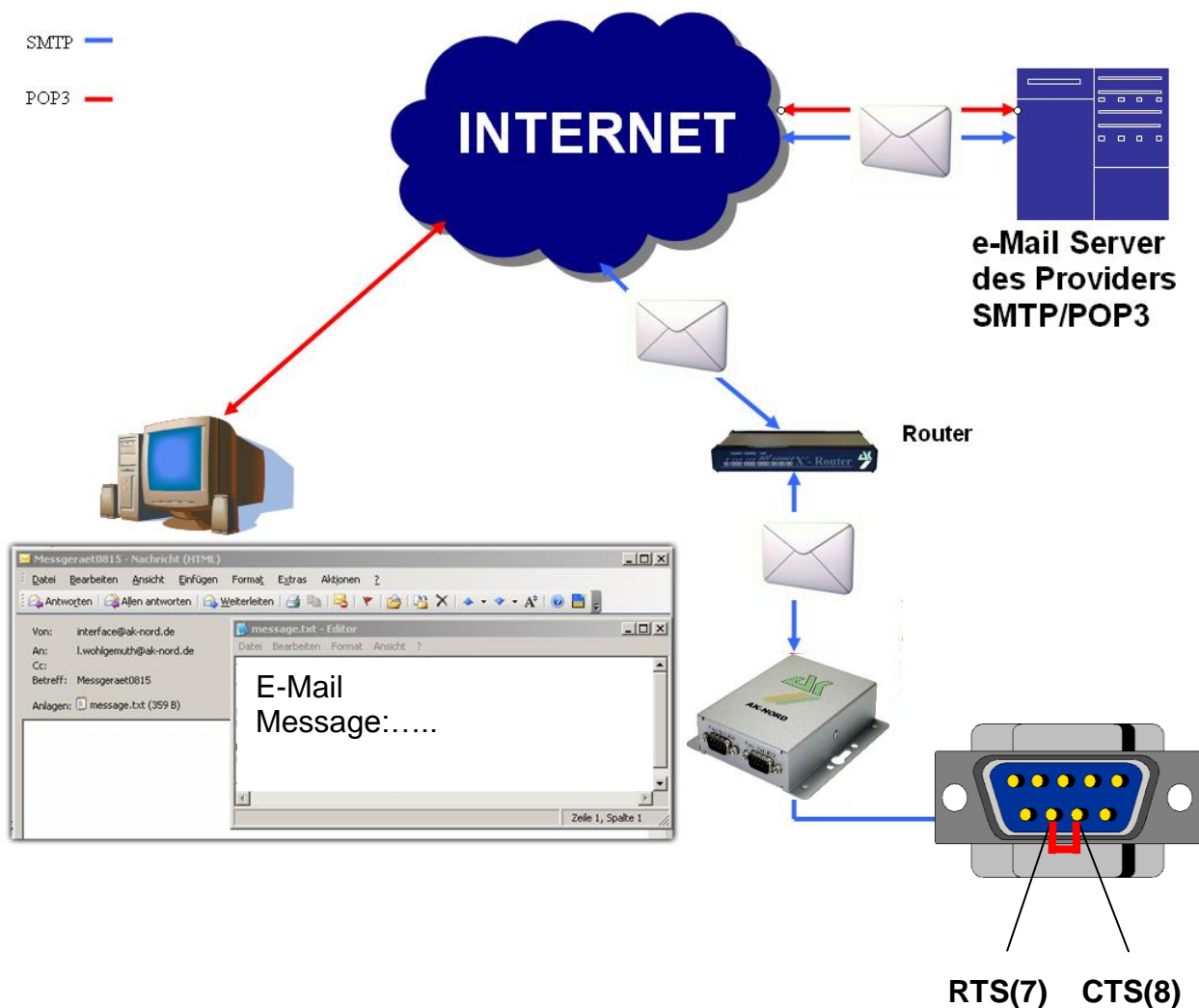

Application examples

Configuration:

Connect to the interface through Telnet or the browser. Then select the “INTERFACE – MENU”, thereafter select the “SERIAL1 MENU” and then the “SERIAL Alert Menu”. Then, configure the contact to be used.

(INTERFACE–MENU → SERIAL-MENU → ALERT-MENU)

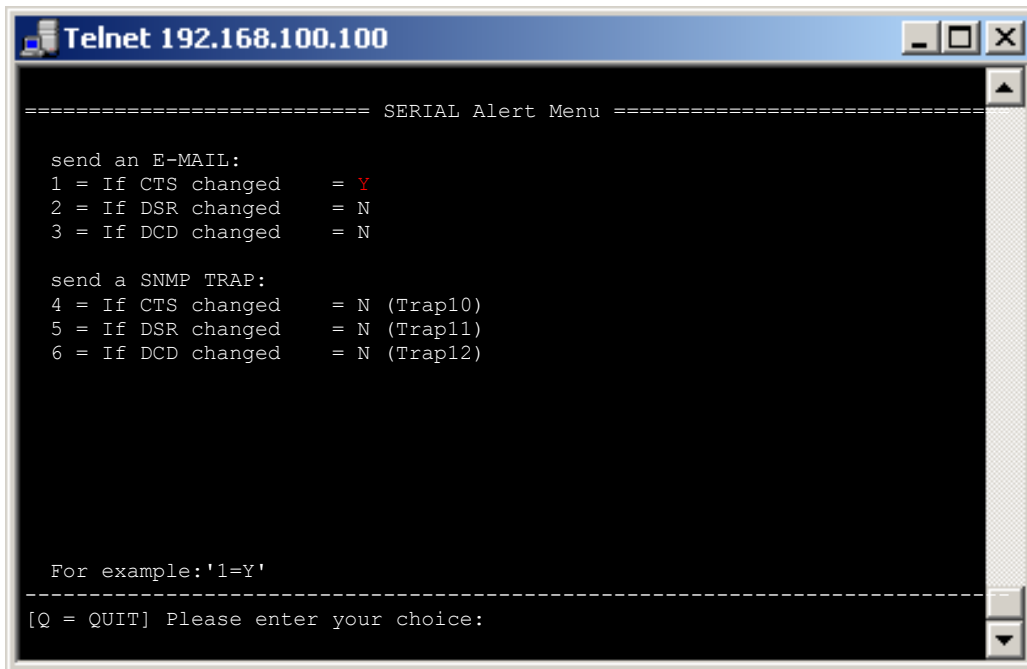

```
Telnet 192.168.100.100
===== SERIAL Alert Menu =====

send an E-MAIL:
1 = If CTS changed      = Y
2 = If DSR changed      = N
3 = If DCD changed      = N

send a SNMP TRAP:
4 = If CTS changed      = N (Trap10)
5 = If DSR changed      = N (Trap11)
6 = If DCD changed      = N (Trap12)

For example: '1=Y'
-----
[Q = QUIT] Please enter your choice:
```



Note1:

If you are working with firm IP addresses, set the parameter DHCP (NETWORK – MENU → DHCP -MENU) to “N”. If it is set to “Y” and no IP address is assigned to the interface, the e-mail emulation will not work.

Note2:

Make sure that the parameters

- | | |
|--------------------|---------------------------|
| -IP address | (NETWORK–MENU → IP-MENU) |
| -Gateway | (NETWORK–MENU → IP-MENU) |
| -Subnetmask | (NETWORK–MENU → IP-MENU) |
| -DNS-Server | (NETWORK–MENU → DNS-MENU) |

are correctly filled in and set.

Application examples

(NETWORK-MENU → SMTP-MENU)

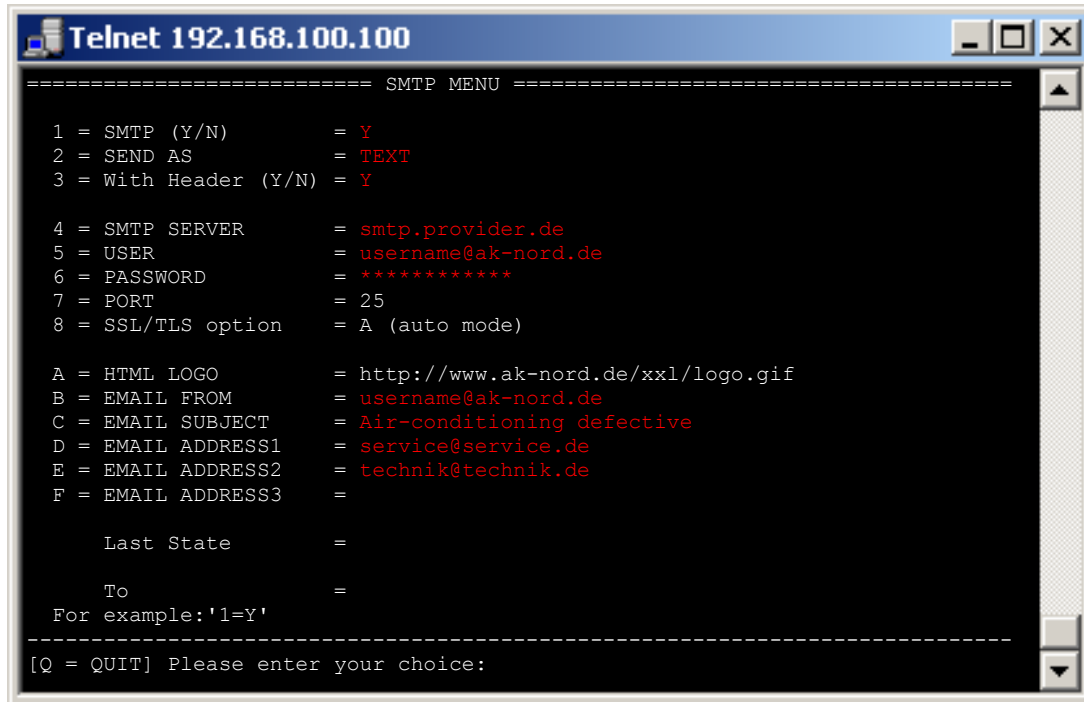

```
Telnet 192.168.100.100
----- SMTP MENU -----
1 = SMTP (Y/N)           = Y
2 = SEND AS              = TEXT
3 = With Header (Y/N)   = Y

4 = SMTP SERVER          = smtp.provider.de
5 = USER                 = username@ak-nord.de
6 = PASSWORD             = *****
7 = PORT                 = 25
8 = SSL/TLS option       = A (auto mode)

A = HTML LOGO            = http://www.ak-nord.de/xxl/logo.gif
B = EMAIL FROM          = username@ak-nord.de
C = EMAIL SUBJECT       = Air-conditioning defective
D = EMAIL ADDRESS1      = service@service.de
E = EMAIL ADDRESS2      = technik@technik.de
F = EMAIL ADDRESS3      =

Last State              =

To                      =

For example: '1=Y'

-----
[Q = QUIT] Please enter your choice:
```



Note1:

The values of the options “5 = USER” and “B = EMAIL FROM” are the same for some providers. Nonetheless, it is necessary to enter it for both. Depending on the e-mailing system, the user (USER) can also be completely different from the sender address.

Note2:

The XXL series can only send unencrypted e-mails (port 25). The SXL series can send encrypted (port 465 and 587) as well as unencrypted e-mails (port 25).

Examples of an application

E-mail receipt (POP3)

Short description:

Using the function POP3 it is possible to receive e-mails via the AK-XXL products with the help of the POP protocol. To do so, the interface picks up e-mails from the POP3 e-mail account and will send the contents to the serial interface. The output interface will be determined via the reference line. For the first interface "DEVICE=1" will be entered in the reference line. Different formats of incoming e-mails are allowed. Such formats are HTML, TEXT and ATTACHEMENT. In our example we are presenting it by means of an ATTACHMENT. In addition it is possible to define filters which shall avoid that e.g. SPAM or generally misrouted e-mails are output at the serial interface. To do so, the whole or a part of the sender address can be entered under "ONLY FROM". If you enter for instance @ak-nord.de all e-mails with the sender address of the ak-nord.de domain are admitted. In addition you can determine the name of the annex (ATTACHEMENT) and you can enter an additional word as filter beside the command "DEVICE=1".

Example:

A plug shall be switched on and off by e-mail. To do so, connect the switchable plug with the device server via RS232. It will pick up the e-mails from the POP3 inbox every 5 minutes. If the e-mail corresponds to the filter criteria, the contents of the annex will be output to the serial interface. In this case, it is the switch command of the plug.

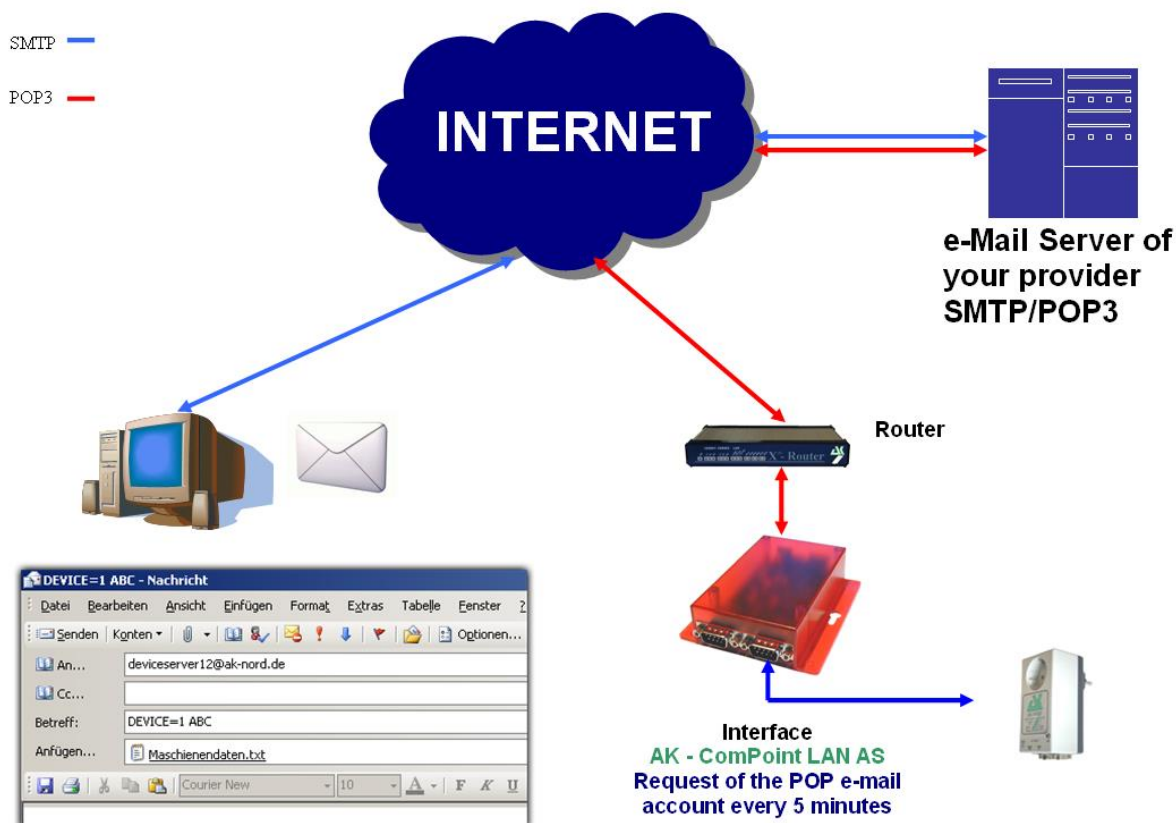

Examples of an application

Configuration:

Establish a connection to the interface via Telnet or browser. Then select the “NETWORK MENU” and then the “POP3 MENU”.



```
Telnet 192.168.100.100
===== POP3 MENU =====
1 = POP3 (Y/N)           = Y
2 = CHECK EMAIL         = 5 (min)
3 = POP3 SERVER         = pop-mail.t-online.de
4 = USER                = deviceserver12@ak-nord.de
5 = PASSWORD            = *****
6 = PORT                 = 110

7 = REPLY EMAIL (Y/N)  = Y
8 = ONLY FORMAT         = ATACHEMENT
9 = ONLY FROM           = @ak-nord.de
a = ONLY SUBJECT        = ABC
b = ONLY ATTACHMENT     = Maschinendaten.txt

Last State              = RUNNING
                        Last Mail
From                    =
To                      =
Subject                 =
Date                    =
Attachment              =
For example: '1=Y'

[Q = QUIT] Please enter your choice:
```

Process

As soon as you have entered the access data for your POP inbox and there is standing RUNNING after the item „Last State“ after having restarted the device server, send a correspondingly formatted e-mail to the entered inbox.

To: (e-mail address of the POP inbox) / Reference: DEVICE=1 ABC / Attachment: Maschinendaten.txt

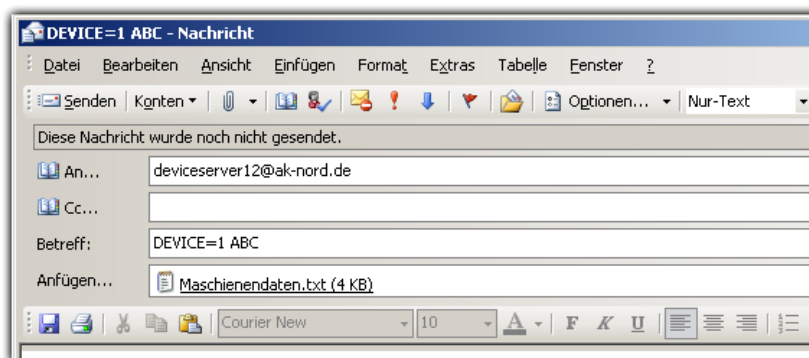

Note:

For a mail server outside of your network, the standard gateway and a DNS server are imperatively required in order to guarantee the communication. You will find setting options in the menu “IP“ and “DNS“ below the “NETWORK MENU“.

Examples of an application

Exporting a configuration

Short description:

Using the option “Create Config-File” in the ADMIN menu of the AK-XXL products, it is possible to save the current settings on the internal flashdrive and download them by FTP from the device server. All values are saved except from the IP address and the MAC address. The file has got the name “CONFIG.EEP”. If you want to load the configuration again, the file also needs to be uploaded on the internal Flashdrive with exactly the same name via FTP.

Example:

In order to save the configuration go to the ADMIN MENU. Then set the value 1=Y. After a short delay the following items will be displayed:

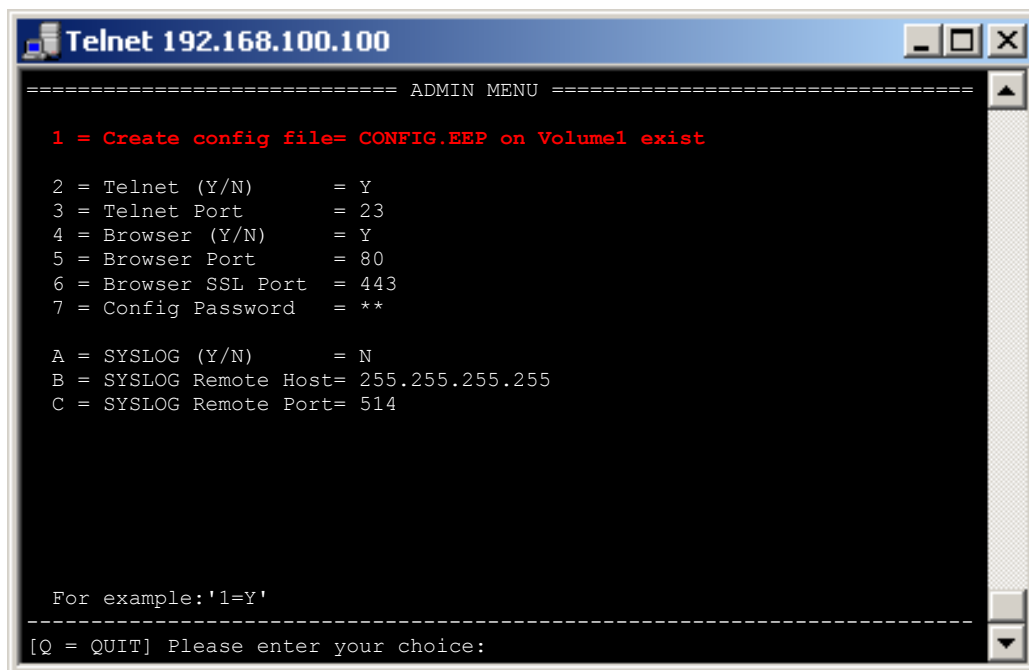

```
Telnet 192.168.100.100
===== ADMIN MENU =====
1 = Create config file= CONFIG.EEP on Volume1 exist
2 = Telnet (Y/N)           = Y
3 = Telnet Port           = 23
4 = Browser (Y/N)        = Y
5 = Browser Port         = 80
6 = Browser SSL Port     = 443
7 = Config Password     = **

A = SYSLOG (Y/N)         = N
B = SYSLOG Remote Host= 255.255.255.255
C = SYSLOG Remote Port= 514

For example: '1=Y'
-----
[Q = QUIT] Please enter your choice:
```

The configuration is now located on the FTP server in the folder “Volume1”.

Examples of an application

Then use an FTP program or a browser in order to connect to the internal FTP server of the AK-XXL product.

Use "ak" as user name. However the name will not be evaluated. The standard password is "xt".

After having successfully logged in, it is possible to download the file and to save it on your PC.

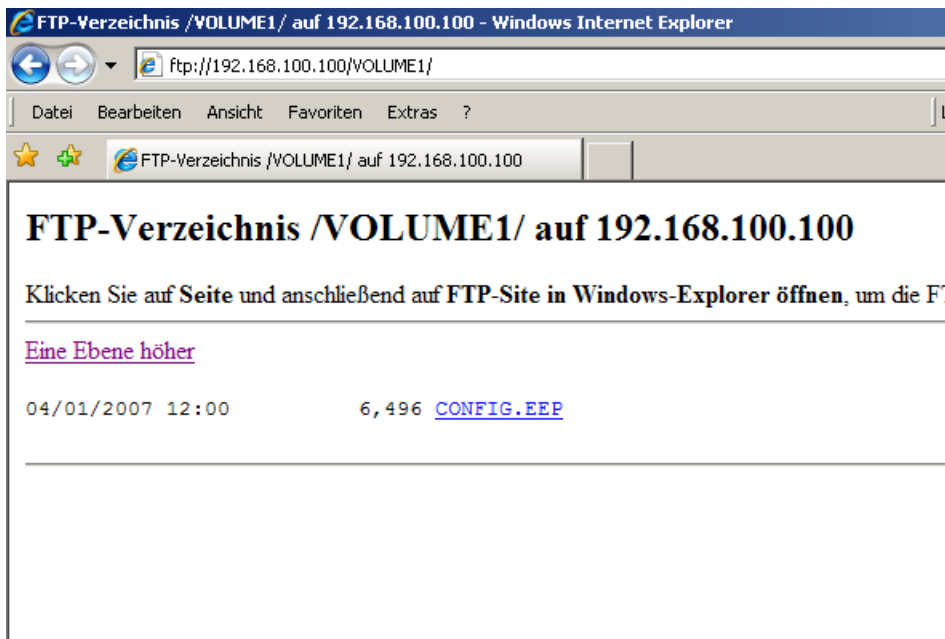

Examples of an application

Importing a configuration

Short description:

Using the option “Create Config-File“ in the ADMIN menu of the AK-XXL products, it is possible to save the current settings on the internal flashdrive and download them by FTP from the device server. All values are saved except from the IP address and the MAC address. The file has got the name “CONFIG.EEP“. If you want to load the configuration again, the file also needs to be uploaded on the internal Flashdrive with exactly the same name via FTP.

Example:

In order to “install“ an already saved configuration on a device, the configuration file needs to be transmitted to the folder Volume1 on the device server via FTP. The file needs to have the name “CONFIG.EEP“. In order to transfer the file, you can either use the Windows-Explorer (not Internet Explorer) or an FTP program. Connect to the internal FTP server of the AK-XXL product and log in with the user “ak“ and the password “xt“ (it is also possible to change the password under NETWORK MENU→FTP MENU). Then open the folder “Volume1“ and transfer the file “CONFIG.EEP“.

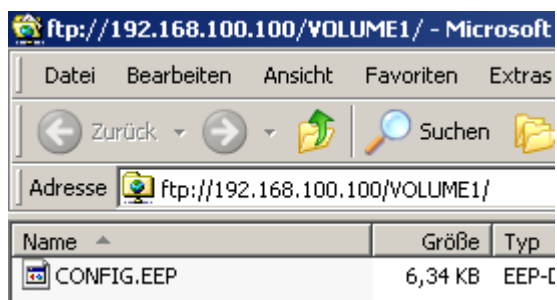

When you have successfully transferred the file, start the device server by entering the letter “r“ in the “MAIN MENU“ and confirm by pressing the RETURN/ENTER key.

When the configuration had been successfully taken over, it will automatically be deleted. You can check this by looking into the folder “Volume1“ via FTP. If the files “CONFIG.EEP“ are no longer available they had been successfully taken over.

You can also check the value können Sie im “Create config file“ in the “ADMIN MENU“. If an “N“ is entered, the file had been taken over. However, if “CONFIG.EEP on Volume1 exist“ is entered, the configuration file had not yet been taken over.

Examples for applications

DYNDNS

If you want to access from a central company network to a remote connected device server or print server via the Internet, you generally need a static costly IP address assigned by the ISP. DynDNS offers you the option to be available in spite of changing IP addresses and to access the products of the company **AK-NORD**. The company network or the remote router (refer to illustr.1 Router 2) will not be identified by means of the IP address, but by means of a DNS name.

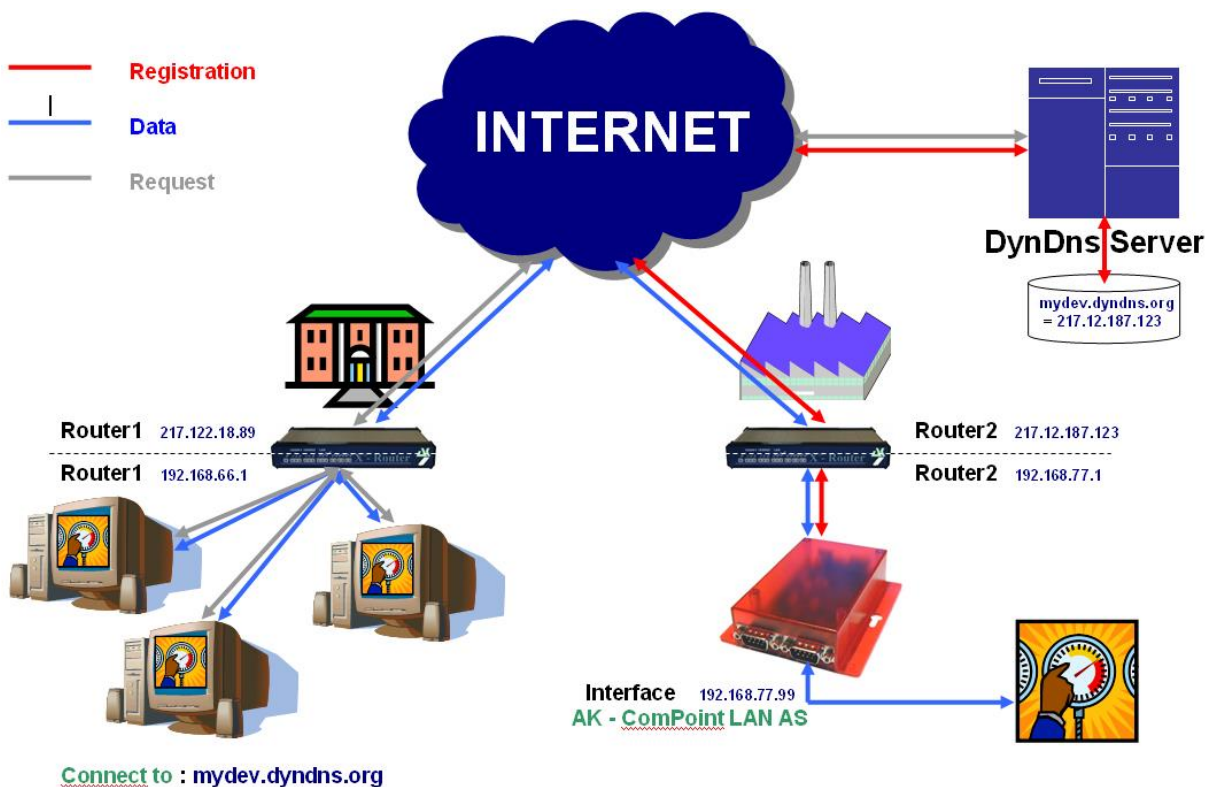

On principle the process is quite easy. The **AK-ComPoint-LAN-AS** checks the availability of the DYNDNS server in regular intervals. Upon the request "CheckIP", the IP address of the **Router2** will be responded by the DYNDNS-Server. If it deviates, e.g. due to a forced disconnection from the ISP from the IP address which had been saved in the interface, the new IP address will be registered completely automatically in the DYNDNS server (refer to "**Registration** -----"). The registration takes place in the account which you have created at DYNDNS. It is only required to **release** the IP address and/or the TCP/IP port in the **Router2** (Port Forwarding). In order to address the **AK-ComPoint-LAN-AS**, just connect via "mydev.dyndns.org". This request (see "Request -----") will be resolved by **Router1** and you can directly start the data transfer (see "Data -----").

Examples for applications

XT-NANO-XXL, COMPOINT-XXL, ComPoint-LAN -XXL

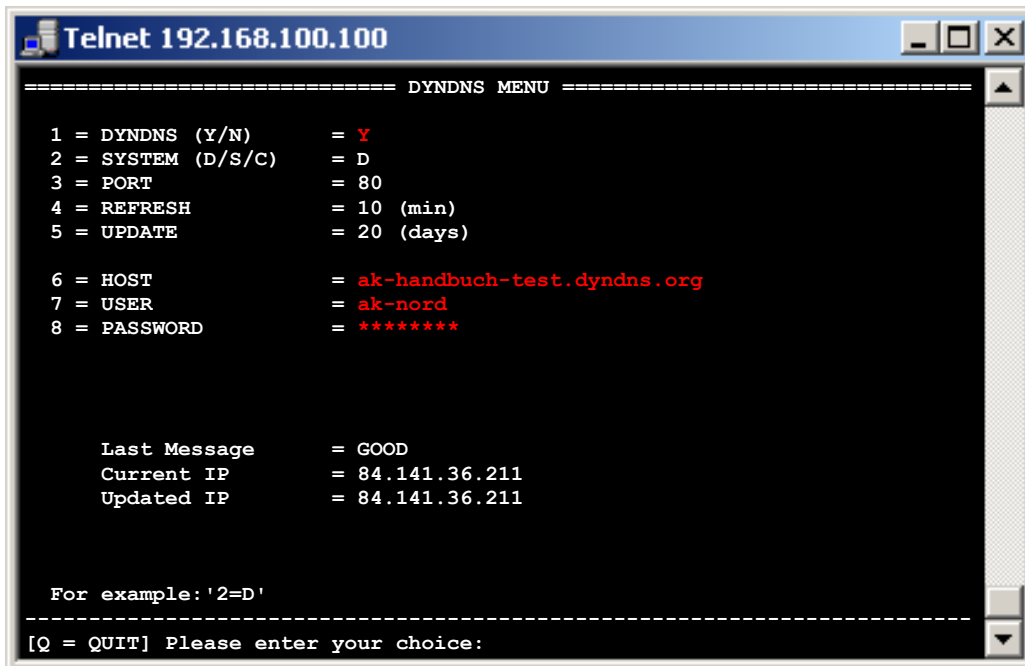

```
Telnet 192.168.100.100
===== DYNDNS MENU =====
1 = DYNDNS (Y/N)           = Y
2 = SYSTEM (D/S/C)        = D
3 = PORT                   = 80
4 = REFRESH                = 10 (min)
5 = UPDATE                 = 20 (days)

6 = HOST                   = ak-handbuch-test.dyndns.org
7 = USER                  = ak-nord
8 = PASSWORD               = *****

Last Message              = GOOD
Current IP                 = 84.141.36.211
Updated IP                 = 84.141.36.211

For example: '2=D'
-----
[Q = QUIT] Please enter your choice:
```

Connect to the interface via Telnet.



Note:

Please the menu "DYNDNS" in the "NETWORK MENU".

Examples of applications

Please find following the setting options:

- | | |
|--------------------------|---|
| 1 = DYNDNS Y/N | With this option you can determine via “ Y ” = Yes or “ N ” = No, if this function is activated or not. |
| 2 = SYSTEM D/S/C | Using this option you can select the type of procedure.
D = Dynamic
S = Static
C = Custom |
| 3 = PORT | Using this option, you can determine the target port of the requests or of the registration. Either port 80 = Webserver or 8245 to bypass the proxy server. |
| 4 = REFRESH * min | Using this option you determine at which intervals the IP address is being checked. |
| 5 = UPDATE * days | Using this option you determine at what point in time the new registration of the IP address will take place on the DYNDNS server at the latest. The input only applies if your IP address does not change within the determined period of time. DYNDNS prescribes a registration after latest 27 days. Otherwise, the name resolution e.g. mydev.dyndns.org will no longer be responded. |
| 6 = HOST | Includes your account data which you use to log in |
| 7 = USER | DYNDNS |
| 8 = PASSWORD | |
| Last Message | current status |
| Current IP | current IP address e.g. of the Router1 |
| Updated IP | saved IP address |



Note:

If several AK-Nord interfaces are available, please activate the DYNDNS procedure only for one interface. The availability of the different interfaces are available via the PORT – FORWARDING in your router or in your firewall.

Examples of an application

Last Message

NOMSG	Inquiry had not been replied
NOCHG	Update of the IP address at DYNDNS had been successful but same.
GOOD	Update of the IP address at DYNDNS had been successful
NODNSSRV	No DNS server is stored in the interface. (DHCP)
NOGW	No GW is entered in the interface (DHCP)
ENTRYERR	The input HOST,USER or PASSWORD
NOTINUSE	The procedure is not active.

The following error messages are created by the DYNDNS server.

DNSERR

ABUSE

!YOURS

NOHOST

NOTFQDN

BADAUTH

BADSYS

BADAGENT

You can look them up directly at:

<http://www.dyndns.com/developers/specs/return.html>



Note:

*If the message **DNSERR**, **ABUSE**, **!YOURS**, **NOHOST**, **NOTFQDN**, **BADAUTH**, **BADSYS** or **BADAGENT** are entered, the DYNDNS procedure is stopped and requires a manual restart of the interface.*

Creating a homepage

From **version 1.6.3** on you can create your own homepage on the AK-Nord interfaces.

XXL series:

It is necessary to connect an additional memory, since the internal FlashFileSystem of the XXL series only has 15KB. To do so, connect a flash component or an SD card.

ComPoint-LAN-XXL:

SD card holder is internally available.

ComPoint-WLAN-XXR:

Sufficient memory available

XT-NANO-XXL and XT-PICO-XXL:

It is possible to connect an additional flash component or an SD card on Bus1 or Bus2.

SXL series:

The internal FlashFileSystem of the SXL series is equipped with a 512KB memory and can thus be used without any additional memory.

Request the prepared homepage project from AK-NORD. Please find a description of the way of proceeding in the project.

Warranty

Warranty

The information in this manual might change without prior notice. In spite of elaborateness this manual might include errors or be incomplete. We do not take any liability for errors or data losses as a result hereof.