

Cable connector - CA-16S1N12T008 - 1620182

Please be informed that the data shown in this PDF Document is generated from our Online Catalog. Please find the complete data in the user's documentation. Our General Terms of Use for Downloads are valid (<http://phoenixcontact.com/download>)

Cable connector, angled, shielded: yes, Screw locking, M23, No. of pos.: 16, type of contact: Socket, Solder connection, cable diameter range: 10 mm ... 14.5 mm



The figure shows the 12-pos. product version

Why buy this product

- Angled cable outlet for confined spaces
- Can be adapted to various applications, thanks to adjustable cable outlet direction
- Safe use in the field, thanks to high degree of protection
- Connector for flexible on-site assembly
- Consistent EMC protection for reliable transmission of signals
- Solder connection: proven connection technology for various litz wires

Key Commercial Data

Packing unit	1 STK
GTIN	
GTIN	4046356818636

Technical data

Temperature range

Ambient temperature (operation)	-40 °C ... 125 °C
---------------------------------	-------------------

Data of the insulating body

Coding	N
Insulator material	PBT
Contact material	CuZn
Contact surface material	Ni/Au
Contact connection method	Solder connection
Type of contacts	Socket
Application	Signal

Cable connector - CA-16S1N12T008 - 1620182

Technical data

Data of the insulating body

Number of positions	16
Contact diameter of power contacts	1 mm
Litz wire cross section of power contacts min.	0.08 mm ²
Litz wire cross section of power contacts max.	1 mm ²
Nominal current per power contact at 25°C	8 A
Nominal voltage, power contact	150 V
Rated surge voltage	1.5 kV
Overvoltage category	II
Degree of pollution	3

Housing data

Housing material	Turned parts: copper zinc alloy (CuZn), die-cast parts: zinc (GD-Zn)
Type of locking	Screw locking
Degree of protection (when plugged in)	IP67
Thread type	M23

Cable seal data

Cable diameter	10 mm ... 14.5 mm
Sealing material	NBR

Environmental Product Compliance

REACH SVHC	Lead 7439-92-1
China RoHS	Environmentally Friendly Use Period = 50
	For details about hazardous substances go to tab "Downloads", Category "Manufacturer's declaration"

Drawings

Schematic diagram

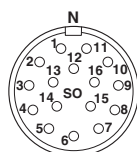

Dimensional drawing

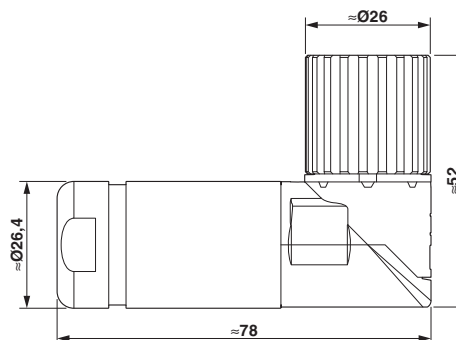

Approvals

Approvals

Cable connector - CA-16S1N12T008 - 1620182

Approvals

Approvals

UL Recognized / cUL Recognized / cULus Recognized

Ex Approvals

Approval details

UL Recognized		http://database.ul.com/cgi-bin/XYV/template/LISEXT/1FRAME/index.htm E335019-20141210
Nominal voltage UN		150 V
Nominal current IN		8 A
mm ² /AWG/kcmil		18

cUL Recognized		http://database.ul.com/cgi-bin/XYV/template/LISEXT/1FRAME/index.htm E335019-20141210
Nominal voltage UN		150 V
Nominal current IN		5 A
mm ² /AWG/kcmil		18

cULus Recognized		
------------------	--	--

Phoenix Contact 2018 © - all rights reserved
<http://www.phoenixcontact.com>

PHOENIX CONTACT GmbH & Co. KG
Flachsmarktstr. 8
32825 Blomberg
Germany
Tel. +49 5235 300
Fax +49 5235 3 41200
<http://www.phoenixcontact.com>