

SMA 50 Ohm - Reverse Thread Right Angle Crimp Type Plug - Captivated Contact Low Loss Cable

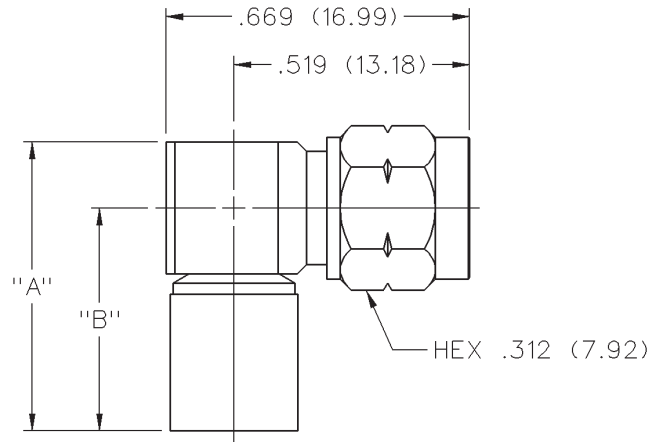

INCHES (MILLIMETERS)
CUSTOMER DRAWINGS AVAILABLE UPON REQUEST



CABLE TYPE	VSWR & FREQ. RANGE	GOLD PLATED	NICKEL PLATED	"A"	"B"
LMR-240, HPF-240, RF-240	1.10 + .06f (GHz) 0-12.4 GHz	142-5435-101	142-5435-106	.635 (16.13)	.490 (12.45)

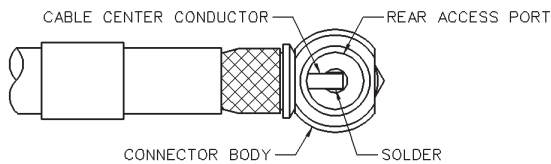
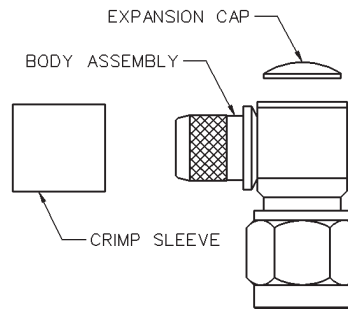
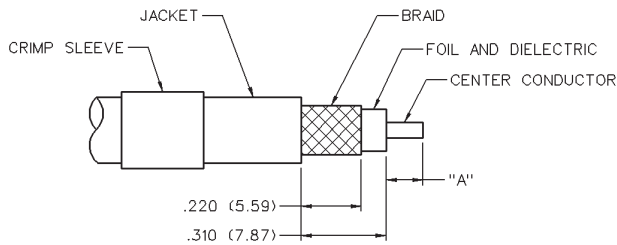

CABLE GROUP	PART NUMBER	CRIMP HEX
LMR-240	142-5435-101	.240 (6.10)
	142-5435-106	.240 (6.10)

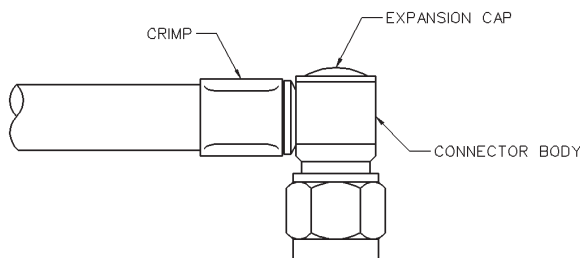

1. Identify connector parts. (3 piece parts)
2. Strip cable to dimensions shown. Do not nick braid, foil or center conductor. Cut foil flush with dielectric, do not remove foil. Make sure that dielectric is clean and free from all particles. Tin center conductor, keeping solder amount to a minimum. Slide crimp sleeve onto jacket of cable.
3. Flare braid and slide body assembly over foil and dielectric, then under braid. Make sure cable center conductor is contained within connector contact, but do not allow foil and dielectric to enter body access port. Solder center conductor to contact through the rear access port. Use a minimum amount of solder for a full fillet joint. .020 (0.51) Diameter solder is recommended.
4. Arrange braid uniformly around crimp stem. Slide crimp sleeve forward and crimp using Johnson Components™ hand crimp tool 141-0000-913 and recommended crimp die hex. Place expansion cap in access port and seat with recommended Diameter flat punch.

SMA Reverse Thread - 50 Ohm



Specifications

INCHES (MILLIMETERS)
CUSTOMER DRAWINGS AVAILABLE UPON REQUEST

ELECTRICAL RATINGS

Impedance: 50 ohms

Frequency Range:

Flexible cable connectors 0-12.4 GHz
Uncabled receptacles 0-18.0 GHz

VSWR: (f = GHz)

	Straight Cabled Connectors	Right Angle Cabled Connectors
RG-316, LMR-100 cable	1.15 + .02f	1.15 + .03f
RG-58, LMR-195 cable	1.15 + .01f	1.15 + .02f
RG-142 cable	1.15 + .01f	1.15 + .02f
LMR-200, LMR-240 cable	1.10 + .03f	1.10 + .06f

Uncabled receptacles N/A

Working Voltage: (Vrms maximum)†

Connectors for Cable Type	Sea Level	70K Feet
RG-316; LMR-100, 195, 200	250	65
RG-58, RG-142, LMR-240, uncabled receptacles	335	8

Dielectric Withstanding Voltage: (VRMS minimum at sea level)†

Connectors for RG-316; LMR-100, 195, 200 750
Connectors for RG-58, RG-142, LMR-240, uncabled receptacles .. 1000

Corona Level: (Volts minimum at 70,000 feet)†

Connectors for RG-316, LMR-100, 195, 200 190
Connectors for RG-58, RG-142, LMR-240, uncabled receptacles ... 250

Insertion Loss: (dB maximum)

Straight flexible cable connectors06	√ f (GHz), tested at 6 GHz
Right angle flexible cable connectors	0.15	√ f (GHz), tested at 6 GHz
Low loss flexible straight cable connectors	0.06	√ f (GHz), tested at 1 GHz
Low loss flexible right angle cable connectors	0.15	√ f (GHz), tested at 1 GHz
Uncabled receptacles, field replaceable	N/A	

Insulation Resistance: 5000 megohms minimum

Contact Resistance: (milliohms maximum)

	Initial	After Environmental
Center contact (straight cabled connectors and uncabled receptacles)	3.0*	4.0*
Center contact (right angle cabled connectors)	4.0	6.0
Outer contact (all connectors)	2.0	N/A
Braid to body (gold plated connectors)	0.5	N/A
Braid to body (nickel plated connectors)	5.0	N/A

RF Leakage: (dB minimum, tested at 2.5 GHz)

Flexible cable connectors -60 dB
Uncabled receptacles and adapters N/A

RF High Potential Withstanding Voltage: (Vrms minimum, tested at 4 and 7 MHz)†

Connectors for RG-316; LMR-100, 195, 200 500
Connectors for RG-58, RG-142, LMR-240, uncabled receptacles ... 670

MECHANICAL RATINGS

Engagement Design: MIL-C-39012, Series SMA

Engagement/Disengagement Force: 2 inch-pounds maximum

Mating Torque: 7 to 10 inch-pounds

Bulkhead Mounting Nut Torque: 15 inch-pounds

Coupling Proof Torque: 15 inch-pounds minimum

Coupling Nut Retention: 60 pounds minimum

Contact Retention:

6 lbs. minimum axial force (captivated contacts)
4 inch-ounce minimum torque (uncabled receptacles)

Cable Retention:	Axial Force* (pounds)	Torque (in-oz)
Connectors for RG-316, LMR-100	20	N/A
Connectors for LMR-195, 200	30	N/A
Connectors for RG-58; LMR-240	40	N/A
Connectors for RG-142	45	N/A

*Or cable breaking strength whichever is less.

Durability: 500 cycles minimum

ENVIRONMENTAL RATINGS (Meets or exceed the applicable paragraph of MIL-C-39012)

Temperature Range: - 65°C to + 165°C

Thermal Shock: MIL-STD-202, Method 107, Condition B

Corrosion: MIL-STD-202, Method 101, Condition B

Shock: MIL-STD-202, Method 213, Condition I

Vibration: MIL-STD-202, Method 204, Condition D

Moisture Resistance: MIL-STD-202, Method 106

MATERIAL SPECIFICATIONS

Bodies: Brass per QQ-B-626, gold plated* per MIL-G-45204 .00001" min. or nickel plated per QQ-N-290

Contacts: Male - brass per QQ-B-626, gold plated per MIL-G-45204 .00003" min.

Female - beryllium copper per QQ-C-530, gold plated per MIL-G-45204 .00003" min.

Nut Retention Spring: Beryllium copper per QQ-C-533. Unplated

Insulators: PTFE fluorocarbon per ASTM D 1710 and ASTM D 1457 or Tefzel per ASTM D 3159

Expansion Caps: Brass per QQ-B-613, gold plated per MIL-G-45204 .00001" min. or nickel plated per QQ-N-290

Crimp Sleeves: Copper per WW-T-799 or brass per QQ-B-613, gold plated per MIL-G-45204 .00001" min. or nickel plated per QQ-N-290

Mounting Hardware: Brass per QQ-B-626 or QQ-B-613, gold plated per MIL-G-45204 .00001" min. or nickel plated per QQ-N-290

Mating Engagement for SMA Reverse Thread Series per FCC Rule 15 Non-Standard Interface

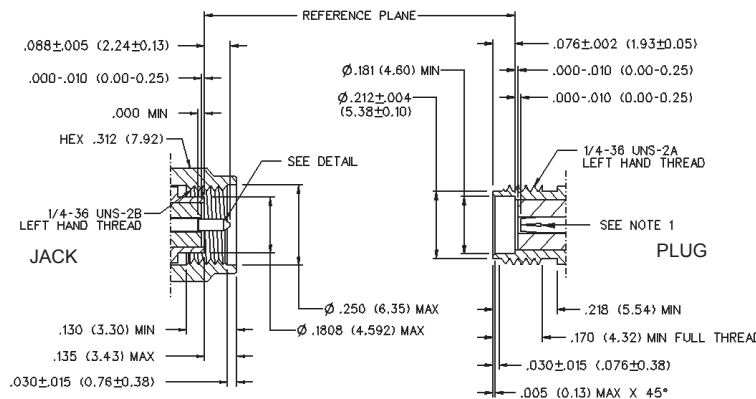

NOTES

1. ID OF CONTACT TO MEET VSWR, CONTACT RESISTANCE AND INSERTION WITHDRAWAL FORCES WHEN MATED WITH DIA .0355-.0370 .0355-.0370 MALE PIN.

†Avoid user injury due to misapplication. See safety advisory definitions inside front cover.

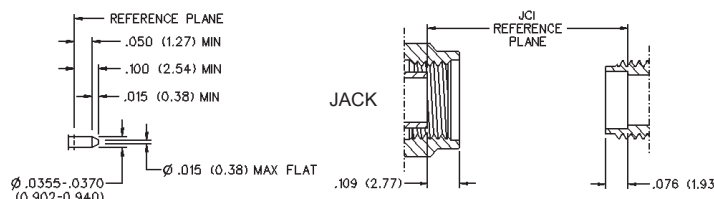

Cinch Connectivity Solutions

299 Johnson Avenue SW, Waseca, MN 56093 USA • 800.247.8256 • +1 507 833 8822 • cinchconnectivity.com