

UNCONTROLLED DOCUMENT

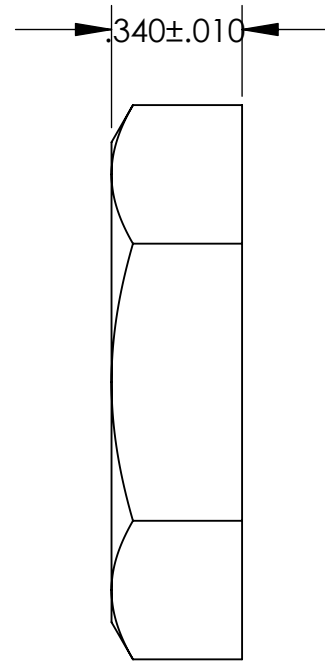
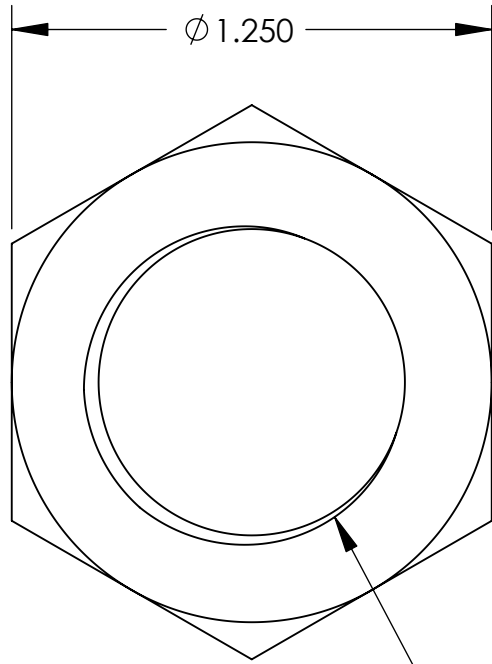

7/8"-14 THREADS

TOLERANCES UNLESS NOTED

- ±.005 ON DIMENSIONS THRU .625
- ±.008 ON DIMENSIONS .626 THRU 1.000
- ±.010 ON DIMENSIONS 1.001 THRU 1.500
- ±.015 ON DIMENSIONS LARGER THAN 1.500
- ±.015 ON FRACTIONAL DIMENSIONS

WE RESERVE THE RIGHT TO DISCONTINUE ITEMS, CHANGE SPECIFICATIONS OR DESIGN AT ANY TIME WITHOUT NOTICE AND WITHOUT INCURRING ANY OBLIGATIONS

PROPERTY OF		
MICRO PLASTICS INC.		
CATALOG DRAWING NYLON HEX JAM NUTS MICRO P/N 0487514HJN DWG. # 0487514HJN FILE SERVER\ENG\WEB		
MATERIAL:		NYLON 6/6
DATE	SCALE	SD
	2:1	