

WIDE BAND SP4T SWITCH

DESCRIPTION

The μ PD5731T6M is a CMOS MMIC SP4T switch which was developed for mobile communications, wireless communications and another RF switching applications.

<R> This device can operate frequency from 0.01 to 2.0 GHz, having the low insertion loss and high isolation.

This device is housed in a 12-pin plastic TSQFN (Thin Small Quad Flat Non-leaded) (T6M) package. And this package is able to high-density surface mounting.

FEATURES

- Supply voltage : $V_{DD} = 1.5$ to 3.6 V (2.8 V TYP.)
- Switch control voltage : $V_{cont(H)} = 1.5$ to 3.6 V (2.8 V TYP.)
: $V_{cont(L)} = -0.2$ to $+0.4$ V (0 V TYP.)
- Low insertion loss : $L_{ins1} = 0.7$ dB TYP. @ $f = 0.01$ to 0.05 GHz, $V_{DD} = 2.8$ V, $V_{cont(H)} = 2.8$ V, $V_{cont(L)} = 0$ V
: $L_{ins2} = 1.0$ dB TYP. @ $f = 0.05$ to 1.0 GHz, $V_{DD} = 2.8$ V, $V_{cont(H)} = 2.8$ V, $V_{cont(L)} = 0$ V
: $L_{ins3} = 1.4$ dB TYP. @ $f = 1.0$ to 2.0 GHz, $V_{DD} = 2.8$ V, $V_{cont(H)} = 2.8$ V, $V_{cont(L)} = 0$ V
- High isolation : $ISL1 = 60$ dB TYP. @ $f = 0.01$ to 0.05 GHz, $V_{DD} = 2.8$ V, $V_{cont(H)} = 2.8$ V, $V_{cont(L)} = 0$ V
: $ISL2 = 35$ dB TYP. @ $f = 0.05$ to 1.0 GHz, $V_{DD} = 2.8$ V, $V_{cont(H)} = 2.8$ V, $V_{cont(L)} = 0$ V
: $ISL3 = 26$ dB TYP. @ $f = 1.0$ to 2.0 GHz, $V_{DD} = 2.8$ V, $V_{cont(H)} = 2.8$ V, $V_{cont(L)} = 0$ V
- Handling power : $P_{in(1\text{ dB})} = +20$ dBm TYP. @ $f = 1.0$ GHz, $V_{DD} = 2.8$ V, $V_{cont(H)} = 2.8$ V, $V_{cont(L)} = 0$ V
: $P_{in(0.1\text{ dB})} = +17$ dBm TYP. @ $f = 1.0$ GHz, $V_{DD} = 2.8$ V, $V_{cont(H)} = 2.8$ V, $V_{cont(L)} = 0$ V
- High-density surface mounting : 12-pin plastic TSQFN (T6M) package ($2.0 \times 2.0 \times 0.37$ mm)

APPLICATIONS

- Mobile communications
- Wireless communications
- Another RF switching applications

ORDERING INFORMATION

Part Number	Order Number	Package	Marking	Supplying Form
μ PD5731T6M-E2	μ PD5731T6M-E2-A	12-pin plastic TSQFN (T6M) (Pb-Free)	5731	<ul style="list-style-type: none"> • Embossed tape 8 mm wide • Pin 10, 11, 12 face the perforation side of the tape • Qty 3 kpcs/reel

Remark To order evaluation samples, contact your nearby sales office.

Part number for sample order: μ PD5731T6M-A

Caution: Observe precautions when handling because these devices are sensitive to electrostatic discharge

The information in this document is subject to change without notice. Before using this document, please confirm that this is the latest version.

PIN CONNECTIONS AND INTERNAL BLOCK DIAGRAM

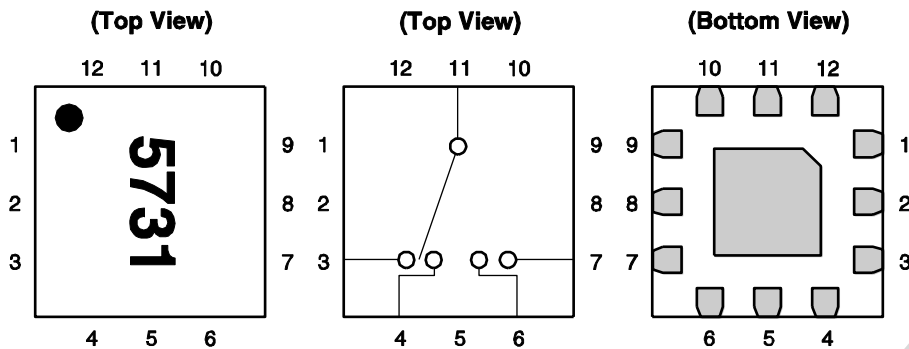

Pin No.	Pin Name
1	NC
2	GND
3	OUTPUT1
4	OUTPUT2
5	GND
6	OUTPUT3
7	OUTPUT4
8	GND
9	V _{cont1}
10	V _{cont2}
11	INPUT
12	V _{DD}

TRUTH TABLE

ON-state	V _{cont1}	V _{cont2}
INPUT-OUTPUT1	Low	Low
INPUT-OUTPUT2	Low	High
INPUT-OUTPUT3	High	Low
INPUT-OUTPUT4	High	High

Remark High: +2.8 V, Low: 0 V

ABSOLUTE MAXIMUM RATINGS (T_A = +25°C, unless otherwise specified)

Parameter	Symbol	Ratings	Unit
Supply Voltage	V _{DD}	-0.5 to +4.6	V
Switch Control Voltage	V _{cont}	-0.5 to +4.6	V
Voltage Difference	V _{cont (H)} - V _{DD}	+0.5	V
Input Power	P _{in}	+23	dBm
Operating Ambient Temperature	T _A	-45 to +85	°C
Storage Temperature	T _{stg}	-55 to +150	°C

RECOMMENDED OPERATING RANGE (T_A = +25°C, unless otherwise specified)

Parameter	Symbol	MIN.	TYP.	MAX.	Unit
Supply Voltage	V _{DD}	+1.5	+2.8	+3.6	V
Switch Control Voltage (H)	V _{cont (H)}	+1.5	+2.8	+3.6	V
Switch Control Voltage (L)	V _{cont (L)}	-0.2	0	+0.4	V

Remark V_{DD} - 0.4 V ≤ V_{cont (H)} ≤ V_{DD} + 0.2 V

ELECTRICAL CHARACTERISTICS

($T_A = +25^\circ\text{C}$, $V_{DD} = 2.8\text{ V}$, $V_{\text{cont(H)}} = 2.8\text{ V}$, $V_{\text{cont(L)}} = 0\text{ V}$, $P_{\text{in}} = 0\text{ dBm}$, DC cut capacitors = 10 000 pF, unless otherwise specified)

Parameter	Symbol	Test Conditions	MIN.	TYP.	MAX.	Unit
Insertion Loss 1	L_{ins1}	$f = 0.01\text{ to }0.05\text{ GHz}$	–	0.7	1.1	dB
Insertion Loss 2	L_{ins2}	$f = 0.05\text{ to }1.0\text{ GHz}$	–	1.0	1.4	dB
Insertion Loss 3	L_{ins3}	$f = 1.0\text{ to }2.0\text{ GHz}$	–	1.4	1.8	dB
Isolation 1	$ISL1$	$f = 0.01\text{ to }0.05\text{ GHz}$	50	60	–	dB
Isolation 2	$ISL2$	$f = 0.05\text{ to }1.0\text{ GHz}$	31	35	–	dB
Isolation 3	$ISL3$	$f = 1.0\text{ to }2.0\text{ GHz}$	23	26	–	dB
Input Return Loss 1	RL_{in1}	$f = 0.01\text{ to }1.0\text{ GHz}$	12	15	–	dB
Input Return Loss 2	RL_{in2}	$f = 1.0\text{ to }2.0\text{ GHz}$	10	12	–	dB
Output Return Loss 1	RL_{out1}	$f = 0.01\text{ to }1.0\text{ GHz}$	12	16	–	dB
Output Return Loss 2	RL_{out2}	$f = 1.0\text{ to }2.0\text{ GHz}$	10	14	–	dB
0.1 dB Loss Compression Input Power ^{Note 1}	$P_{\text{in}(0.1\text{ dB})}$	$f = 1.0\text{ GHz}$	+13	+17	–	dBm
1 dB Loss Compression Input Power ^{Note 2}	$P_{\text{in}(1\text{ dB})}$	$f = 1.0\text{ GHz}$	–	+20	–	dBm
Supply Current	I_{DD}	$V_{DD} = V_{\text{cont}} = 2.8\text{ V}$, RF off	–	0.01	1.0	μA
Switch Control Current	I_{cont}	$V_{DD} = V_{\text{cont}} = 2.8\text{ V}$, RF off	–	0.01	1.0	μA
Switch Control Speed	t_{sw}	$f = 1.0\text{ GHz}$	–	30	100	ns

Notes 1. $P_{\text{in}(0.1\text{ dB})}$ is measured the input power level when the insertion loss increases more 0.1 dB than that of linear range.

2. $P_{\text{in}(1\text{ dB})}$ is measured the input power level when the insertion loss increases more 1 dB than that of linear range.

Caution This device is used it is necessary to use DC cut capacitors.

The value of DC cut capacitors should be chosen to accommodate the frequency of operation, bandwidth, switching speed and the condition with actual board of your system.

EVALUATION CIRCUIT

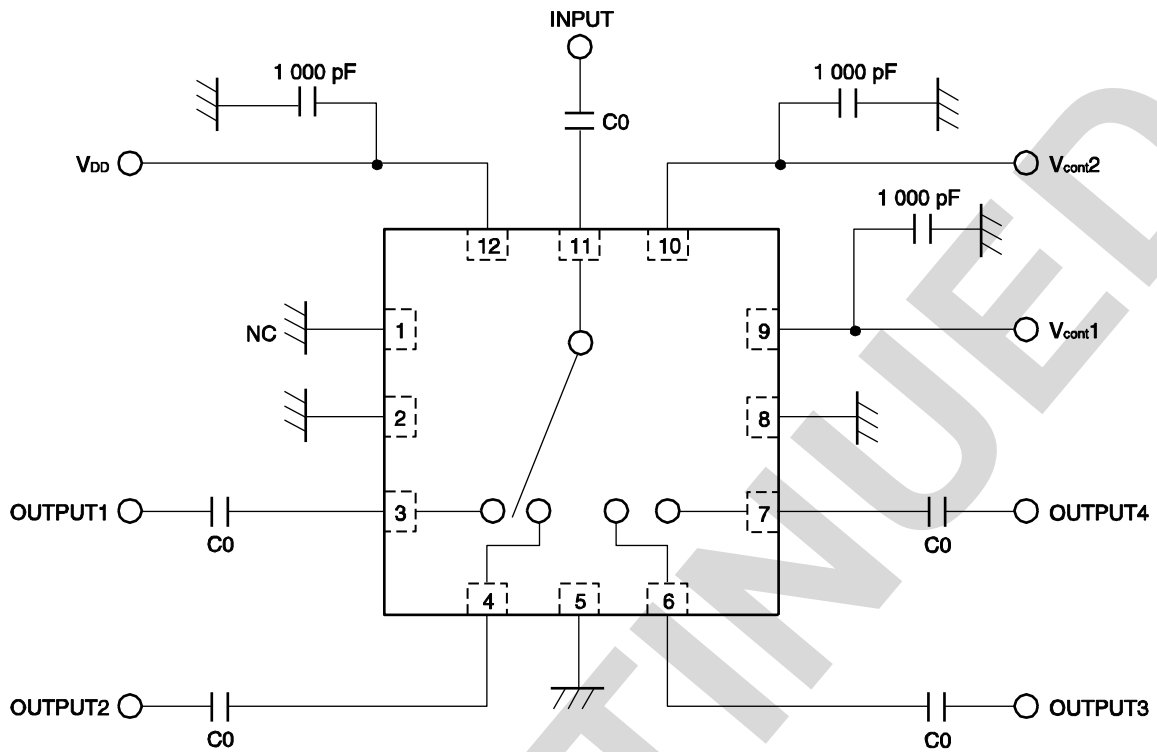

Remark C0 = 10 000 pF

Caution This IC has pull down resistance between RF line and GND, which fixes electric potential of RF line to 0 V, then the IC cannot be used for DC switching.

The application circuits and their parameters are for reference only and are not intended for use in actual design-ins.

<R> ILLUSTRATION OF THE TEST CIRCUIT ASSEMBLED ON EVALUATION BOARD

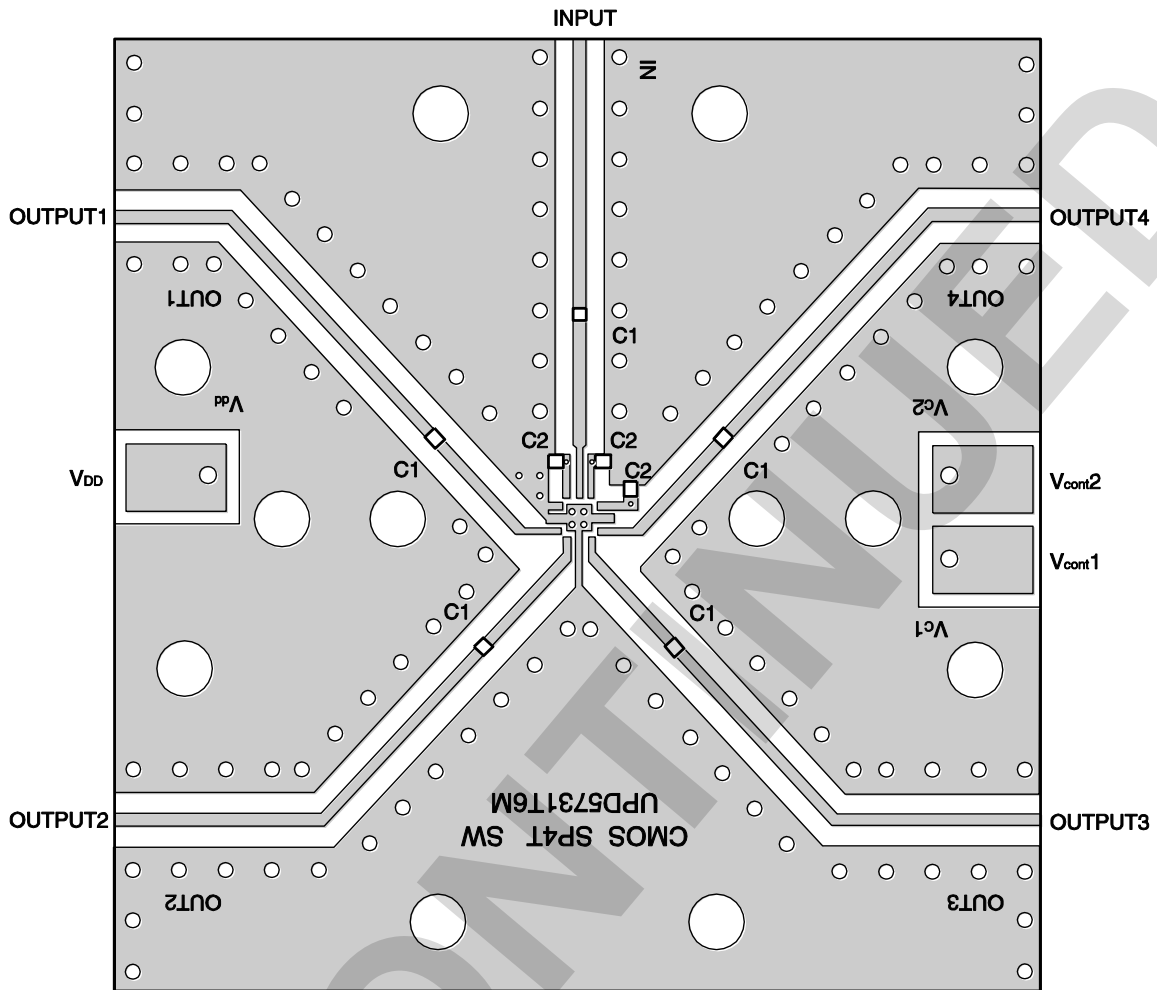

<R> USING THE EVALUATION BOARD

Symbol	Values
C2	1 000 pF
C1	10 000 pF

<R> **TYPICAL CHARACTERISTICS**
 (T_A = +25°C, V_{DD} = 2.8 V, V_{cont (H)} = 2.8 V, V_{cont (L)} = 0 V, P_{in} = 0 dBm, DC cut capacitors = 10 000 pF, unless otherwise specified)

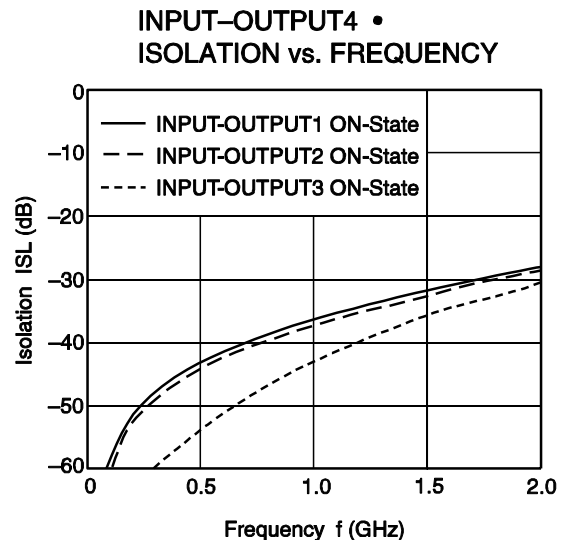
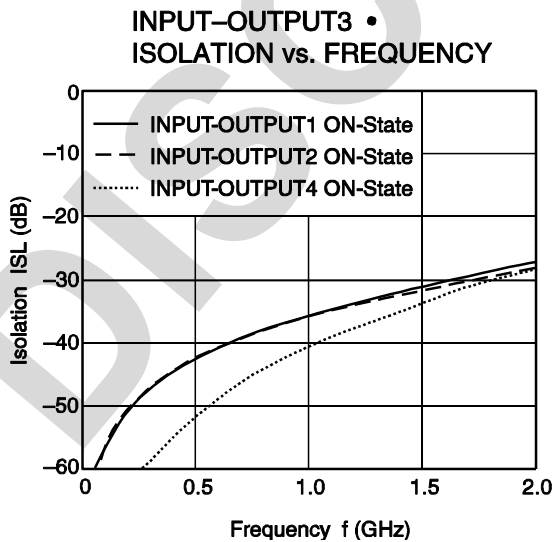
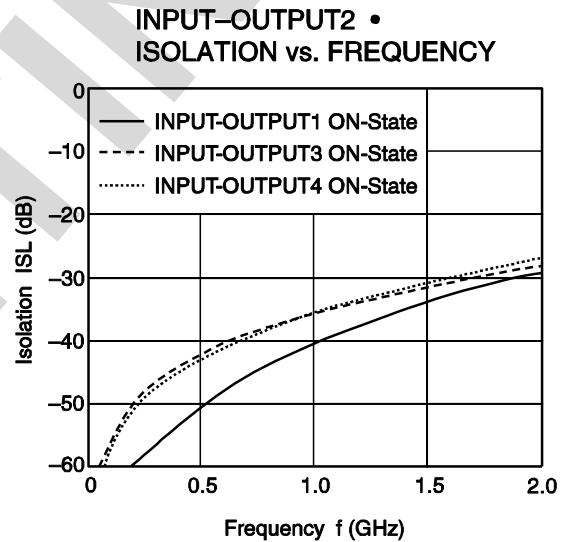
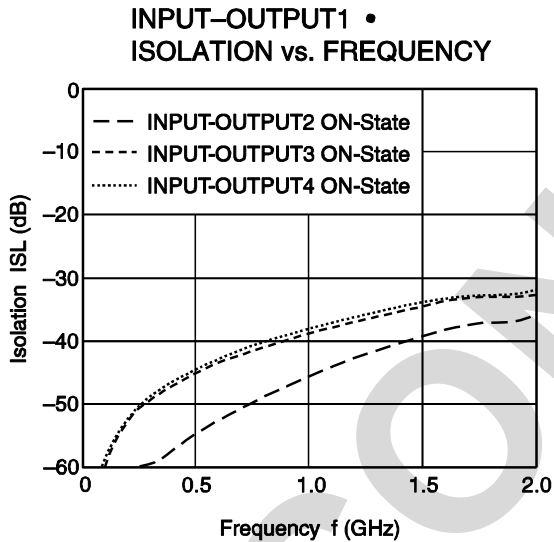
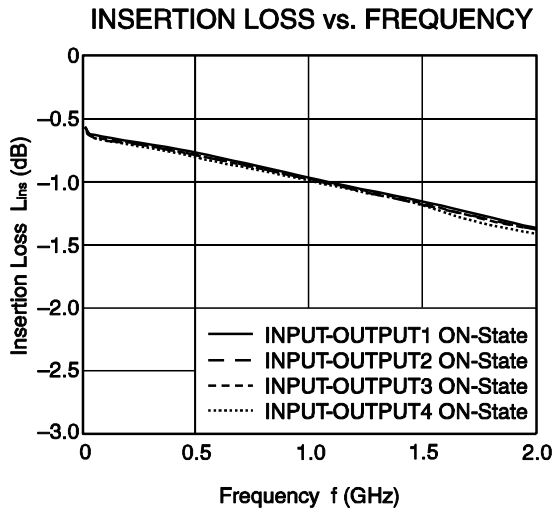

Remark The graphs indicate nominal characteristics.

INPUT RETURN LOSS vs. FREQUENCY

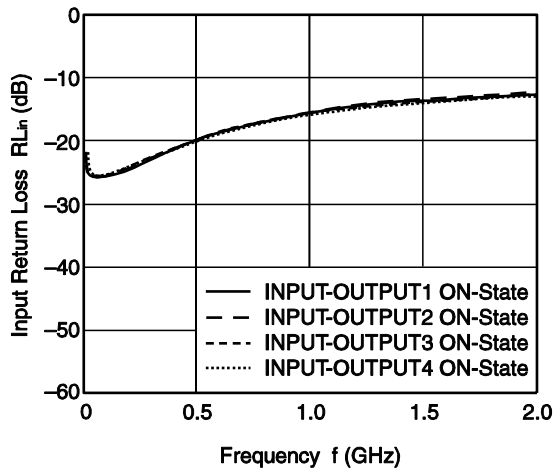

OUTPUT RETURN LOSS vs. FREQUENCY

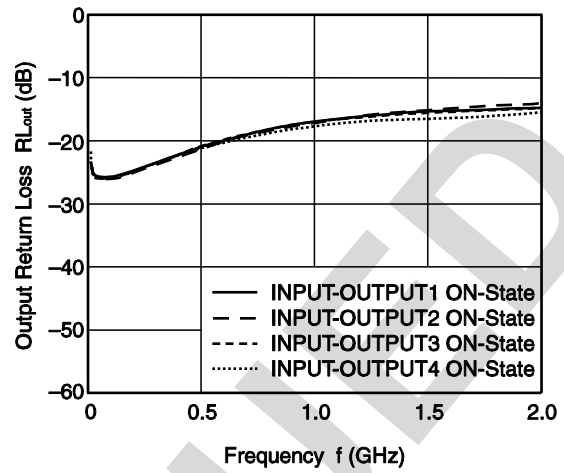

OUTPUT POWER vs. INPUT POWER

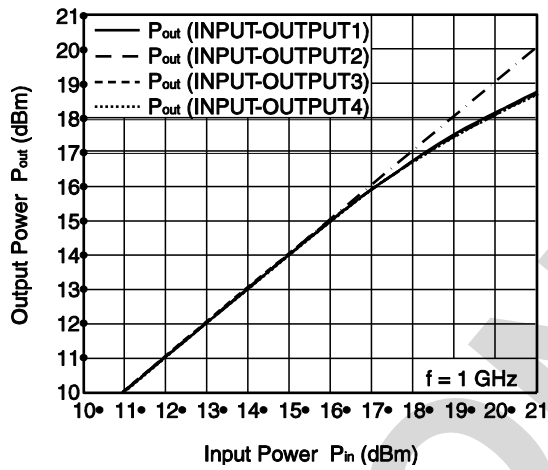

Remark The graphs indicate nominal characteristics.

MOUNTING PAD AND SOLDER MASK LAYOUT DIMENSIONS

12-PIN PLASTIC TSQFN (T6M) (UNIT: mm)

MOUNTING PAD

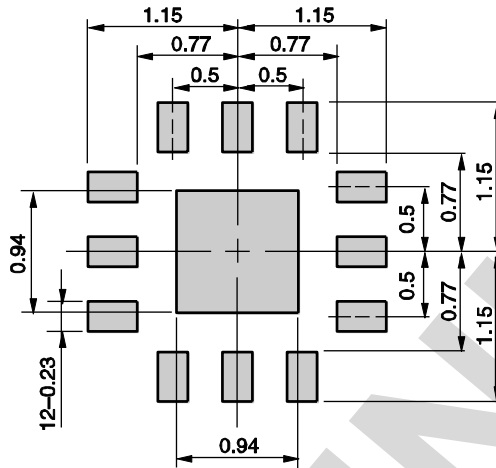

SOLDER MASK

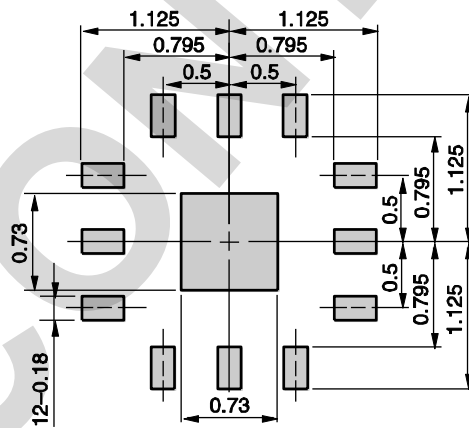

Solder thickness : 0.1 mm

Remark The mounting pad and solder mask layouts in this document are for reference only.

PACKAGE DIMENSIONS

12-PIN PLASTIC TSQFN (T6M) (UNIT: mm)

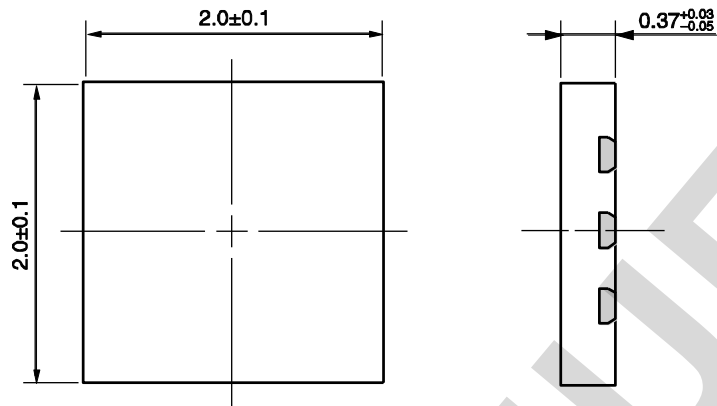

(Bottom View)

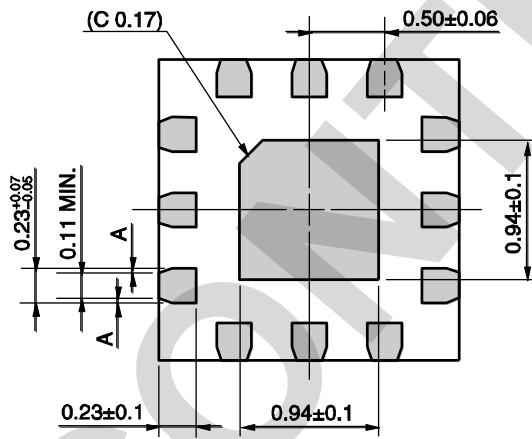

Remark A > 0

(): Reference value

<R> **RECOMMENDED SOLDERING CONDITIONS**

This product should be soldered and mounted under the following recommended conditions. For soldering methods and conditions other than those recommended below, contact your nearby sales office.

Soldering Method	Soldering Conditions	Condition Symbol
Infrared Reflow	Peak temperature (package surface temperature) : 260°C or below Time at peak temperature : 10 seconds or less Time at temperature of 220°C or higher : 60 seconds or less Preheating time at 120 to 180°C : 120±30 seconds Maximum number of reflow processes : 3 times Maximum chlorine content of rosin flux (% mass) : 0.2%(Wt.) or below	IR260
Partial Heating	Peak temperature (terminal temperature) : 350°C or below Soldering time (per side of device) : 3 seconds or less Maximum chlorine content of rosin flux (% mass) : 0.2%(Wt.) or below	HS350

Caution Do not use different soldering methods together (except for partial heating).

DISCONTINUED