

# ON Semiconductor

## Is Now

# onsemi™

To learn more about onsemi™, please visit our website at  
[www.onsemi.com](http://www.onsemi.com)

---

**onsemi** and **onsemi** and other names, marks, and brands are registered and/or common law trademarks of Semiconductor Components Industries, LLC dba "**onsemi**" or its affiliates and/or subsidiaries in the United States and/or other countries. **onsemi** owns the rights to a number of patents, trademarks, copyrights, trade secrets, and other intellectual property. A listing of **onsemi** product/patent coverage may be accessed at [www.onsemi.com/site/pdf/Patent-Marking.pdf](http://www.onsemi.com/site/pdf/Patent-Marking.pdf). **onsemi** reserves the right to make changes at any time to any products or information herein, without notice. The information herein is provided "as-is" and **onsemi** makes no warranty, representation or guarantee regarding the accuracy of the information, product features, availability, functionality, or suitability of its products for any particular purpose, nor does **onsemi** assume any liability arising out of the application or use of any product or circuit, and specifically disclaims any and all liability, including without limitation special, consequential or incidental damages. Buyer is responsible for its products and applications using **onsemi** products, including compliance with all laws, regulations and safety requirements or standards, regardless of any support or applications information provided by **onsemi**. "Typical" parameters which may be provided in **onsemi** data sheets and/or specifications can and do vary in different applications and actual performance may vary over time. All operating parameters, including "Typicals" must be validated for each customer application by customer's technical experts. **onsemi** does not convey any license under any of its intellectual property rights nor the rights of others. **onsemi** products are not designed, intended, or authorized for use as a critical component in life support systems or any FDA Class 3 medical devices or medical devices with a same or similar classification in a foreign jurisdiction or any devices intended for implantation in the human body. Should Buyer purchase or use **onsemi** products for any such unintended or unauthorized application, Buyer shall indemnify and hold **onsemi** and its officers, employees, subsidiaries, affiliates, and distributors harmless against all claims, costs, damages, and expenses, and reasonable attorney fees arising out of, directly or indirectly, any claim of personal injury or death associated with such unintended or unauthorized use, even if such claim alleges that **onsemi** was negligent regarding the design or manufacture of the part. **onsemi** is an Equal Opportunity/Affirmative Action Employer. This literature is subject to all applicable copyright laws and is not for resale in any manner. Other names and brands may be claimed as the property of others.



ON Semiconductor®

# FDMA3028N

## Dual N-Channel PowerTrench® MOSFET 30 V, 3.8 A, 68 mΩ

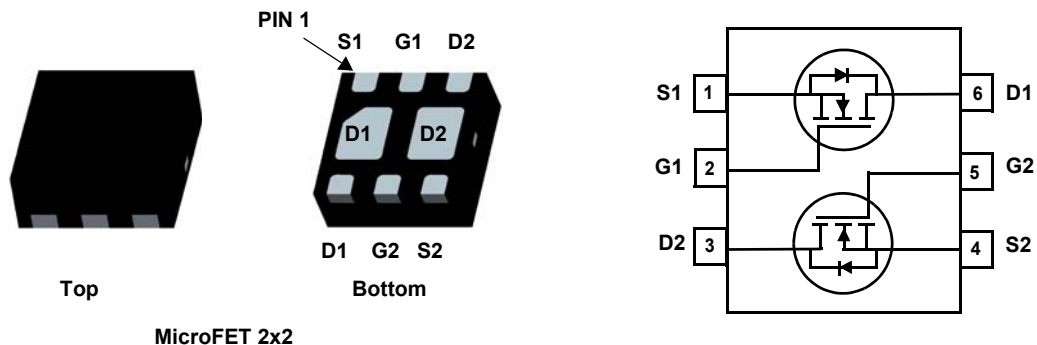
### Features

- Max.  $R_{DS(on)}$  = 68 mΩ at  $V_{GS} = 4.5\text{ V}$ ,  $I_D = 3.8\text{ A}$
- Max.  $R_{DS(on)}$  = 88 mΩ at  $V_{GS} = 2.5\text{ V}$ ,  $I_D = 3.4\text{ A}$
- Max.  $R_{DS(on)}$  = 123 mΩ at  $V_{GS} = 1.8\text{ V}$ ,  $I_D = 2.9\text{ A}$
- Low profile - 0.8 mm maximum - in the new package MicroFET 2x2 mm
- RoHS Compliant



### General Description

This device is designed specifically as a single package solution for dual switching requirements in cellular handset and other ultra-portable applications. It features two independent N-Channel MOSFETs with low on-state resistance for minimum conduction losses. The MicroFET 2x2 package offers exceptional thermal performance for its physical size and is well suited to linear mode applications.



### MOSFET Maximum Ratings $T_A = 25\text{ °C}$ unless otherwise noted

Symbol	Parameter	Ratings	Units
$V_{DS}$	Drain to Source Voltage	30	V
$V_{GS}$	Gate to Source Voltage	±12	V
$I_D$	Drain Current -Continuous	(Note 1a) 3.8	A
	-Pulsed	16	
$P_D$	Power Dissipation	(Note 1a) 1.5	W
	Power Dissipation	(Note 1b) 0.7	
$T_J, T_{STG}$	Operating and Storage Junction Temperature Range	-55 to +150	°C

### Thermal Characteristics

$R_{\theta JA}$	Thermal Resistance for Single Operation, Junction to Ambient	(Note 1a)	86	°C/W
	Thermal Resistance for Single Operation, Junction to Ambient	(Note 1b)	173	
	Thermal Resistance for Dual Operation, Junction to Ambient	(Note 1c)	69	
	Thermal Resistance for Dual Operation, Junction to Ambient	(Note 1d)	151	
	Thermal Resistance for Single Operation, Junction to Ambient	(Note 1e)	160	
	Thermal Resistance for Dual Operation, Junction to Ambient	(Note 1f)	133	

### Package Marking and Ordering Information

Device Marking	Device	Package	Reel Size	Tape Width	Quantity
328	FDMA3028N	MicroFET 2X2	7"	8 mm	3000 units

**Electrical Characteristics**  $T_J = 25\text{ }^\circ\text{C}$  unless otherwise noted

Symbol	Parameter	Test Conditions	Min	Typ	Max	Units
--------	-----------	-----------------	-----	-----	-----	-------

**Off Characteristics**

$BV_{DSS}$	Drain to Source Breakdown Voltage	$I_D = 250\text{ }\mu\text{A}$ , $V_{GS} = 0\text{ V}$	30			V
$\frac{\Delta BV_{DSS}}{\Delta T_J}$	Breakdown Voltage Temperature Coefficient	$I_D = 250\text{ }\mu\text{A}$ , referenced to $25\text{ }^\circ\text{C}$		23		mV/ $^\circ\text{C}$
$I_{DSS}$	Zero Gate Voltage Drain Current	$V_{DS} = 24\text{ V}$ , $V_{GS} = 0\text{ V}$			1	$\mu\text{A}$
$I_{GSS}$	Gate to Source Leakage Current	$V_{GS} = \pm 12\text{ V}$ , $V_{DS} = 0\text{ V}$			$\pm 100$	nA

**On Characteristics**

$V_{GS(th)}$	Gate to Source Threshold Voltage	$V_{GS} = V_{DS}$ , $I_D = 250\text{ }\mu\text{A}$	0.6	0.9	1.5	V
$\frac{\Delta V_{GS(th)}}{\Delta T_J}$	Gate to Source Threshold Voltage Temperature Coefficient	$I_D = 250\text{ }\mu\text{A}$ , referenced to $25\text{ }^\circ\text{C}$		-3		mV/ $^\circ\text{C}$
$r_{DS(on)}$	Static Drain to Source On Resistance	$V_{GS} = 4.5\text{ V}$ , $I_D = 3.8\text{ A}$		46	68	m $\Omega$
		$V_{GS} = 2.5\text{ V}$ , $I_D = 3.4\text{ A}$		56	88	
		$V_{GS} = 1.8\text{ V}$ , $I_D = 2.9\text{ A}$		80	123	
		$V_{GS} = 4.5\text{ V}$ , $I_D = 3.8\text{ A}$ , $T_J = 125\text{ }^\circ\text{C}$		72	108	
$g_{FS}$	Forward Transconductance	$V_{DS} = 5\text{ V}$ , $I_D = 3.8\text{ A}$		15		S

**Dynamic Characteristics**

$C_{iss}$	Input Capacitance	$V_{DS} = 15\text{ V}$ , $V_{GS} = 0\text{ V}$ , $f = 1\text{ MHz}$		282	375	pF
$C_{oss}$	Output Capacitance			40	55	pF
$C_{rss}$	Reverse Transfer Capacitance			29	45	pF
$R_g$	Gate Resistance			2.4		$\Omega$

**Switching Characteristics**

$t_{d(on)}$	Turn-On Delay	$V_{DD} = 15\text{ V}$ , $I_D = 3.8\text{ A}$ , $V_{GS} = 4.5\text{ V}$ , $R_{GEN} = 6\text{ }\Omega$		5.3	11	ns
$t_r$	Rise Time			3	10	ns
$t_{d(off)}$	Turn-Off Delay			15	27	ns
$t_f$	Fall Time			2.5	10	ns
$Q_{g(TOT)}$	Total Gate Charge		$V_{DD} = 15\text{ V}$ , $I_D = 3.8\text{ A}$ $V_{GS} = 5\text{ V}$		3.7	5.2
$Q_{gs}$	Gate to Source Charge			0.4		nC
$Q_{gd}$	Gate to Drain "Miller" Charge			1		nC

**Drain-Source Diode Characteristics**

$V_{SD}$	Source to Drain Diode Forward Voltage	$V_{GS} = 0\text{ V}$ , $I_S = 1.3\text{ A}$ (Note 2)		0.7	1.2	V
$t_{rr}$	Reverse Recovery Time	$I_F = 3.8\text{ A}$ , $di/dt = 100\text{ A}/\mu\text{s}$		12	22	ns
$Q_{rr}$	Reverse Recovery Charge			3.3	10	nC

## Electrical Characteristics $T_J = 25\text{ }^\circ\text{C}$ unless otherwise noted

### Notes:

1.  $R_{\theta JA}$  is determined with the device mounted on a 1 in<sup>2</sup> oz. copper pad on a 1.5 x 1.5 in. board of FR-4 material.  $R_{\theta JC}$  is guaranteed by design while  $R_{\theta JA}$  is determined by the user's board design.

- (a)  $R_{\theta JA} = 86\text{ }^\circ\text{C/W}$  when mounted on a 1 in<sup>2</sup> pad of 2 oz copper, 1.5 " x 1.5 " x 0.062 " thick PCB. For single operation.
- (b)  $R_{\theta JA} = 173\text{ }^\circ\text{C/W}$  when mounted on a minimum pad of 2 oz copper. For single operation.
- (c)  $R_{\theta JA} = 69\text{ }^\circ\text{C/W}$  when mounted on a 1 in<sup>2</sup> pad of 2 oz copper, 1.5 " x 1.5 " x 0.062 " thick PCB. For dual operation.
- (d)  $R_{\theta JA} = 151\text{ }^\circ\text{C/W}$  when mounted on a minimum pad of 2 oz copper. For dual operation.
- (e)  $R_{\theta JA} = 160\text{ }^\circ\text{C/W}$  when mounted on a 30mm<sup>2</sup> pad of 2 oz copper. For single operation.
- (f)  $R_{\theta JA} = 133\text{ }^\circ\text{C/W}$  when mounted on a 30mm<sup>2</sup> pad of 2 oz copper. For dual operation.



a. 86 °C/W when mounted on a 1 in<sup>2</sup> pad of 2 oz copper



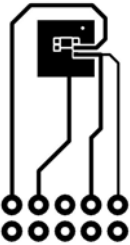
b. 173 °C/W when mounted on a minimum pad of 2 oz copper



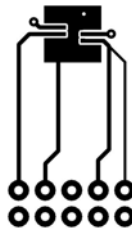
c. 69 °C/W when mounted on a 1 in<sup>2</sup> pad of 2 oz copper



d. 151 °C/W when mounted on a minimum pad of 2 oz copper



e. 160 °C/W when mounted on 30mm<sup>2</sup> pad of 2 oz copper



f. 133 °C/W when mounted on 30mm<sup>2</sup> of 2 oz copper

2. Pulse Test : Pulse Width < 300 us, Duty Cycle < 2.0%

**Typical Characteristics**  $T_J = 25^\circ\text{C}$  unless otherwise noted

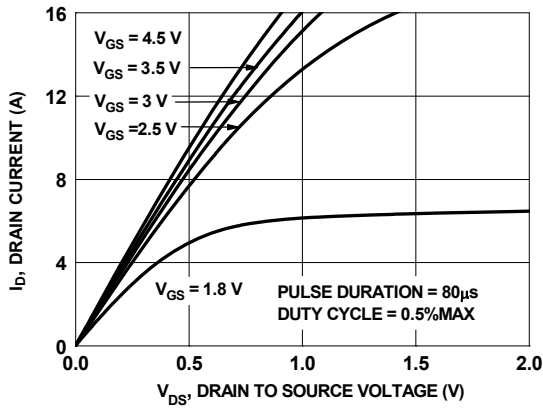


Figure 1. On Region Characteristics

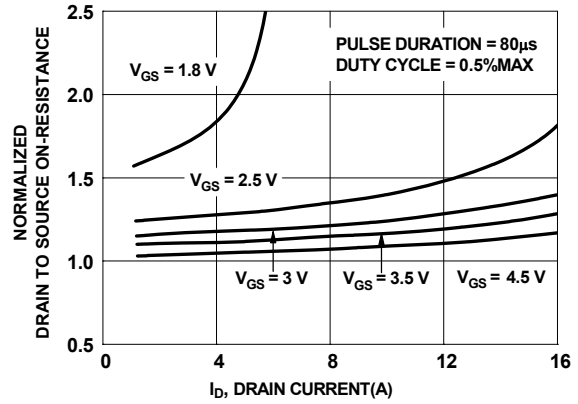


Figure 2. Normalized On-Resistance vs. Drain Current and Gate Voltage

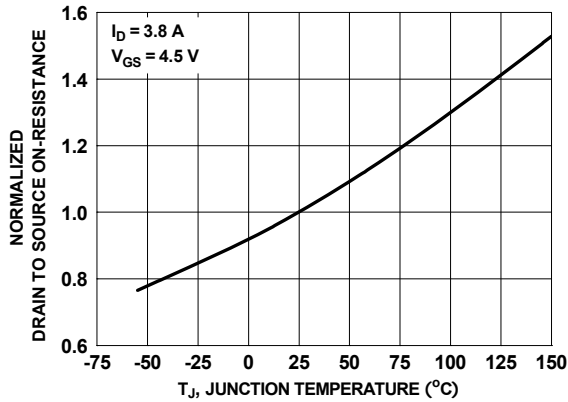


Figure 3. Normalized On Resistance vs. Junction Temperature

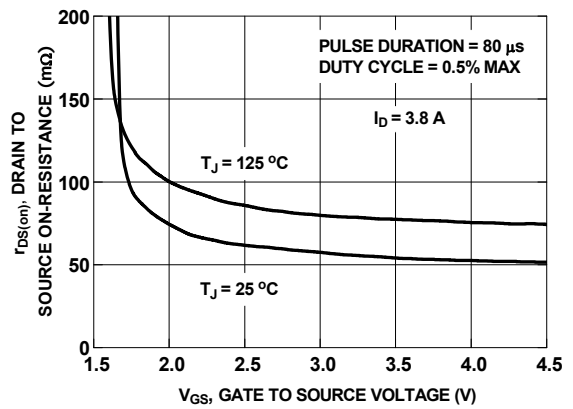


Figure 4. On-Resistance vs Gate to Source Voltage

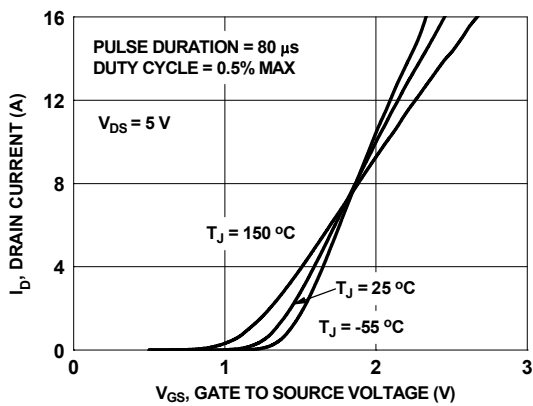


Figure 5. Transfer Characteristics

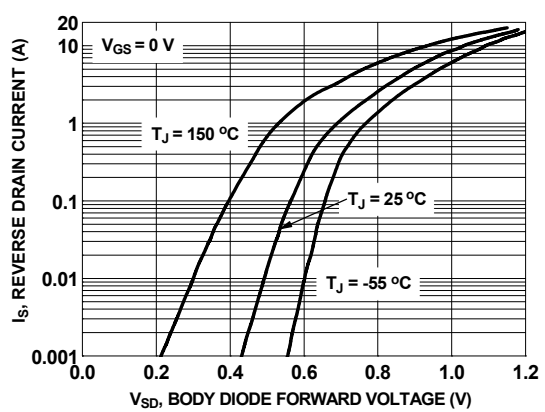
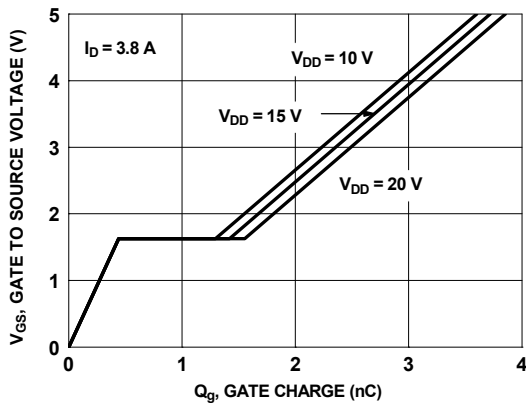
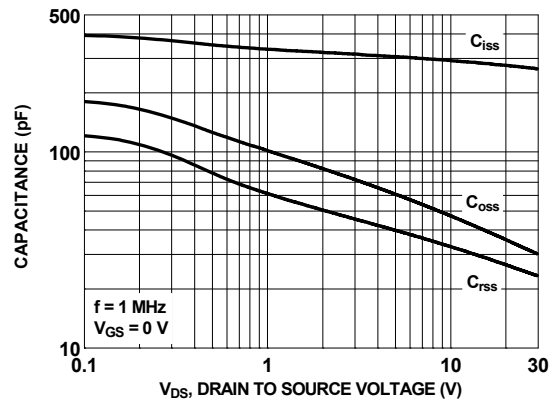


Figure 6. Source to Drain Diode Forward Voltage vs. Source Current

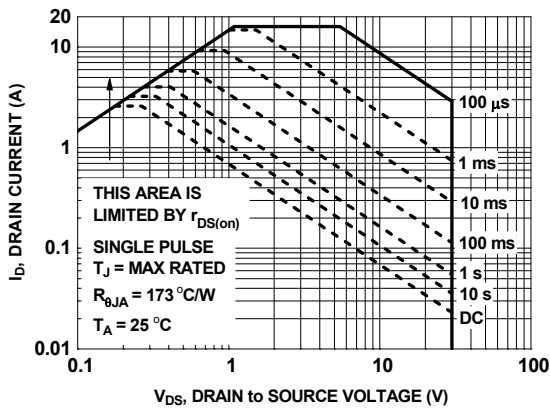
**Typical Characteristics**  $T_J = 25^\circ\text{C}$  unless otherwise noted



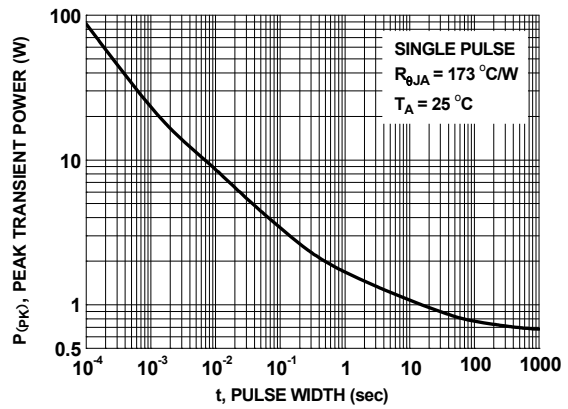
**Figure 7. Gate Charge Characteristics**



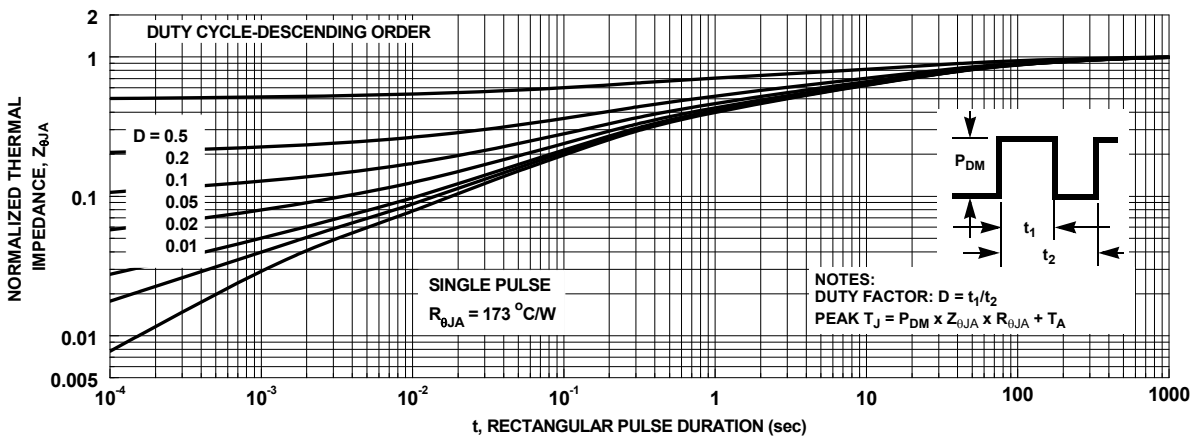
**Figure 8. Capacitance vs. Drain to Source Voltage**



**Figure 9. Forward Bias Safe Operating Area**

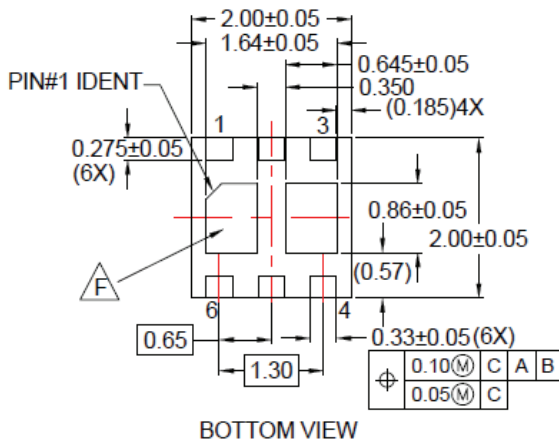
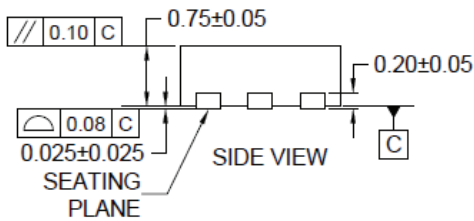
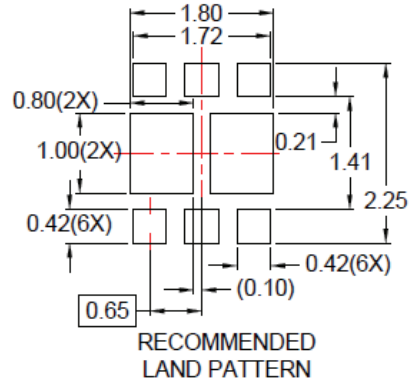
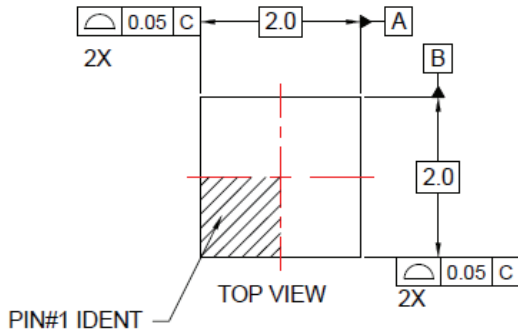


**Figure 10. Single-Pulse Maximum Power Dissipation**



**Figure 11. Junction-to-Ambient Transient Thermal Response Curve**

## Dimensional Outline and Pad Layout



### NOTES:

- A. CONFORM TO JAEDEC REGISTRATIONS MO-229, VARIATION VCCC, EXCEPT WHERE NOTED.
  - B. DIMENSIONS ARE IN MILLIMETERS.
  - C. DIMENSIONS AND TOLERANCES PER ASME Y14.5M, 2009.
  - D. LAND PATTERN RECOMMENDATION IS EXISTING INDUSTRY LAND PATTERN.
  - E. DRAWING FILENAME: MKT-UMLP16Erev4
- △ NON-JEDEC DUAL DAP

Package drawings are provided as a service to customers considering ON Semiconductor components. Drawings may change in any manner without notice. Please note the revision and/or date on the drawing and contact a ON Semiconductor representative to verify or obtain the most recent revision. Package specifications do not expand the terms of ON Semiconductor worldwide terms and conditions, specifically the warranty therein, which covers ON Semiconductor products.

ON Semiconductor and  are trademarks of Semiconductor Components Industries, LLC dba ON Semiconductor or its subsidiaries in the United States and/or other countries. ON Semiconductor owns the rights to a number of patents, trademarks, copyrights, trade secrets, and other intellectual property. A listing of ON Semiconductor's product/patent coverage may be accessed at [www.onsemi.com/site/pdf/Patent-Marking.pdf](http://www.onsemi.com/site/pdf/Patent-Marking.pdf). ON Semiconductor reserves the right to make changes without further notice to any products herein. ON Semiconductor makes no warranty, representation or guarantee regarding the suitability of its products for any particular purpose, nor does ON Semiconductor assume any liability arising out of the application or use of any product or circuit, and specifically disclaims any and all liability, including without limitation special, consequential or incidental damages. Buyer is responsible for its products and applications using ON Semiconductor products, including compliance with all laws, regulations and safety requirements or standards, regardless of any support or applications information provided by ON Semiconductor. "Typical" parameters which may be provided in ON Semiconductor data sheets and/or specifications can and do vary in different applications and actual performance may vary over time. All operating parameters, including "Typicals" must be validated for each customer application by customer's technical experts. ON Semiconductor does not convey any license under its patent rights nor the rights of others. ON Semiconductor products are not designed, intended, or authorized for use as a critical component in life support systems or any FDA Class 3 medical devices or medical devices with a same or similar classification in a foreign jurisdiction or any devices intended for implantation in the human body. Should Buyer purchase or use ON Semiconductor products for any such unintended or unauthorized application, Buyer shall indemnify and hold ON Semiconductor and its officers, employees, subsidiaries, affiliates, and distributors harmless against all claims, costs, damages, and expenses, and reasonable attorney fees arising out of, directly or indirectly, any claim of personal injury or death associated with such unintended or unauthorized use, even if such claim alleges that ON Semiconductor was negligent regarding the design or manufacture of the part. ON Semiconductor is an Equal Opportunity/Affirmative Action Employer. This literature is subject to all applicable copyright laws and is not for resale in any manner.

## PUBLICATION ORDERING INFORMATION

### LITERATURE FULFILLMENT:

Literature Distribution Center for ON Semiconductor  
19521 E. 32nd Pkwy, Aurora, Colorado 80011 USA  
**Phone:** 303-675-2175 or 800-344-3860 Toll Free USA/Canada  
**Fax:** 303-675-2176 or 800-344-3867 Toll Free USA/Canada  
**Email:** [orderlit@onsemi.com](mailto:orderlit@onsemi.com)

**N. American Technical Support:** 800-282-9855 Toll Free  
USA/Canada  
**Europe, Middle East and Africa Technical Support:**  
Phone: 421 33 790 2910  
**Japan Customer Focus Center**  
Phone: 81-3-5817-1050

**ON Semiconductor Website:** [www.onsemi.com](http://www.onsemi.com)  
**Order Literature:** <http://www.onsemi.com/orderlit>  
For additional information, please contact your local  
Sales Representative