

## Mechanical Dimensions: Inches [mm]

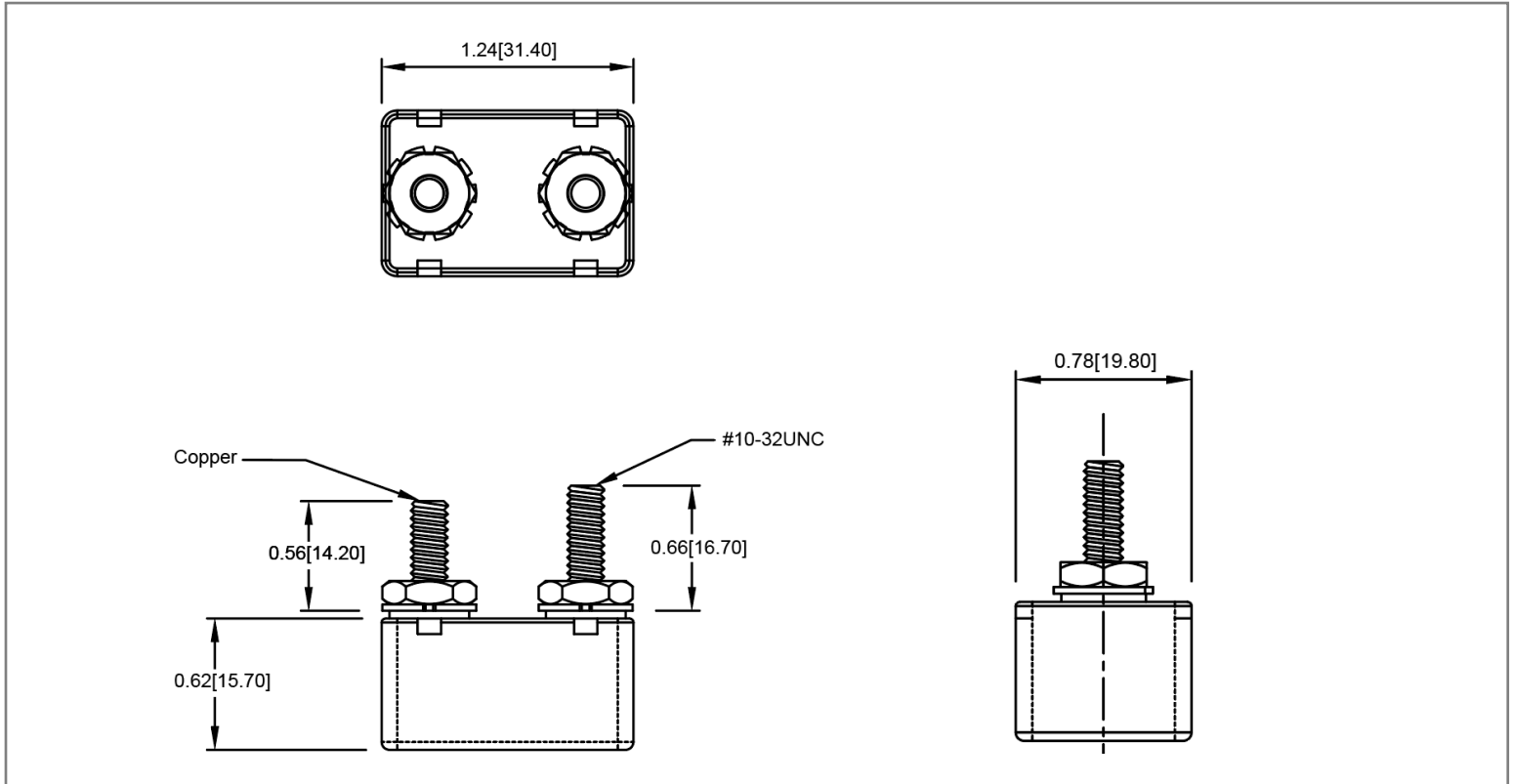

## Part Numbers Information

Optifuse P/N	Current
MOCB-24-N-10A	10A
MOCB-24-N-15A	15A
MOCB-24-N-20A	20A
MOCB-24-N-25A	25A
MOCB-24-N-30A	30A
MOCB-24-N-40A	40A
MOCB-24-N-50A	50A

## Time vs. Percent of Rated Current

% of Rated Current	Min Trip Time	Max Trip Time
100%	30m	-
135%	-	30m
200%	-	1m

## Electrical Specifications

Voltage	24VDC
Reset Type	Type II - Modified Reset
Operation Temperature	-40° F ~ 175° F
Compliances	SAE J553

## Material Specification

Body Material	Plated Steel
Terminals Material	Battery – Copper, Auxiliary – Zinc
Terminals Configuration	#10-32 Stud
Mounting Type	Stud Mounted

**Rev**    **Date of issue**    **Revision Notes**

**Designed**    **Approved**

A	06-25-2020	Initial Drawing	RC	OF
---	------------	-----------------	----	----