

IR series

Sealed pushbutton switches • bushing \varnothing 16 mm • momentary • microswitch version



DISTINCTIVE FEATURES

Microswitch technology up to 5 A

Tactile feedback

Sealed to IP67

Flat round actuator for optional marking



ENVIRONMENTAL SPECIFICATIONS

- Front panel sealing : IP67 according to IEC 60529
- Salt spray : IEC 512-6, test 11f
- Operating temperature : -20 °C to +85 °C (-4 °F to +185 °F)



GENERAL SPECIFICATIONS

- Panel thickness : 3 mm (.118) max.
- Total travel : 1.6 mm (.062) \pm 0.3 mm
- Typical operating force : 4 N \pm 2 N
- Mechanical life : 1,000,000 cycles
- Torque : 0.8 Nm max. applied to nut
- Soldering : 320 °C (608 °F) max. for 3 sec.



ELECTRICAL SPECIFICATIONS

- Max. current/voltage rating with resistive load (microswitch) :
5 A 250 VAC, 50,000 cycles (function 7)
5 A 250 VAC, 25,000 cycles (function 8)
- Initial contact resistance : 100 m Ω max.
- Insulation resistance : 1 G Ω min. at 500 VDC
- Dielectric strength : 750 Vrms between terminals
2,000 Vrms between terminals and frame

The company reserves the right to change specifications without notice.



IR series

Sealed pushbutton switches • bushing Ø 16 mm • momentary • microswitch version

MATERIALS

- Case : thermoplastic UL94-V0
- Actuator : polyamide 6/6
- Bushing/bezel : polyamide 6/6
- Contacts : silver

APEM products may be recycled at end-of-life for the re-claiming of valuable metal components.

MOUNTING

PANEL CUT-OUT

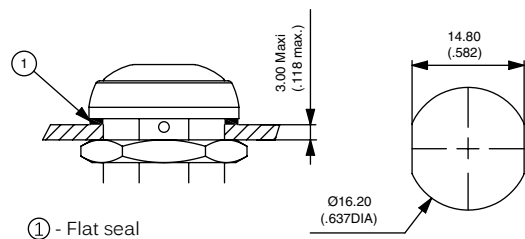

MATRIX MOUNTING

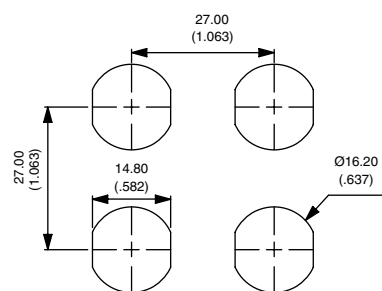

TERMINALS

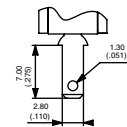

Quick-connect
Function 7 (NC+NO))

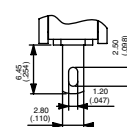

Solder lug
Function 8 (NC/NO))

ELECTRICAL FUNCTIONS

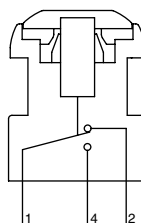

Function 7 (NC+NO))

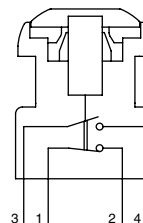

Function 8 (NC/NO))

IR series

Sealed pushbutton switches • bushing Ø 16 mm • momentary • microswitch version



BUILD YOUR PART NUMBER

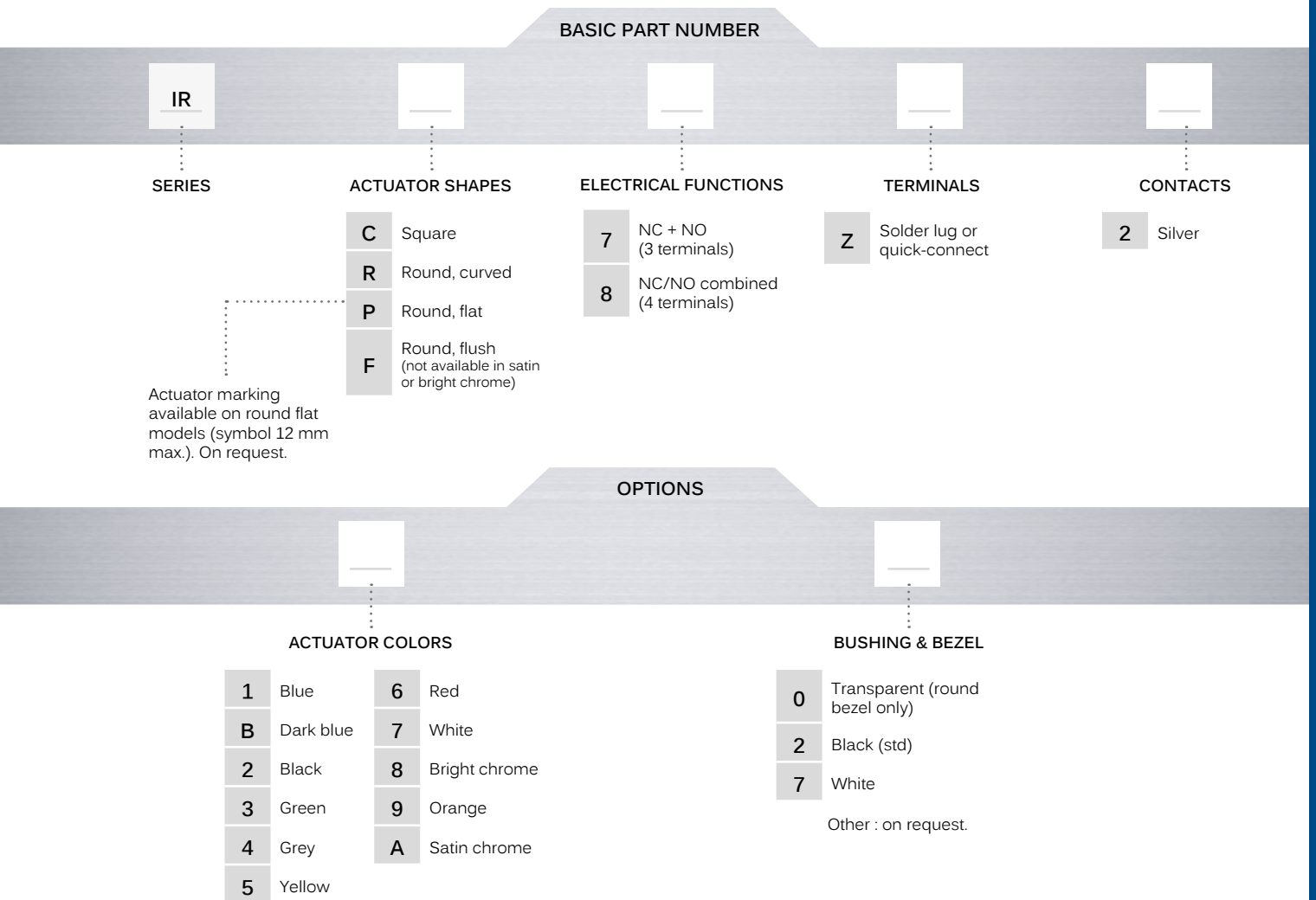

The IR series for high currents is based on a microswitch. Please note that this microswitch is supplied separately.



ABOUT THIS SERIES

On the following pages, you will find successively basic part numbers of switches and options in the same order as in above chart.

- Notice** : please note that not all combinations of above numbers are available. Refer to the following pages for further information.
- A sealing boot** is available to protect the switches against frost and sand (P/N U7125). Round models only. See "Sealing Boots" section of website.
- Mounting accessories** : Standard hardware supplied : 1 hex nut 19 mm (.748) across flats and 1 flat seal. Hex nut P/N : U6715.

IR series

Sealed pushbutton switches • bushing \varnothing 16 mm • momentary • microswitch version

ROUND - QUICK-CONNECT TERMINALS - NC+NO - 3 TERMINALS



Curved actuator
IRR7Z2  NC+NO

Flat actuator
IRP7Z2  NC+NO

ROUND - SOLDER LUG TERMINALS - NC/NO - 4 TERMINALS



Curved actuator
IRR8Z2  NC/NO combined

Flat actuator
IRP8Z2  NC/NO combined

SQUARE - QUICK-CONNECT TERMINALS - NC+NO - 3 TERMINALS



IRC7Z2  NC+NO

SQUARE - SOLDER LUG TERMINALS - NC/NO - 4 TERMINALS



IRC8Z2  NC+NO

→ FLAT

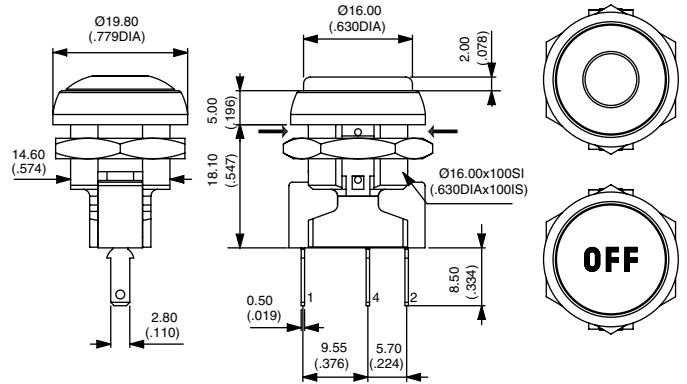

→ FLAT

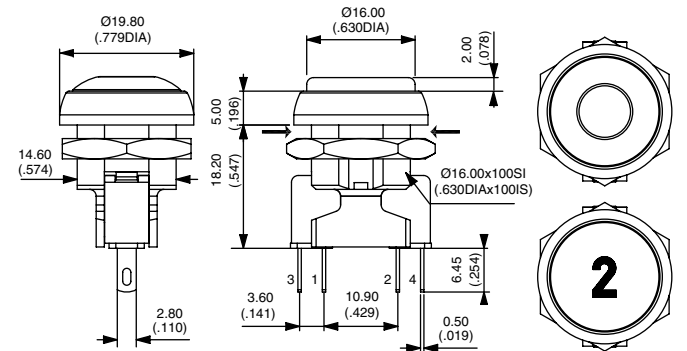

→ FLAT

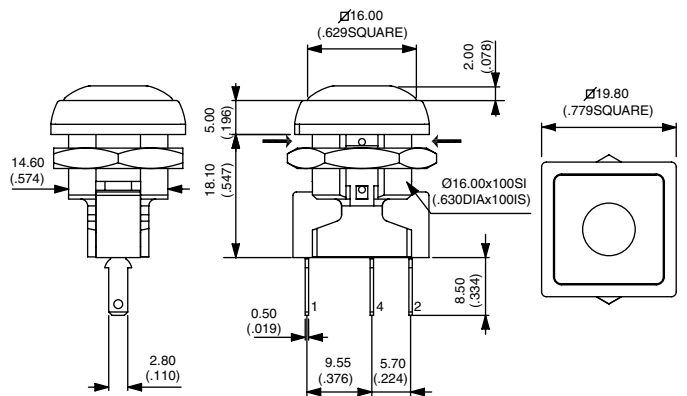

→ FLAT

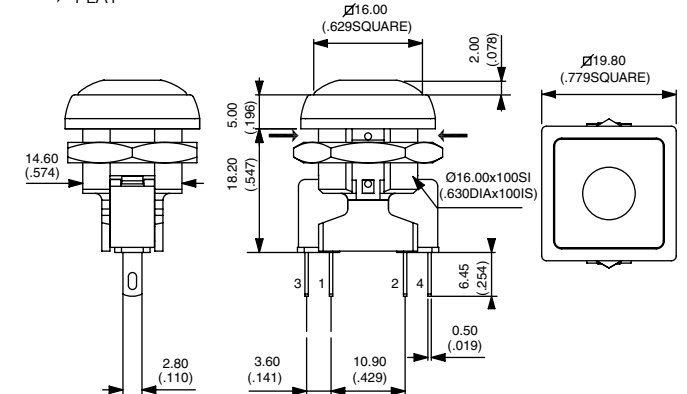

Terminals should be used as solder lugs only.

IR series

Sealed pushbutton switches • bushing Ø 16 mm •
momentary • microswitch version

ACTUATOR COLORS

BASIC P/N



- 1 Blue
- B Dark blue
- 2 Black
- 3 Green
- 4 Grey
- 5 Yellow
- 6 Red
- 7 White
- 8 Bright chrome*
- 9 Orange
- A Satin chrome*

* Non available with Round, flush actuator shape (F)

BUSHING AND BEZEL

BASIC P/N



- 0 Transparent (round bezel only)
- 2 Black (standard)
- 7 White