



# RFID Transponder

## IPC03-30P

- Battery-free data carrier
- 32 bit fixcode
- 928 bits memory available
- Readable and writable from both sides
- Mounting holes for simple installation
- Degree of protection IP67 / IP68 / IP69K

Data carrier



### Dimensions

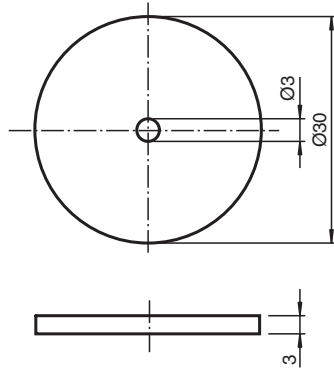

### Technical Data

General specifications	
Operating frequency	125 kHz
Transfer rate	2 kBit/s
Memory	
Chip Type	EM4450 Titan (EM Microelectronic)
EEPROM	928 Bit
Read cycles	unlimited
Write cycles	> 100000
Data retention period	10 years at 55 °C (131 °F)
Directive conformity	
Radio equipment	
Directive 2014/53/EU	EN 300330
RoHS	
Directive 2011/65/EU (RoHS)	EN 50581
Standard conformity	
Degree of protection	EN 60529

Release date: 2020-03-23 Date of issue: 2020-03-27 Filename: 192203\_eng.pdf

Refer to "General Notes Relating to Pepperl+Fuchs Product Information".

**Technical Data**

RFID	ISO/IEC 18000-2
<b>Ambient conditions</b>	
Ambient temperature	-20 ... 100 °C (-4 ... 212 °F)
Storage temperature	-20 ... 100 °C (-4 ... 212 °F)
<b>Mechanical specifications</b>	
Degree of protection	IP68
Material	
Housing	PC (Polycarbonate)
Installation	
In air	yes
Construction type	Cylindrical

Reading range in air IPC03-30..

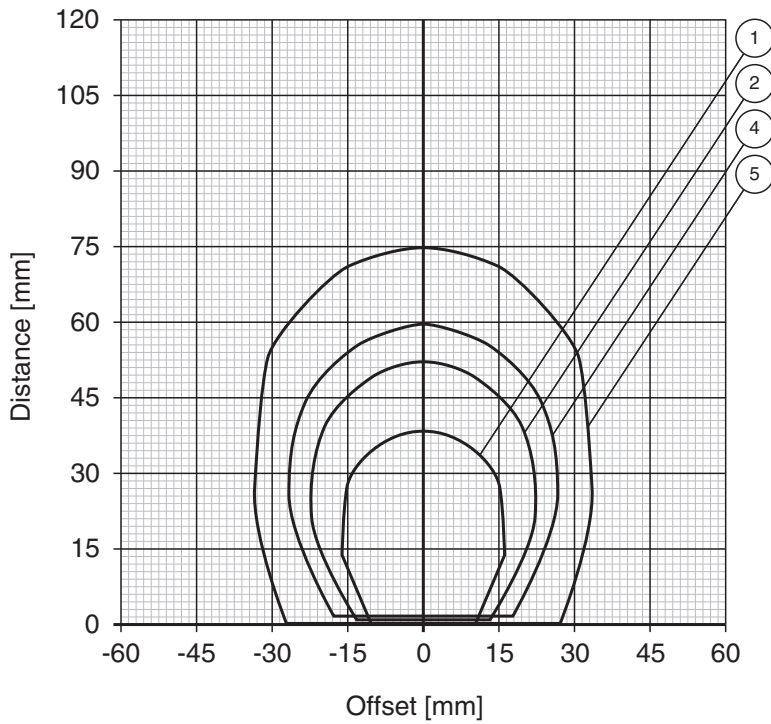

Release date: 2020-03-23 Date of issue: 2020-03-27 Filename: 192203\_eng.pdf

Refer to "General Notes Relating to Pepperl+Fuchs Product Information".

Pepperl+Fuchs Group  
www.pepperl-fuchs.com

USA: +1 330 486 0001  
fa-info@us.pepperl-fuchs.com

Germany: +49 621 776 1111  
fa-info@de.pepperl-fuchs.com

Singapore: +65 6779 9091  
fa-info@sg.pepperl-fuchs.com

Writing range in air IPC03-30..

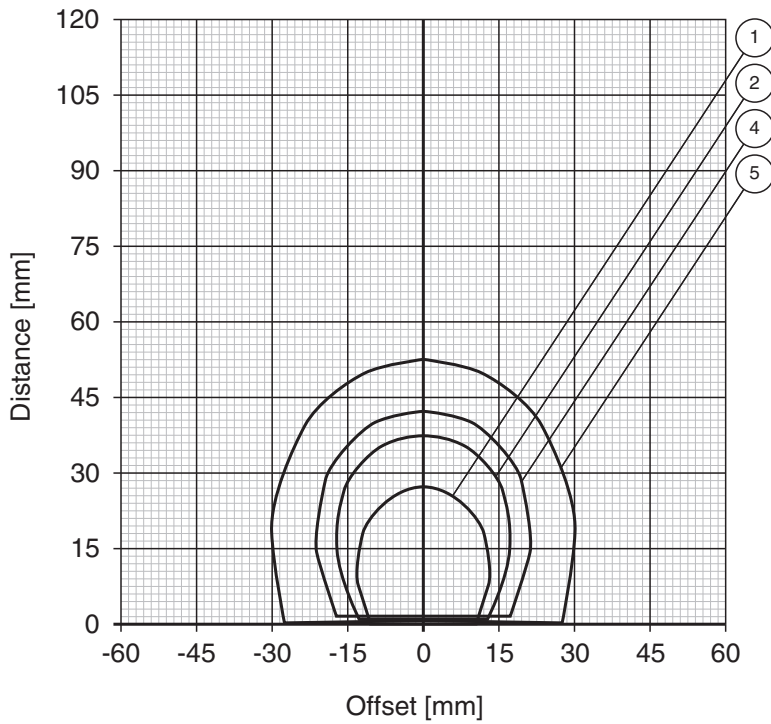

Release date: 2020-03-23 Date of issue: 2020-03-27 Filename: 192203\_eng.pdf

Refer to "General Notes Relating to Pepperl+Fuchs Product Information".

Pepperl+Fuchs Group  
www.pepperl-fuchs.com

USA: +1 330 486 0001  
fa-info@us.pepperl-fuchs.com

Germany: +49 621 776 1111  
fa-info@de.pepperl-fuchs.com

Singapore: +65 6779 9091  
fa-info@sg.pepperl-fuchs.com

Reading range on aluminium IPC03-30..

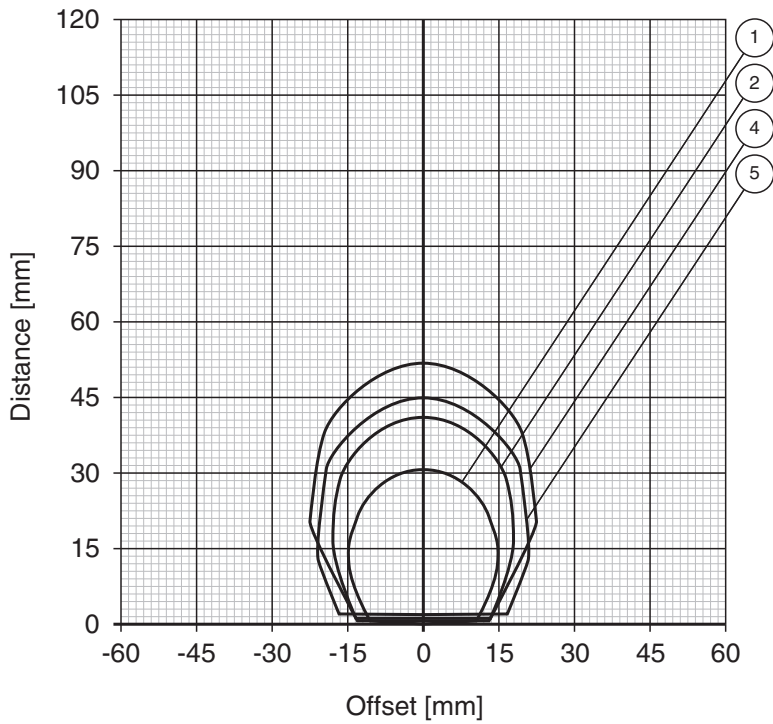

Release date: 2020-03-23 Date of issue: 2020-03-27 Filename: 192203\_eng.pdf

Refer to "General Notes Relating to Pepperl+Fuchs Product Information".

Pepperl+Fuchs Group  
www.pepperl-fuchs.com

USA: +1 330 486 0001  
fa-info@us.pepperl-fuchs.com

Germany: +49 621 776 1111  
fa-info@de.pepperl-fuchs.com

Singapore: +65 6779 9091  
fa-info@sg.pepperl-fuchs.com

 **PEPPERL+FUCHS**

Writing range on aluminium IPC03-30..

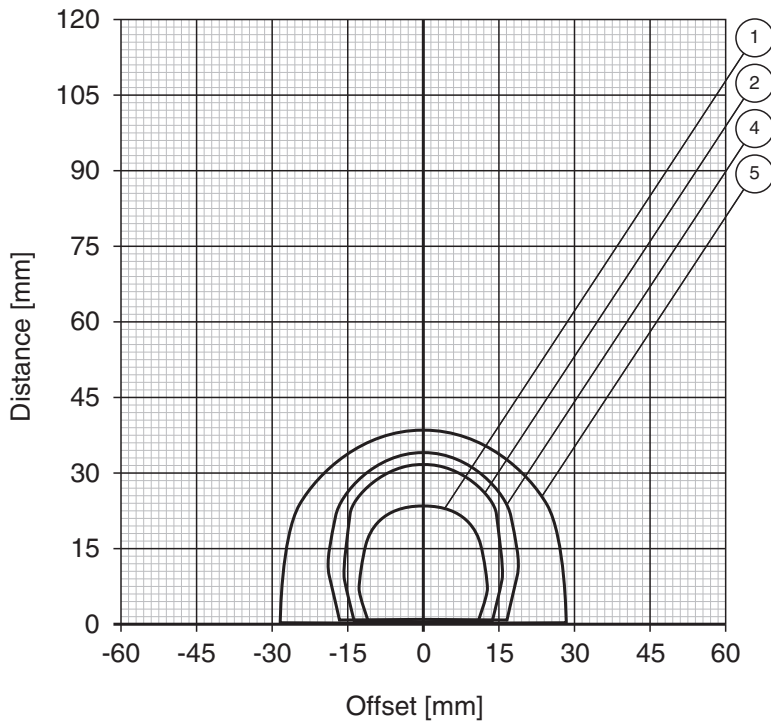

Release date: 2020-03-23 Date of issue: 2020-03-27 Filename: 192203\_eng.pdf

Refer to "General Notes Relating to Pepperl+Fuchs Product Information".

Pepperl+Fuchs Group  
www.pepperl-fuchs.com

USA: +1 330 486 0001  
fa-info@us.pepperl-fuchs.com

Germany: +49 621 776 1111  
fa-info@de.pepperl-fuchs.com

Singapore: +65 6779 9091  
fa-info@sg.pepperl-fuchs.com

Reading range on steel IPC03-30..

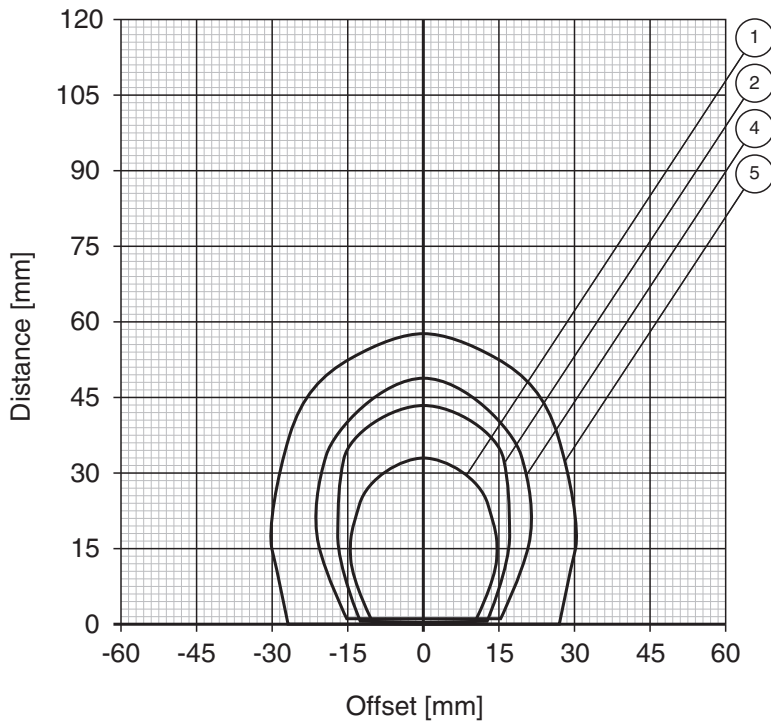

Release date: 2020-03-23 Date of issue: 2020-03-27 Filename: 192203\_eng.pdf

Refer to "General Notes Relating to Pepperl+Fuchs Product Information".

Pepperl+Fuchs Group  
www.pepperl-fuchs.com

USA: +1 330 486 0001  
fa-info@us.pepperl-fuchs.com

Germany: +49 621 776 1111  
fa-info@de.pepperl-fuchs.com

Singapore: +65 6779 9091  
fa-info@sg.pepperl-fuchs.com

Writing range on steel IPC03-30..

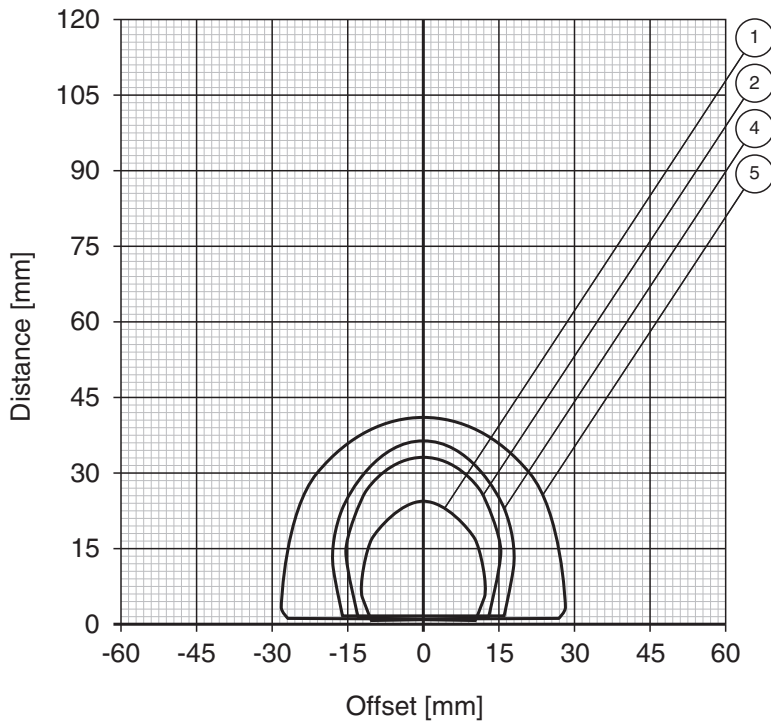

- |               |             |              |              |
|---------------|-------------|--------------|--------------|
| ① IPH-18GM-V1 | ③ IPH-F61   | ⑤ IPH-FP-V1  | ⑦ IPT1-FP-V1 |
| ② IPH-30GM-V1 | ④ IPH-L2-V1 | ⑥ IPH-F15-V1 |              |

Release date: 2020-03-23 Date of issue: 2020-03-27 Filename: 192203\_eng.pdf

Refer to "General Notes Relating to Pepperl+Fuchs Product Information".

Pepperl+Fuchs Group  
www.pepperl-fuchs.com

USA: +1 330 486 0001  
fa-info@us.pepperl-fuchs.com

Germany: +49 621 776 1111  
fa-info@de.pepperl-fuchs.com

Singapore: +65 6779 9091  
fa-info@sg.pepperl-fuchs.com

## Application

The transponder can be read and written from either side.