

LEAD FREE

MOLEX CONFIDENTIAL

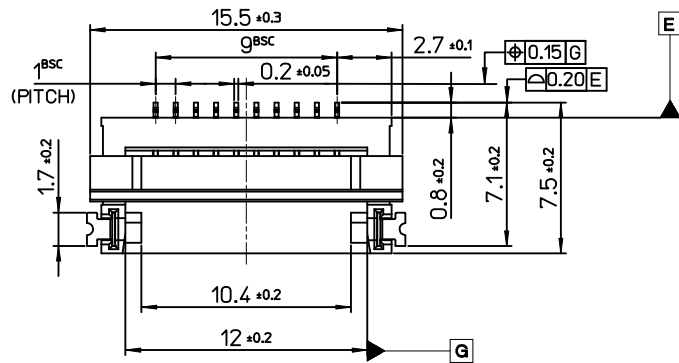

(OPEN)

ISOMETRIC VIEW

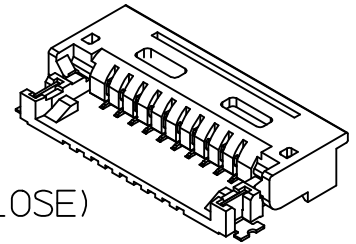

(CLOSE)

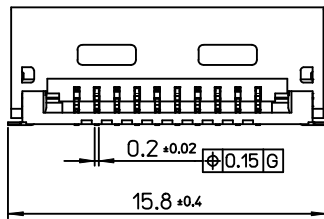

COPLANARITY : 0.08 MAX.

COPLANARITY 0.08mm MAX.

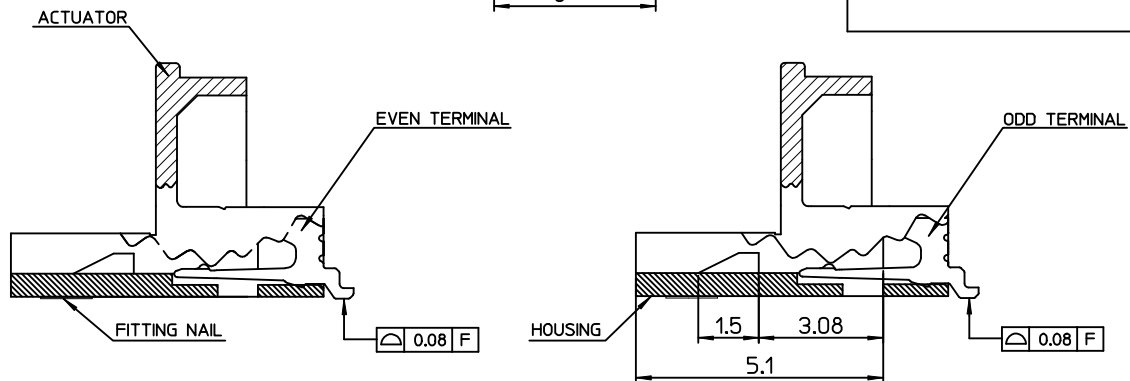

NOTES

1. MATERIAL
  - HOUSING : PA46, GLASS FILLED. UL94V-0, COLOR: BEIGE (NON HALOGEN FREE, 49456-1017)
  - LCP, GLASS FILLED, UL94V-0, COLOR: NATURAL (HALOGEN FREE, 49456-1047)
  - ACTUATOR : LCP,(OR NYLON) GLASS FILLED. UL94V-0, COLOR:BLACK
  - TERMINAL : COPPER ALLOY
  - FITTING NAIL : COPPER ALLOY
2. FINISHES
  - TERMINAL : Tin[Sn] 1.5~3um OVER NICKEL(Ni) PLATING 2~4um
  - FITTING NAIL : TIN(Sn) 1~3um OVER NICKEL(Ni) PLATING 1~3um
3. PRODUCT SPECIFICATION : PS-49456-001
4. PACKING SPECIFICATION : PK-49456-001
5. ACTUATOR IS OPEN IN THE EMBOSSED PACKING

HALOGEN FREE	494561047	10
NON HALOGEN FREE	494561017	
TYPE	MATERIAL NO.	CKT

REVISED EC NO: KOR2017-0033 DRW:KJHWANG 2016/12/01 CHK:DKSKIM 2016/12/01 APPR:YSKIM02 2016/12/05 B4	QUALITY SYMBOLS ▽=0 ◻=0	GENERAL TOLERANCES (UNLESS SPECIFIED)		DIMENSION STYLE MM ONLY		SCALE	DESIGN UNITS	THIRD ANGLE PROJECTION		
			mm	INCH	DRAWN BY	DATE	TITLE			
		4 PLACES	± ---	± ---	JHLEE05	2007/01/22	1.0 FFC BACKFLIP CONN. HOUSING ASSY 10P (BOTTOM CONTACT)  MOLEX INCORPORATED SD-49456-001			
		3 PLACES	± ---	± ---	CHECKED BY	DATE				
2 PLACES	± 0.25	± ---	KSKIM	2007/01/22						
1 PLACE	± 0.3	± ---	APPROVED BY	DATE						
	ANGULAR ± 1 °		YSOOKIM	2007/01/22	MATERIAL NO.	DOCUMENT NO.		SHEET NO.		
DRAFT WHERE APPLICABLE MUST REMAIN WITHIN DIMENSIONS			SEE TABLE				1 OF 3			

LEAD-FREE

MOLEX CONFIDENTIAL

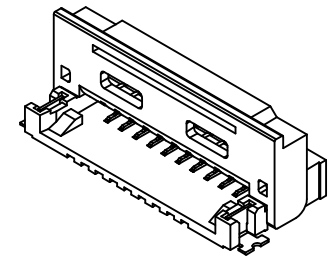

ISOMETRIC VIEW

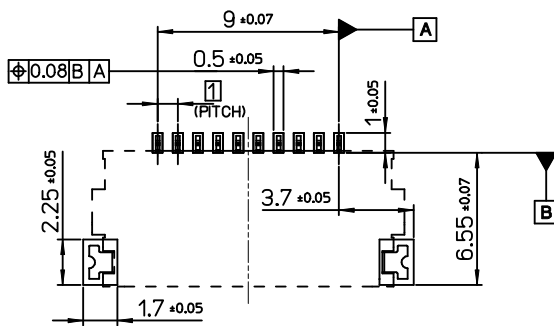
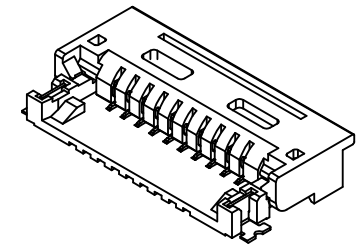

P.C. BOARD DIMENSION (RECOMMEND)

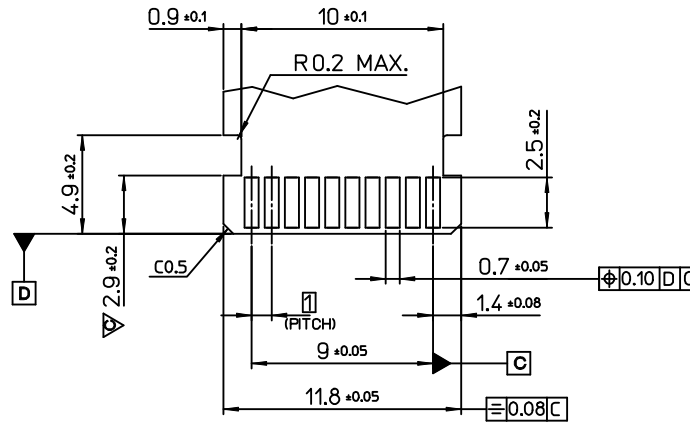

FPC/FFC DIMENSION (RECOMMEND)  
(FLIM THICKNESS = 0.3 ± 0.05)

HALOGEN FREE	494561047	10
NON HALOGEN FREE	494561017	
TYPE	MATERIAL NO.	CKT

REVIDED EC NO: KOR2017-0033 DRW: KYHWANG 2016/12/01 CHK: KSKIM 2016/12/01 APPR: YSKIM02 2016/12/05 REV B4	QUALITY SYMBOLS	GENERAL TOLERANCES (UNLESS SPECIFIED)	DIMENSION STYLE	SCALE	DESIGN UNITS	THIRD ANGLE PROJECTION
	▽=0 ◻=0	mm    INCH 4 PLACES ± --- ± --- 3 PLACES ± --- ± --- 2 PLACES ± 0.25 ± --- 1 PLACE ± 0.3 ± --- ANGULAR ± 1 °	MM ONLY		METRIC	
	DESCRIPTION	DRAFT WHERE APPLICABLE MUST REMAIN WITHIN DIMENSIONS	DRAWN BY: JHLEE05    DATE: 2007/01/22 CHECKED BY: KSKIM    DATE: 2007/01/22 APPROVED BY: YS00KIM    DATE: 2007/01/22	TITLE	1.0 FFC BACKFLIP CONN. HOUSING ASSY 10P (BOTTOM CONTACT)	
			MATERIAL NO. SEE TABLE SIZE A3 THIS DRAWING CONTAINS INFORMATION THAT IS PROPRIETARY TO MOLEX INCORPORATED AND SHOULD NOT BE USED WITHOUT WRITTEN PERMISSION	MOLEX INCORPORATED DOCUMENT NO. SD-49456-001 SHEET NO. 2 OF 3		

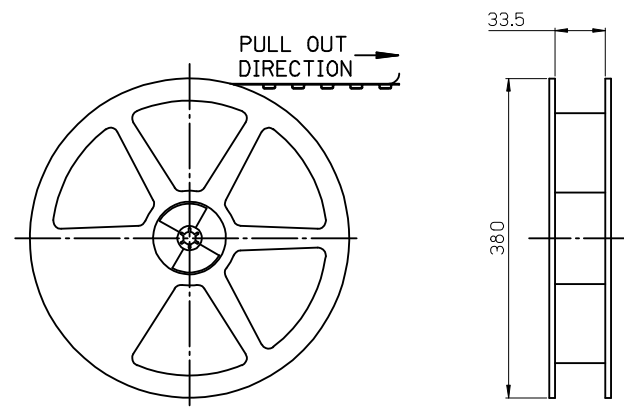
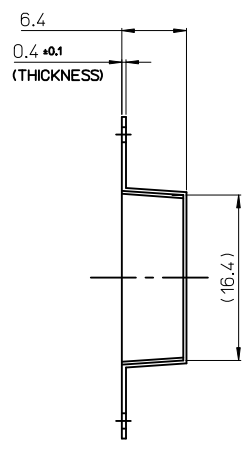
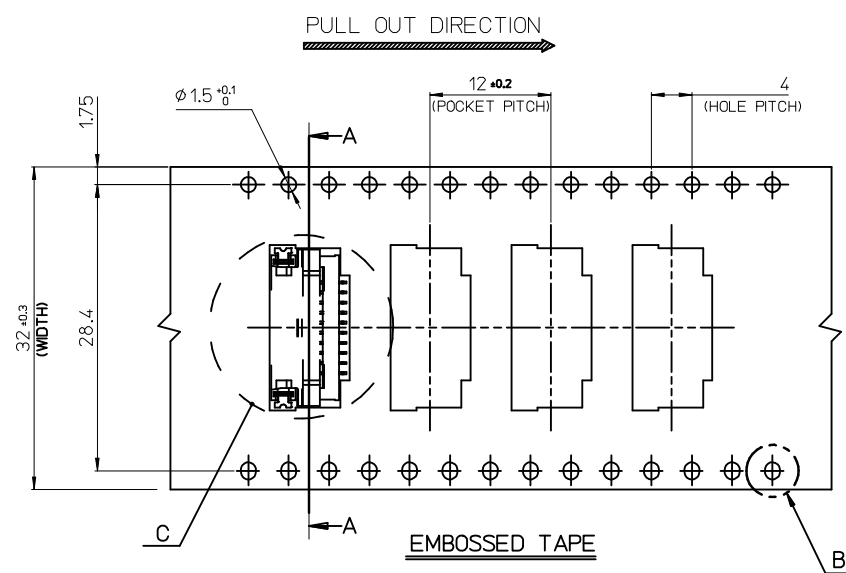

PLASTIC BOBBIN

NOTES

- 1. QUANTITY OF CONNECTORS : 1200PCS/REEL
- 2. LEAD LENGTH

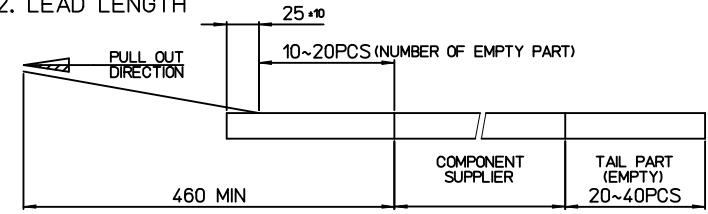

- 3. PEELING OFF FORCE OF COVER TAPE : 0.1N~0.59N(10.2GF~60GF)  
(PEELING DIRECTION AS SHOW IN FOLLOW FIG.)  
PEELING OFF SPEED : 300mm/Min.(Ref.)



- 4. FLASH IN ANY PORTION SHOULD BE LESS THAN 0.20mm MAX.

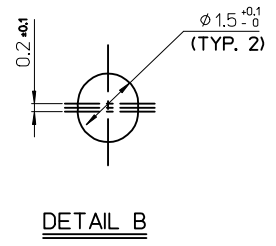
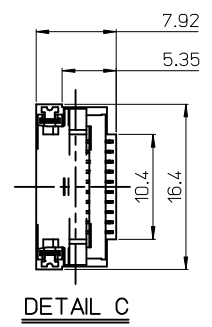

HALOGEN FREE	494561047	494561040	49456-9910	32mm
NON-HALOGEN FREE	494561017	494561010		
TYPE	MATERIAL NO.	CONNECTOR	EMBOSS TAPE	TAPE WIDTH
3	PLASTIC BOBBIN	HI P.S	WHITE	
2	COVER TAPE	P.E.T	25.5mm	
1	CARRIER (EMBOSS) TAPE	P.E.T	-	
NO.	DESCRIPTION	MATERIAL	REMARK	

REVISED  
 EC NO: KOR2017-0033  
 DRW: KYHWANG 2016/12/01  
 CHK: KSKIM 2016/12/01  
 APPR: YSKIM02 2016/12/05  
 B4

QUALITY SYMBOLS  
 ▽=0  
 ◻=0

GENERAL TOLERANCES (UNLESS SPECIFIED)	
mm	INCH
4 PLACES ± ---	± ---
3 PLACES ± ---	± ---
2 PLACES ± 0.25	± ---
1 PLACE ± 0.3	± ---
ANGULAR ± 1 °	
DRAFT WHERE APPLICABLE MUST REMAIN WITHIN DIMENSIONS	

DIMENSION STYLE	
MM ONLY	
DRAWN BY	DATE
JHLEE05	2007/01/22
CHECKED BY	DATE
KSKIM	2007/01/22
APPROVED BY	DATE
YSOOKIM	2007/01/22
MATERIAL NO.	
SEE TABLE	
SIZE	A3

SCALE	DESIGN UNITS	THIRD ANGLE PROJECTION
	METRIC	
TITLE		
1.0 FFC BACKFLIP CONN. HOUSING ASSY 10P (BOTTOM CONTACT)		
MOLEX INCORPORATED		
MATERIAL NO.	DOCUMENT NO.	SHEET NO.
SEE TABLE	SD-49456-001	3 OF 3
THIS DRAWING CONTAINS INFORMATION THAT IS PROPRIETARY TO MOLEX INCORPORATED AND SHOULD NOT BE USED WITHOUT WRITTEN PERMISSION		