

Features

- Stable and reliable performance
- Low profile, compact size
- SMT processes compatible
- RoHS Compliant

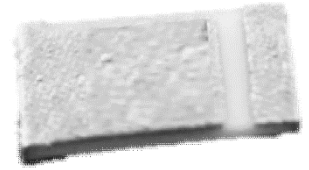

RoHS Compliant

includes all homogeneous materials
(see part numbering system for details)

Applications

- ISM 2.4 GHz applications
- ZigBee/BLE applications
- Bluetooth earphone system
- Hand-Held devices when WiFi / Bluetooth functions are needed, e.g., Smartphones
- Wireless PCMCIA cards or USB dongles

Specifications

PN: NAN-CB1B3216AF	
Electrical	
Frequency Range	2400~2500 MHz
Center Frequency	2442 MHz
Peak Gain	1.8 typ.
Efficiency	76.3 typ.
VSWR	2 Max
Polarization	Linear
Impedance	50Ω
Dimensions (mm):	
Body Length (A)	3.2 ± 0.15
Width (B)	1.6 ± 0.15
Thickness (C)	0.5 ± 0.15
Connection Type	SMT
Ground Plane	80 x 40 mm

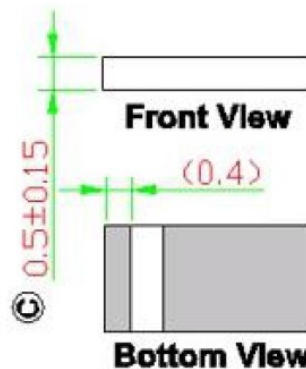
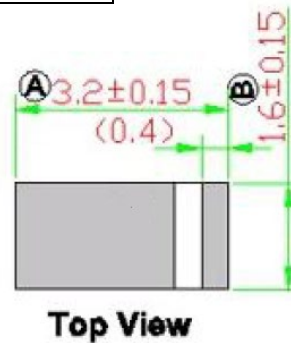
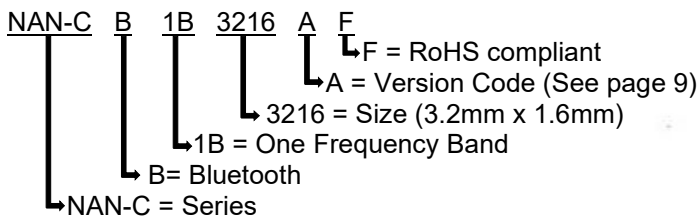

NOTE:
 1. All materials are RoHS 2.0 compliant.
 2. "A~C" Critical Dimensions.
 3. "()" Reference Dimensions.

Pin Definitions

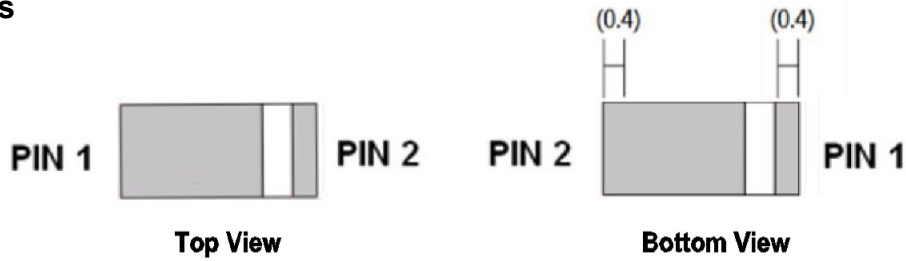

PIN	1	2
Soldering PAD	Signal	Tuning / Ground

Operating & Storage Conditions

Operating Conditions	
Maximum Input Power	2W
Humidity	-40°C to 85°C
Relative Humidity	10% to 70%
Storage (sealed)	
Storage Temperature	-5°C to 40°C
Relative Humidity	20% to 70%
Shelf Life	-35°C to 80°C
Storage (unsealed): Meet the criteria of J-STD-033 MSL2a	

Evaluation Board

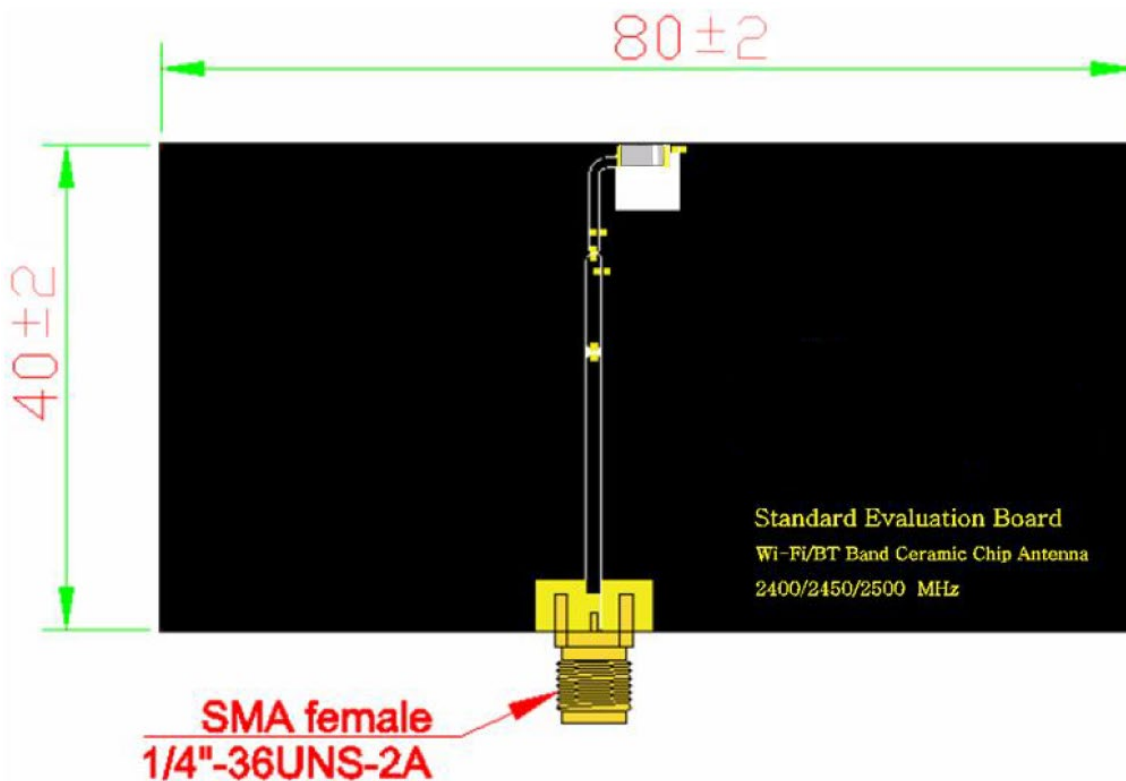

unit : mm

Solder Ground Pattern

The gold areas represent the solder land pattern. Any recommendations on the matching circuit will be provided according to the customer's installation conditions.

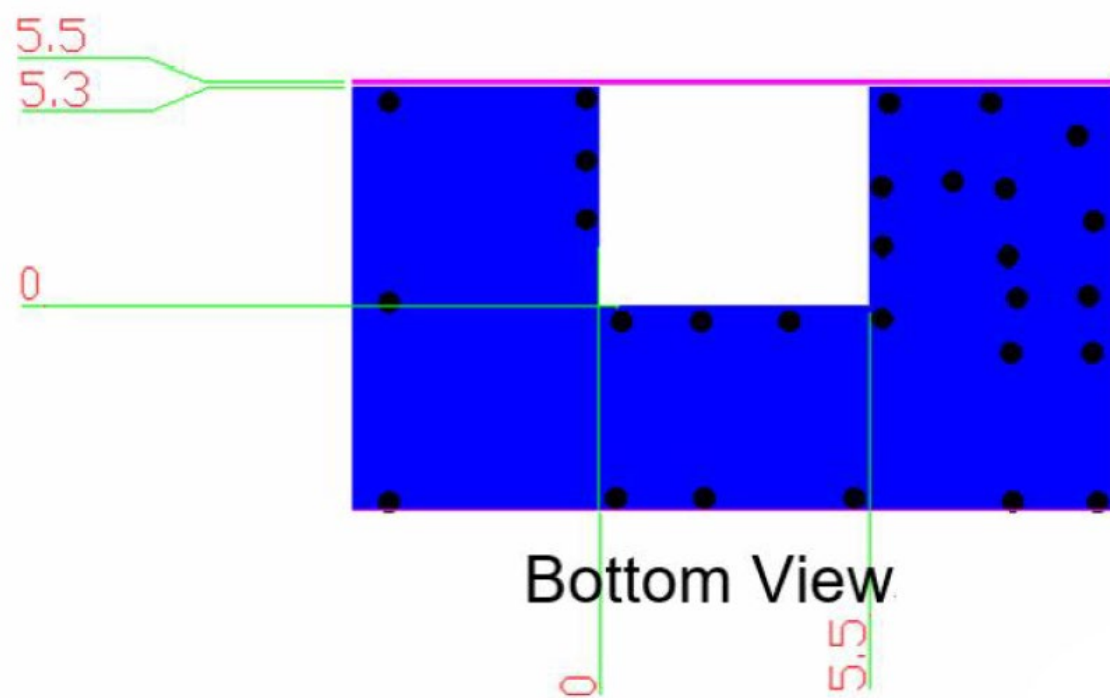
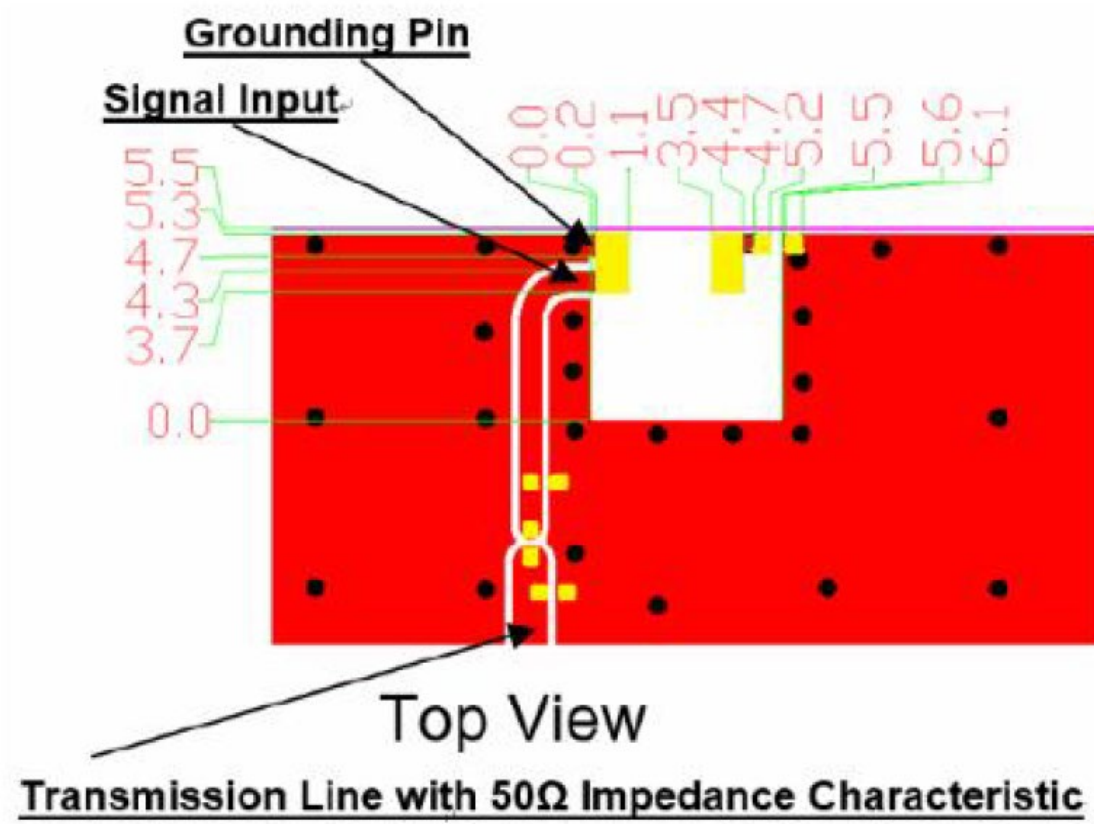

Soldering Conditions

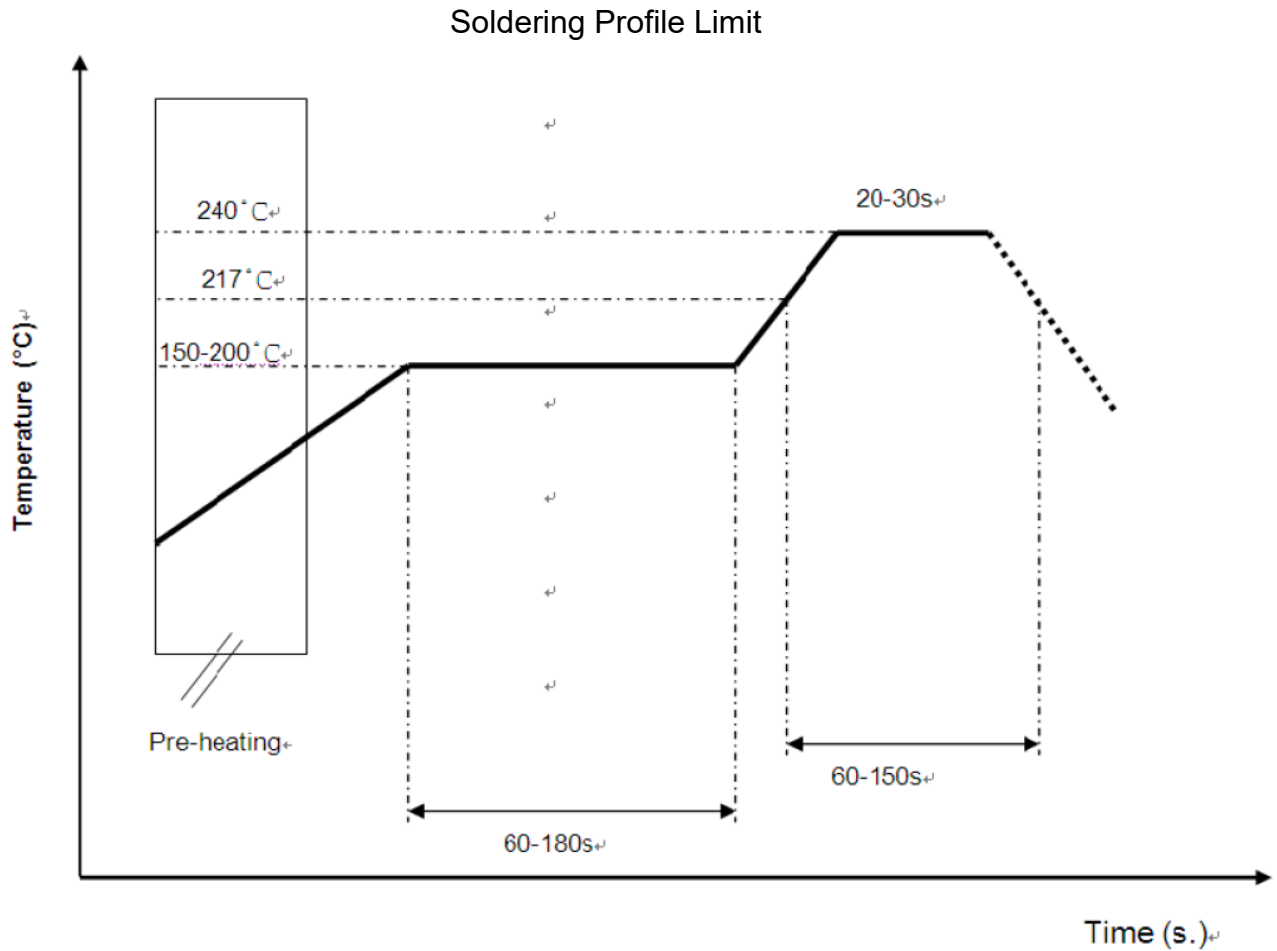

Frequency vs. VSWR and Total Radiation Gain

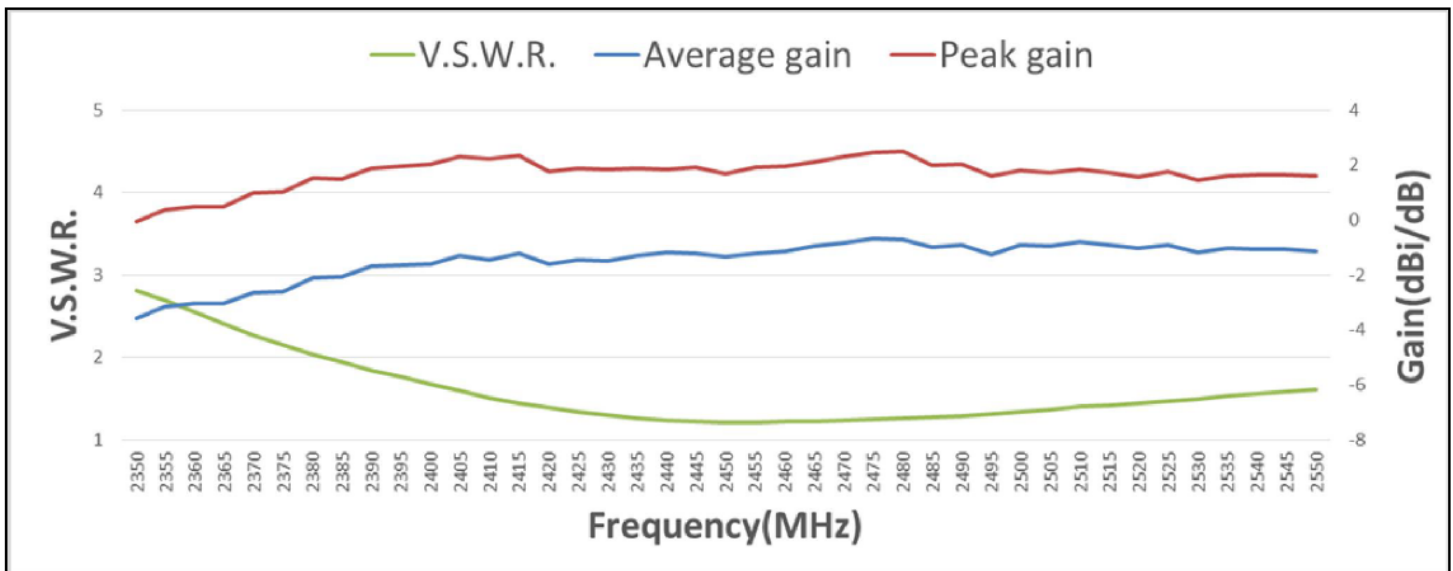

Radiation Patterns

3D Radiation Gain Pattern (with 80 x 40 mm Evaluation Board)

Gain Radiation Pattern @ 2442 MHz (unit: dBi)

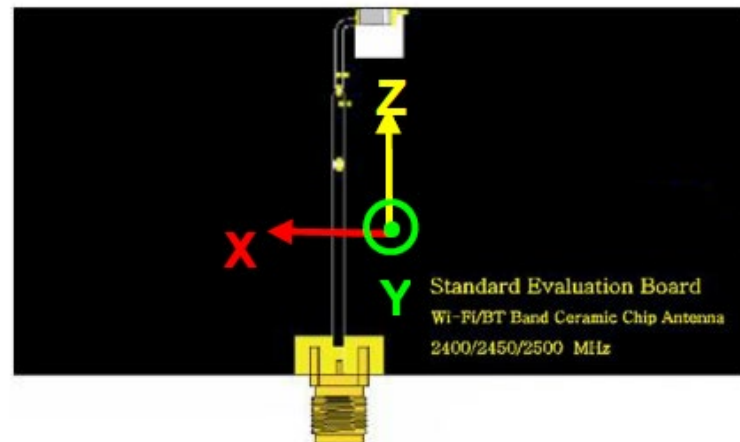
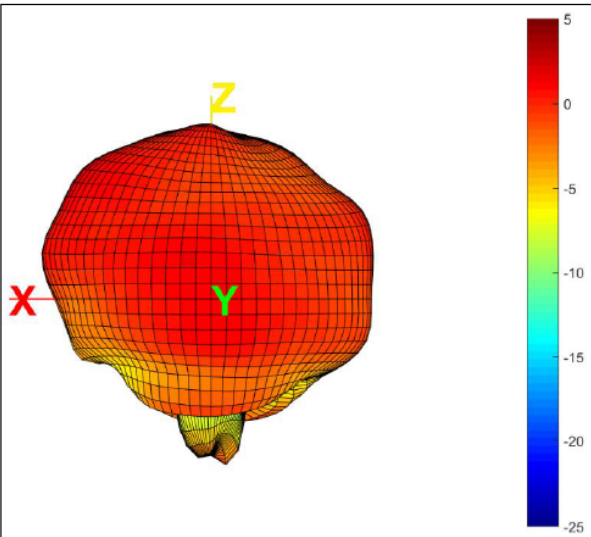
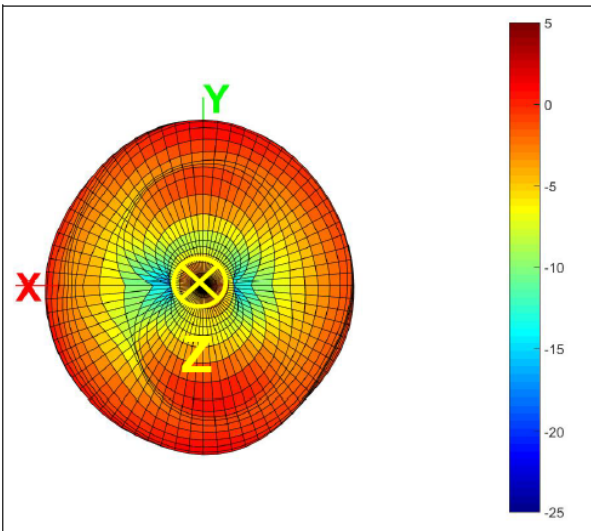
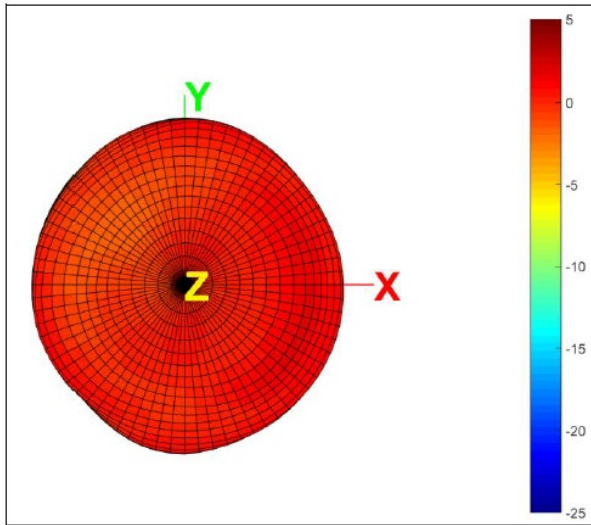

Frequency tuning and Matching circuit

Chip antenna tuning scenario :

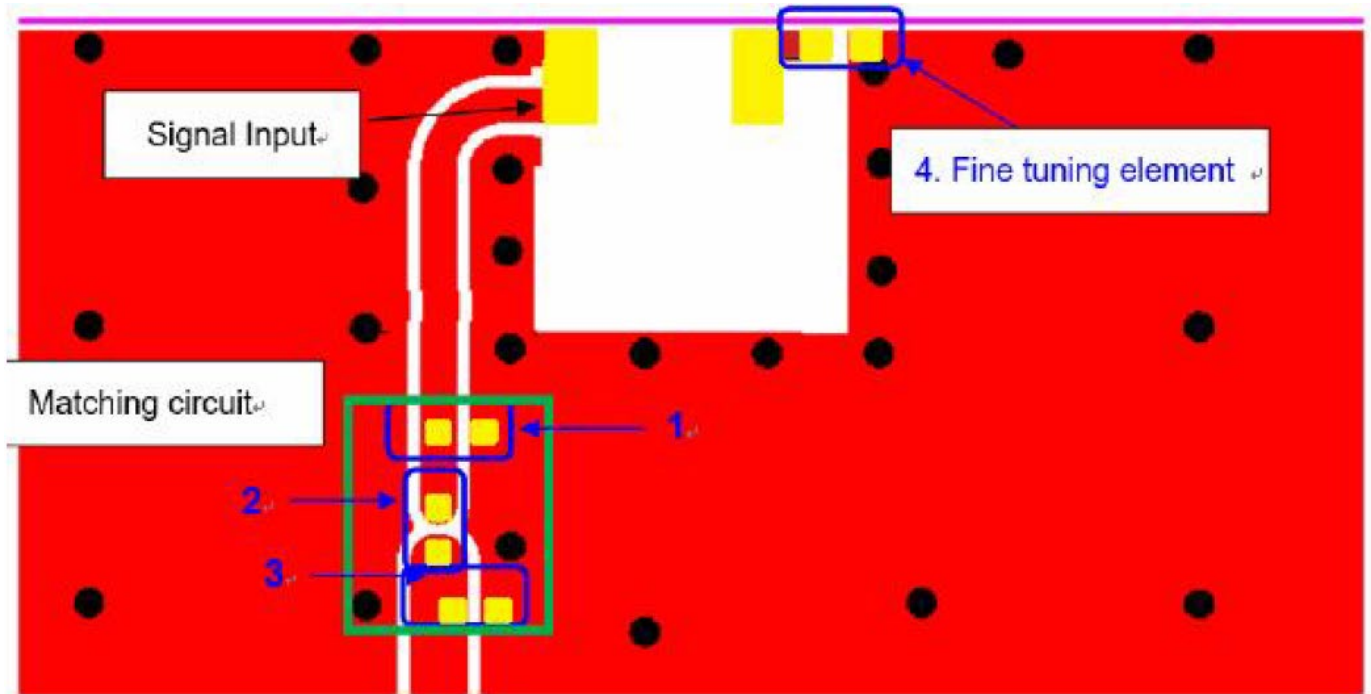

Matching circuit :

The center frequencies will be about 2442 MHz at our standard 80x40 mm evaluation board, with the following recommended values of matching and tuning components. *

* = These are typical reference values

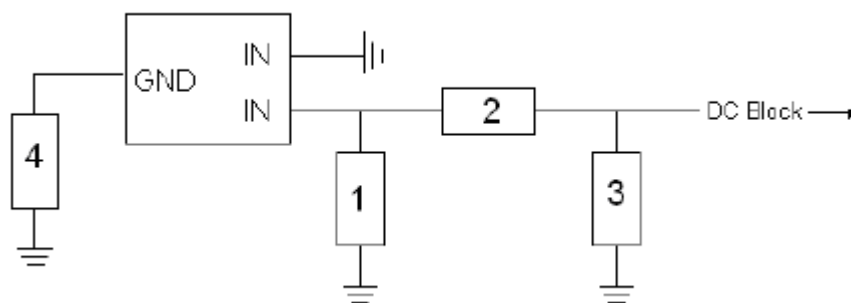

System Matching Circuit Component			
Location	Description	Tolerance	NIC Part Number
1	1.2 pF, (0402)	±0.05pF	NMC-Q0402NPO1R2A50TRPF
2	3.3nH, (0402)	±0.2nH	NIN-SK3N3CTR2000F
3	N/A	-	-
4	1.2 pF, (0402)	±0.05pF	NMC-Q0402NPO1R2A50TRPF

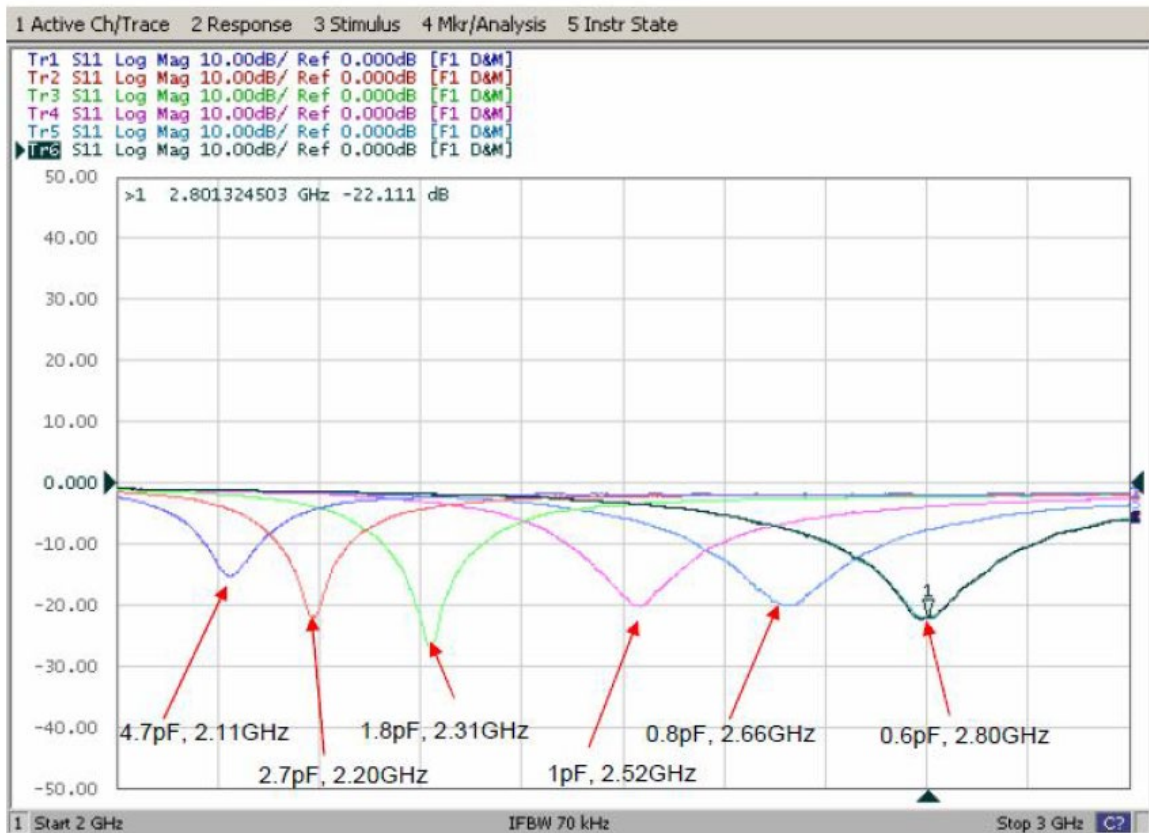
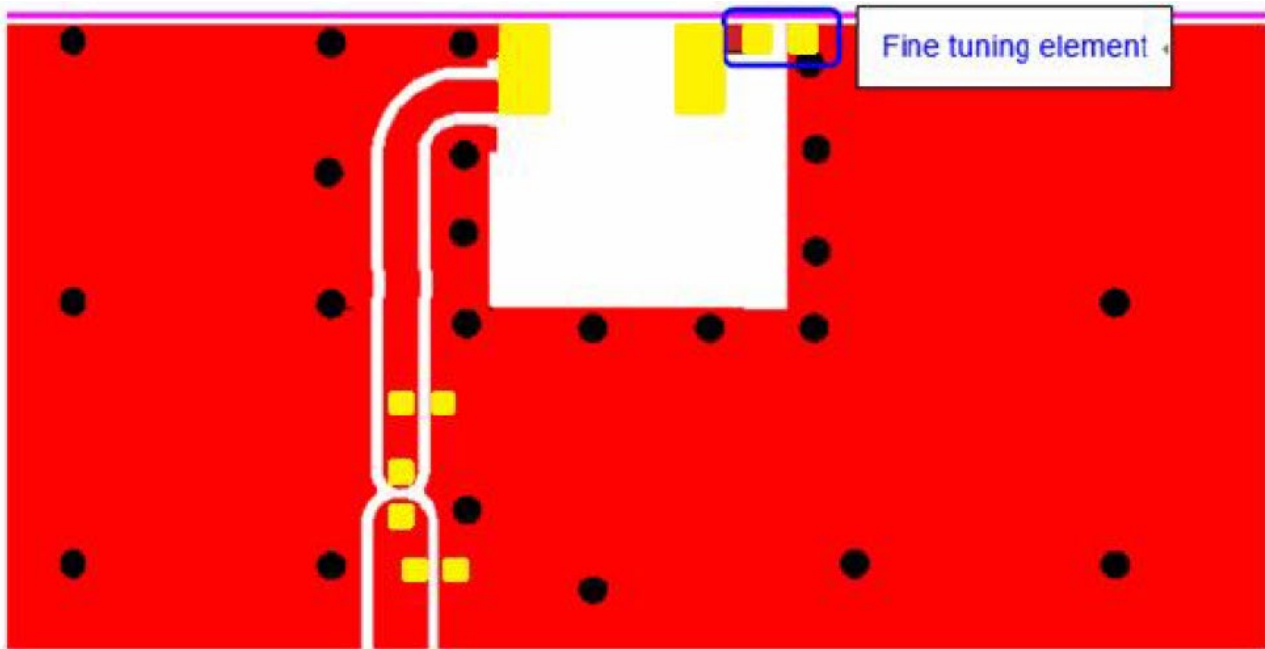

Packing

1. Quantity / Reel: 5000 pcs/Reel
2. Plastic tape: Black Conductive Polystyrene

a. Tape Drawing

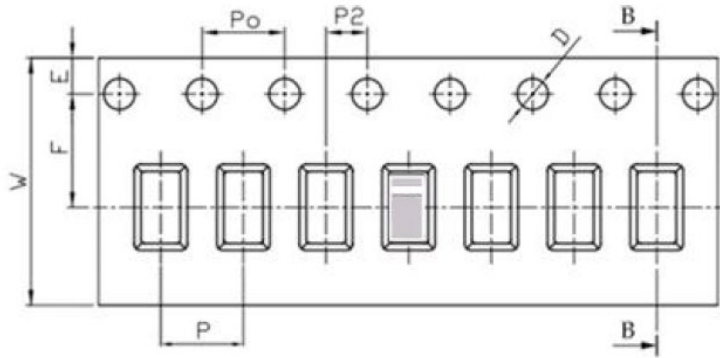

b. Tape Dimensions (unit: mm)

Feature	Specifications	Tolerances
W	12.00	±0.30
P	4.00	±0.10
E	1.75	±0.10
F	5.50	±0.10
P2	2.00	±0.10
D	1.50	+0.10 -0.00
Po	4.00	±0.10
10Po	40.00	±0.20

c. Reel Drawing

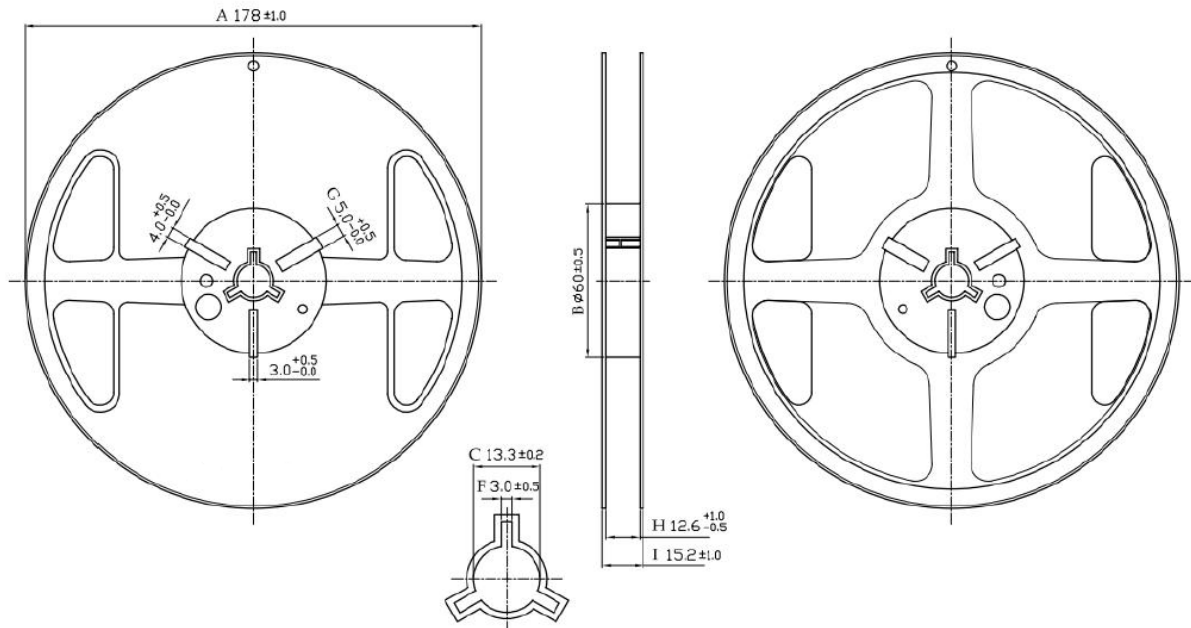

Version History and Status

Version	Date Issued	Details	Status
A	Dec 11 th , 2020	Initial Release	Supported
B	Jan 13 th , 2021	New Release: Higher Gain and Efficiency	Supported
C	May 5 th 2022	New Release: 40 x 40mm Ground Plane	Supported

Please reach out to NIC for any customization requests and other inquiries:

- NIC Technical Support: tpmg@niccomp.com
- Compliance Support: rohs@niccomp.com