

Product Name: PB25D8 Castle Patch Antenna

Part Number: H2P13ABB110100

Features:

- Supporting: (L1+L5) GPS/ BDS/Galileo/QZSS/IRNSS
- Dimensions: 25 x 25 x 4.5 mm
- Stable and reliable in performances
- Low temperature coefficient of frequency
- RoHS 2.0 compliance

Applications:

- Automotive telematics
- Safety of life transportation
- Marine
- Navigation

Castle Patch Antenna

MODEL: PB25D8

Version: B

I. Patch Antenna Specifications:

Items	Specifications	
Navigation	GPS L1/ Galileo E1/ BDS B1/ QZSS L1	GPS L5 Galileo E5a/ BDS B2/ QZSS L5 IRNSS L5
Center Frequency (MHz)	1575.42	1176.5
Return loss (dB)	< -10 Typ.	
Peak Gain (dBi)	5 Typ.	3 Typ.
Axial Ratio (dB)	<3 Typ.	
Average Gain(dB)	-2.2 Typ.	-3.2 Typ.
Efficiency (%)	60 Typ.	48 Typ.
Test Condition	100 x 100 mm ² (Evaluation board)	
Impedance (Ω)	50	
Polarization	RHCP	

Mechanical Specifications	
Dimensions (mm)	25(L) x 25 (W) x4.5 (H)
Material	Ceramic
Environmental Conditions	
Operation Temperature (°C)	-40 ~ +85
Storage Temperature (°C)	-5 ~ +40
Relative Humidity	10 ~ 70 %

© Unictron Technologies Corp.
All specifications subject to change without notice.

II. Antenna Dimensions (unit: mm):

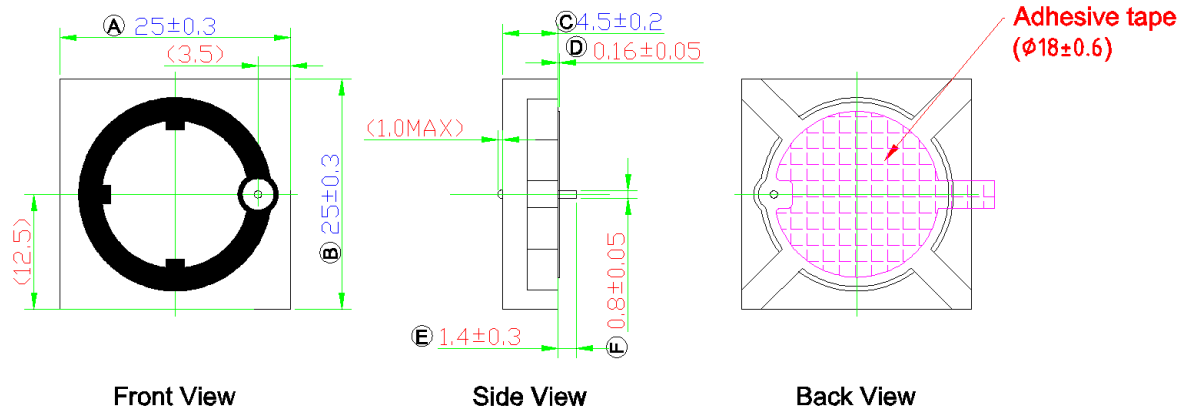

© Unictron Technologies Corp.
All specifications subject to change without notice.

NOTE:

1. All materials are RoHS 2.0 compliant.
2. "A~F" Critical Dimensions.
3. "()" Reference Dimensions.

III. Block Diagram

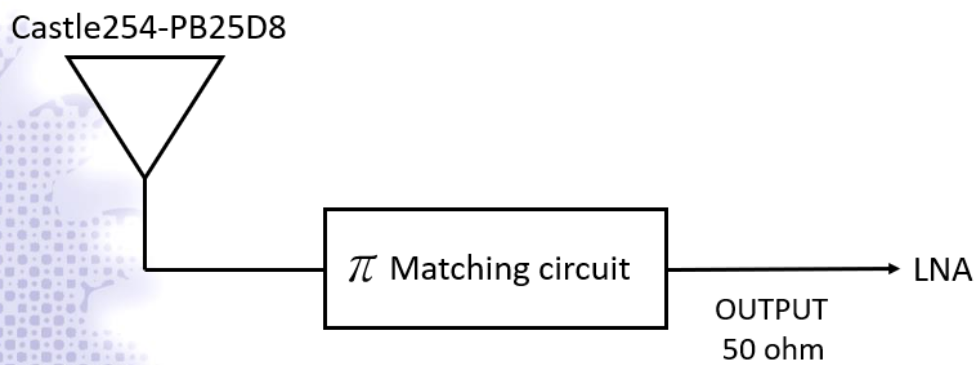

IV. Matching circuit

With the following recommended values of matching and tuning components, at our standard 100 x 100 mm² evaluation board. However, these are typical reference values which may need to be changed when circuit boards or part vendors are different.

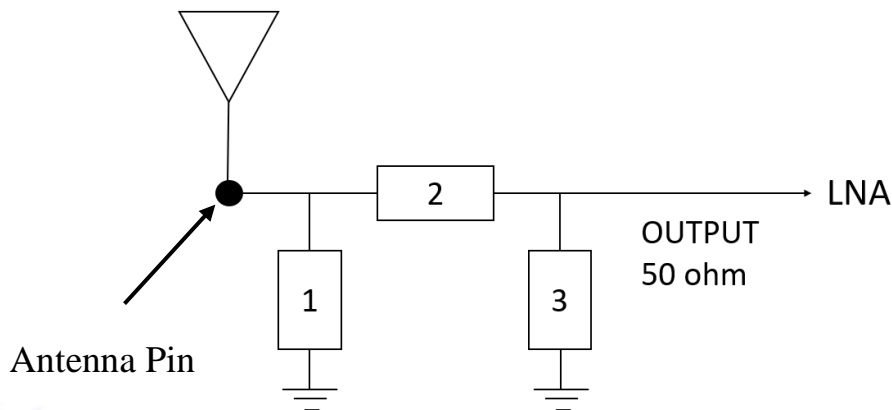
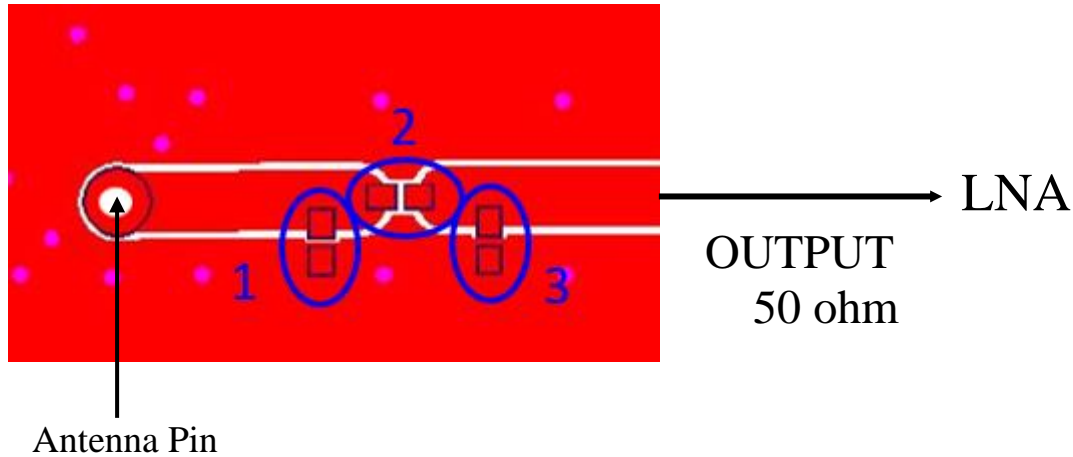

System Matching Circuit Component			
Location	Description	Vendor	Tolerance
1	4.7nH (0402)	MURATA	±0.1nH -
2	0Ω, (0402)	-	-
3	N/A	-	-

© Unictron Technologies Corp.
All specifications subject to change without notice.

V. Properties:

a) Return loss (dB)

I. GNSS L1 Band

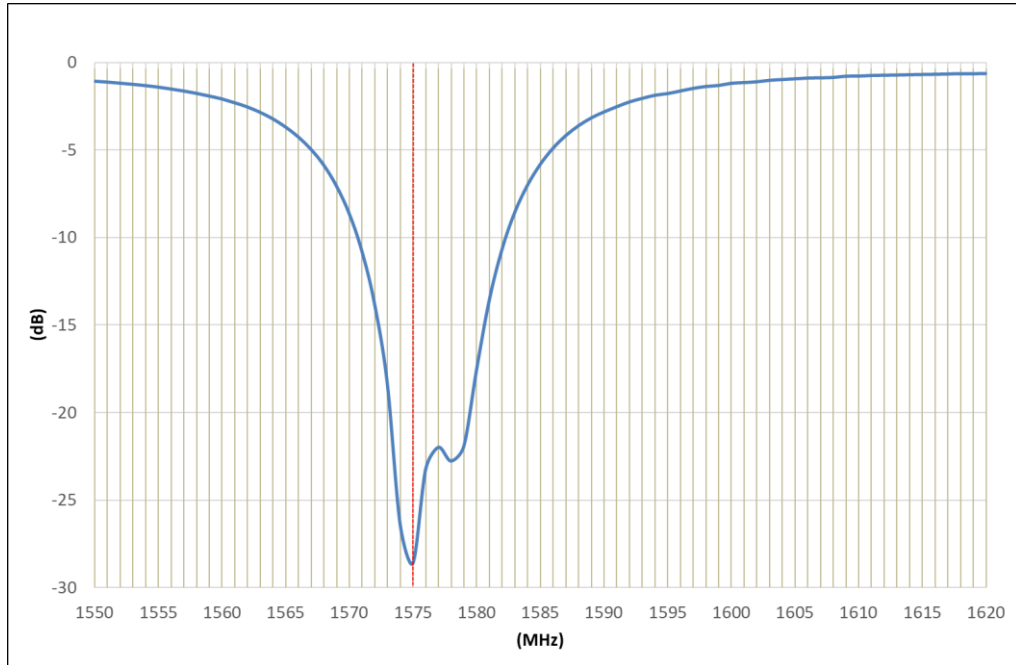

II. GNSS L5 Band

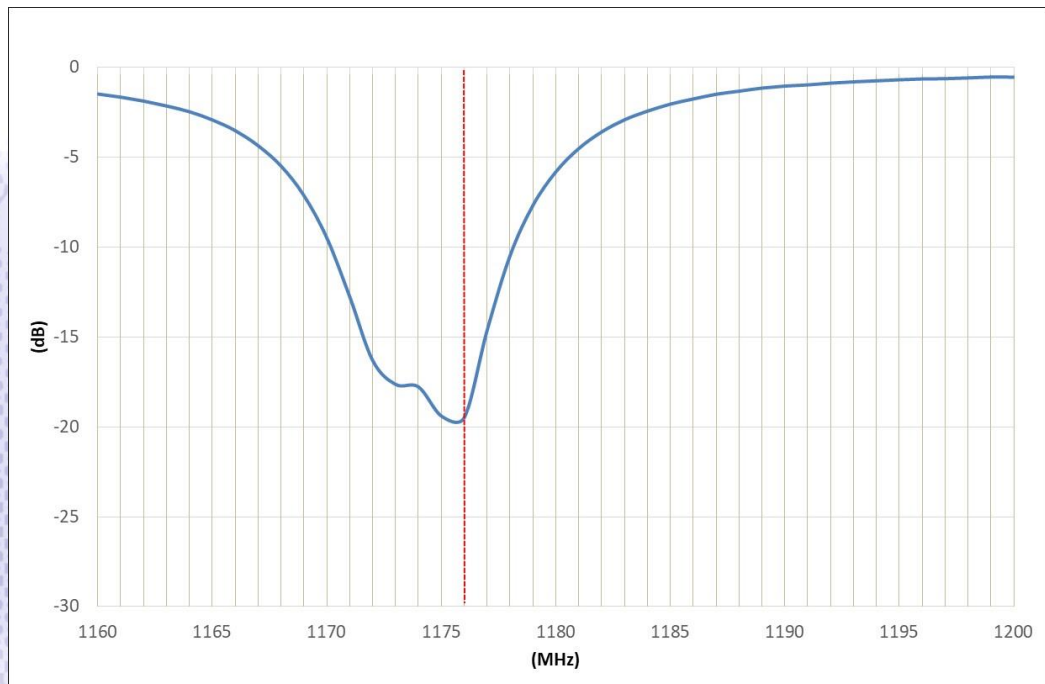

© Unictron Technologies Corp.
All specifications subject to change without notice.

b) Peak Gain (dBi)

I. GNSS L1 Band

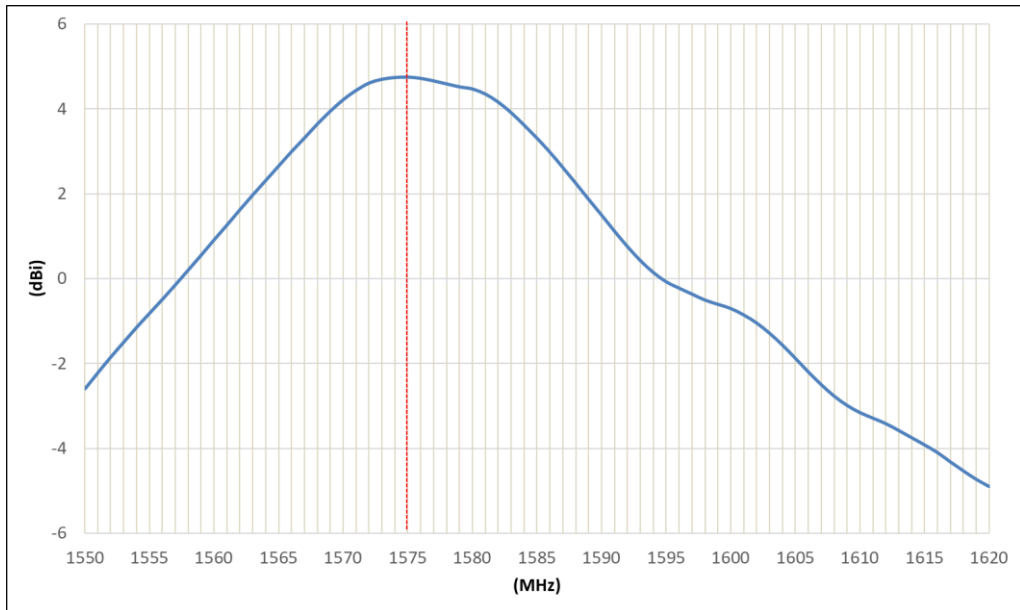

II. GNSS L5 Band

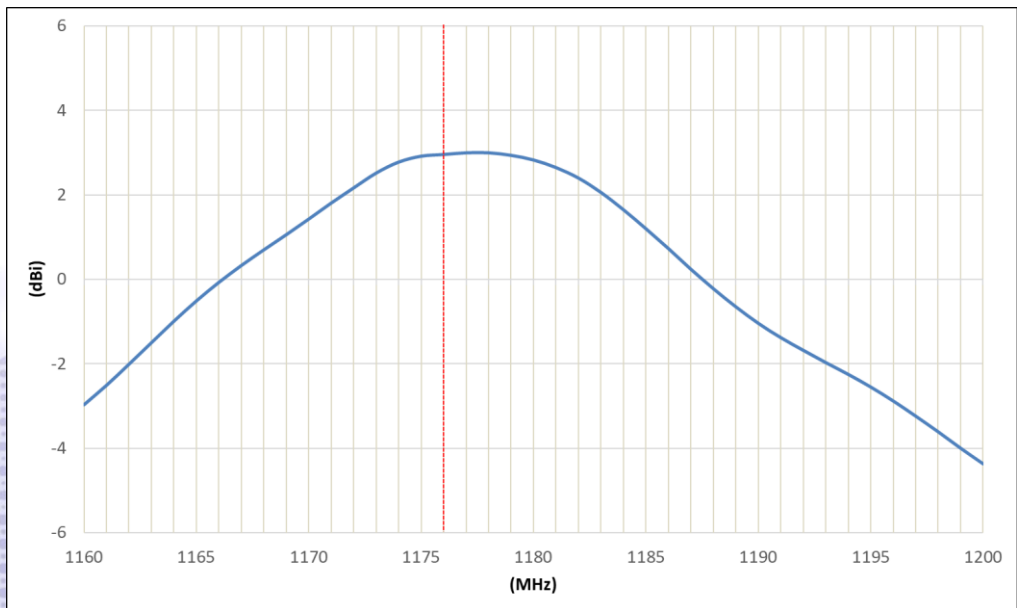

© Unictron Technologies Corp.
All specifications subject to change without notice.

c) Axial Ratio (dB)

I. GNSS L1 Band



II. GNSS L5 Band

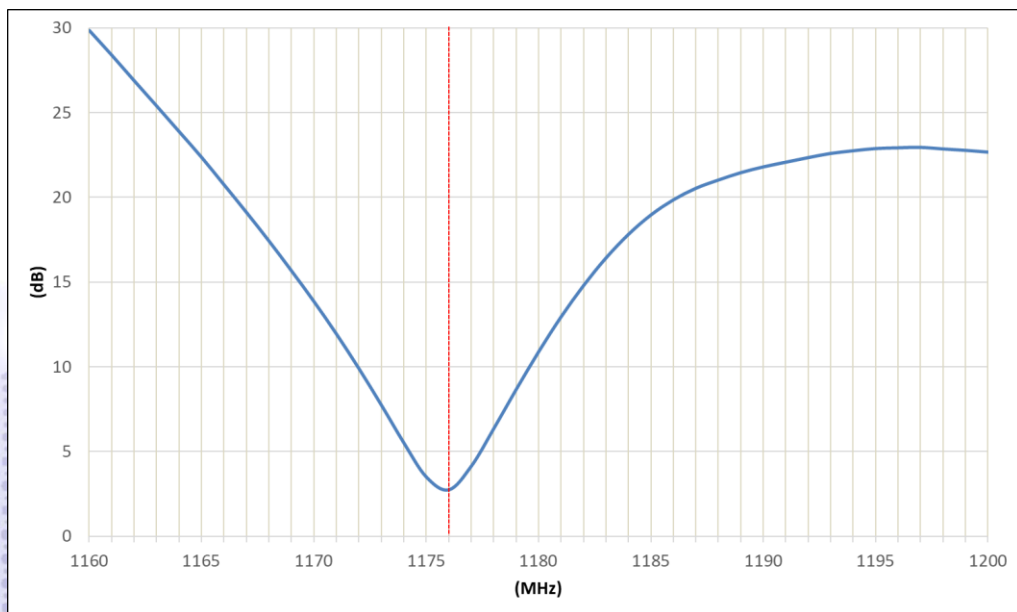

© Unictron Technologies Corp.
All specifications subject to change without notice.

d) Average Gain(dB)

I. GNSS L1 Band

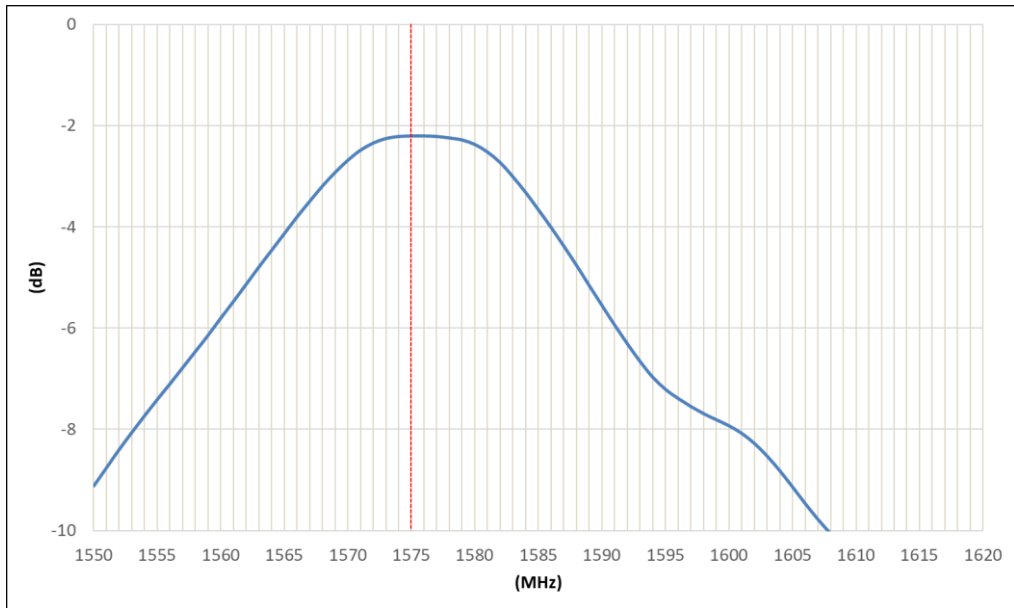

II. GNSS L5 Band

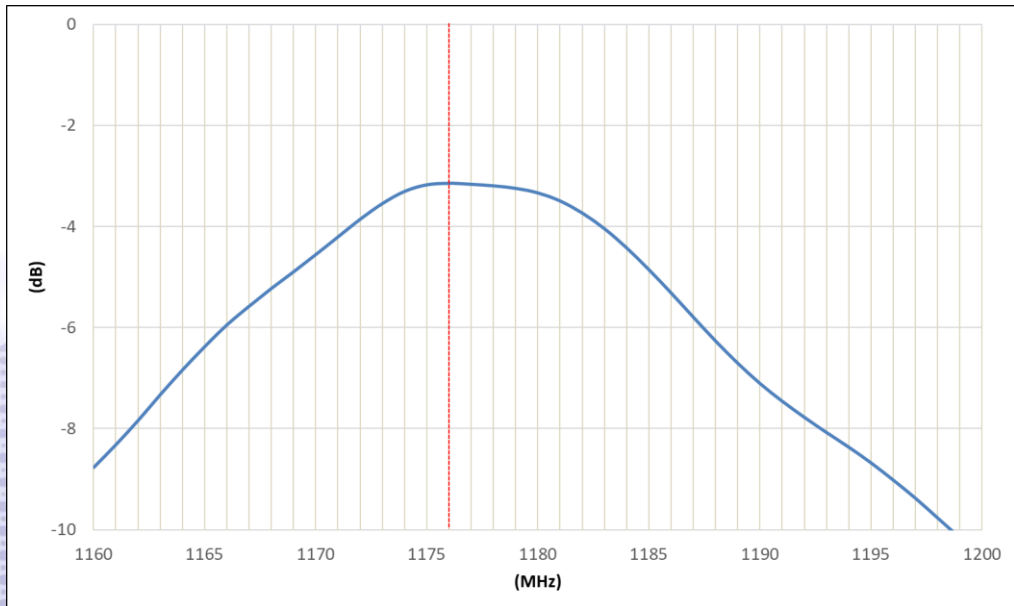

© Unictron Technologies Corp.
All specifications subject to change without notice.

e) Efficiency (%)

I. GNSS L1 Band

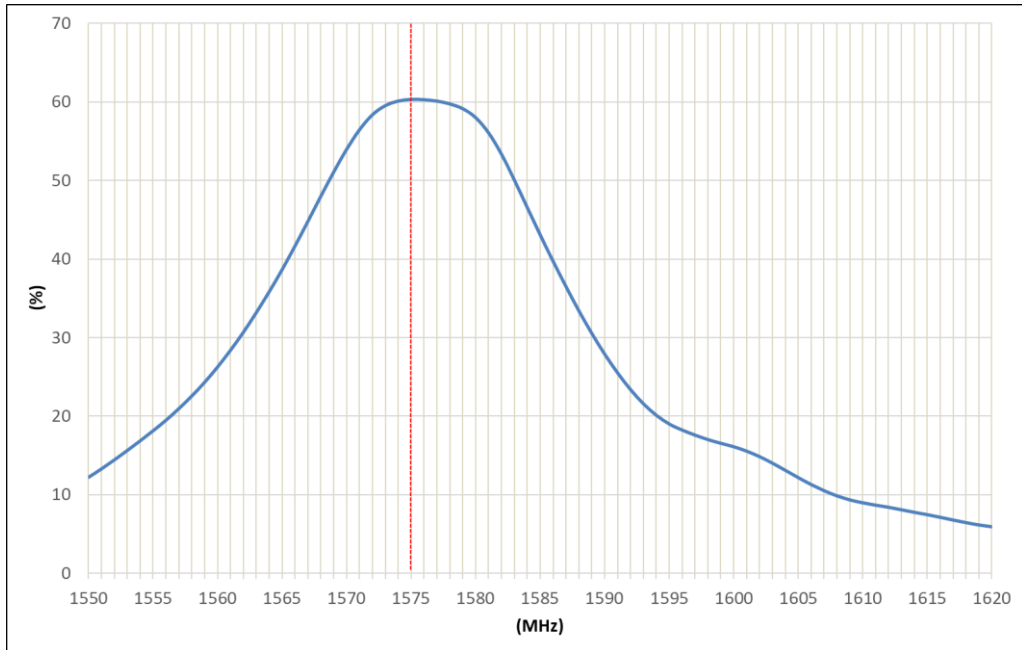

II. GNSS L5 Band

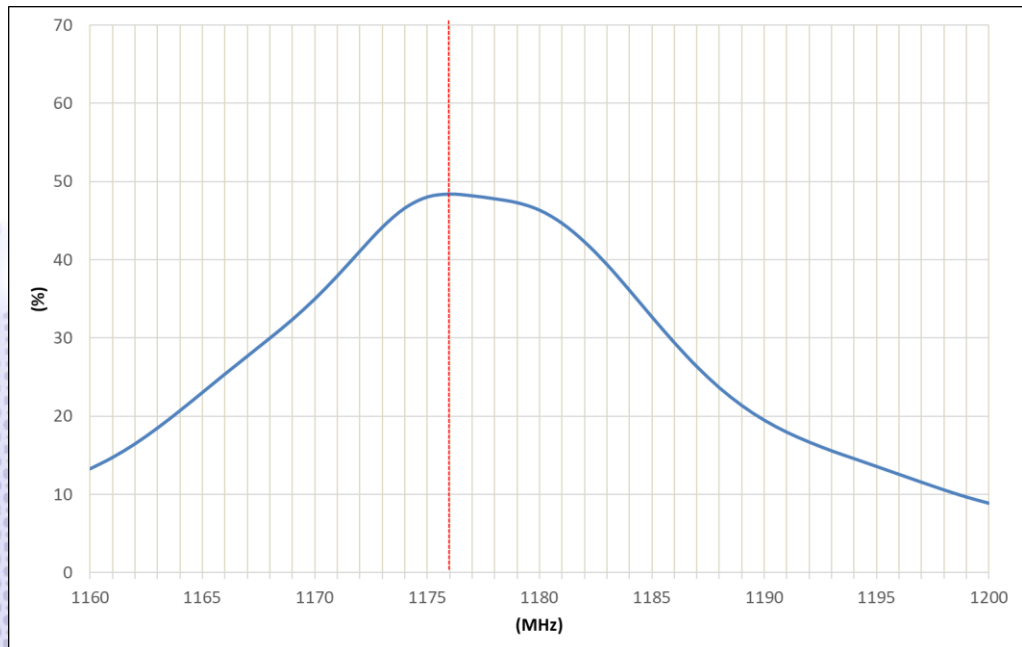

© Unictron Technologies Corp.
All specifications subject to change without notice.

VI. Antenna Radiation Pattern Measurement:

The antenna radiation patterns are measured in Unictron's 3D Anechoic Chamber. The measurement setup is as show below.

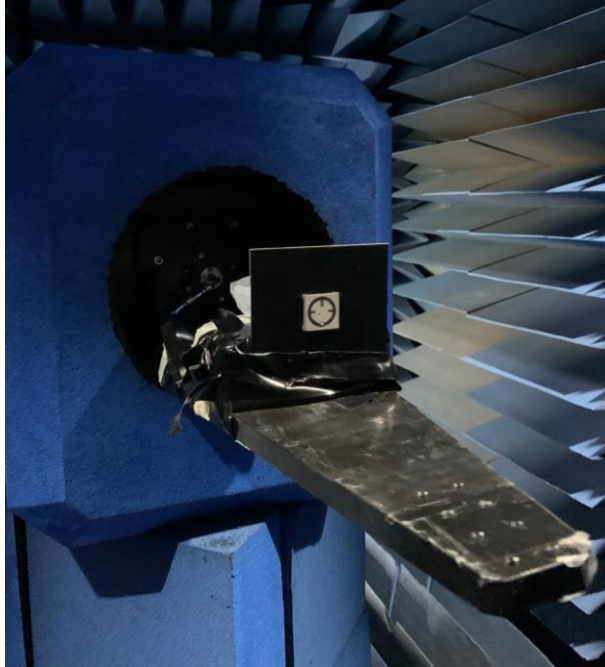

© Unictron Technologies Corp.
All specifications subject to change without notice.

2D Radiation Gain Pattern

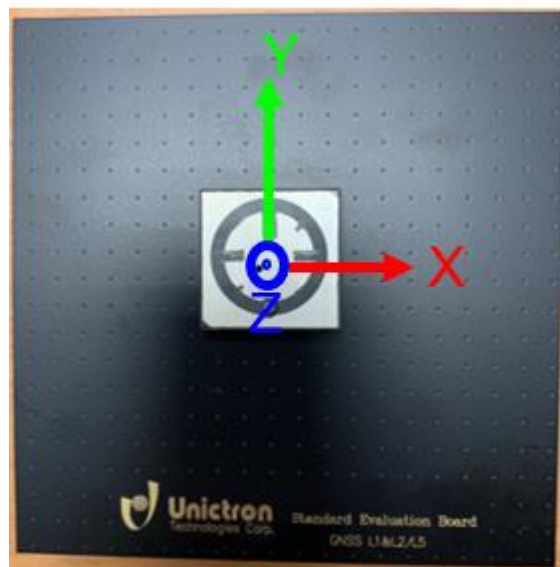

a) GNSS L1 Band @1575.42MHz (unit: dBi)

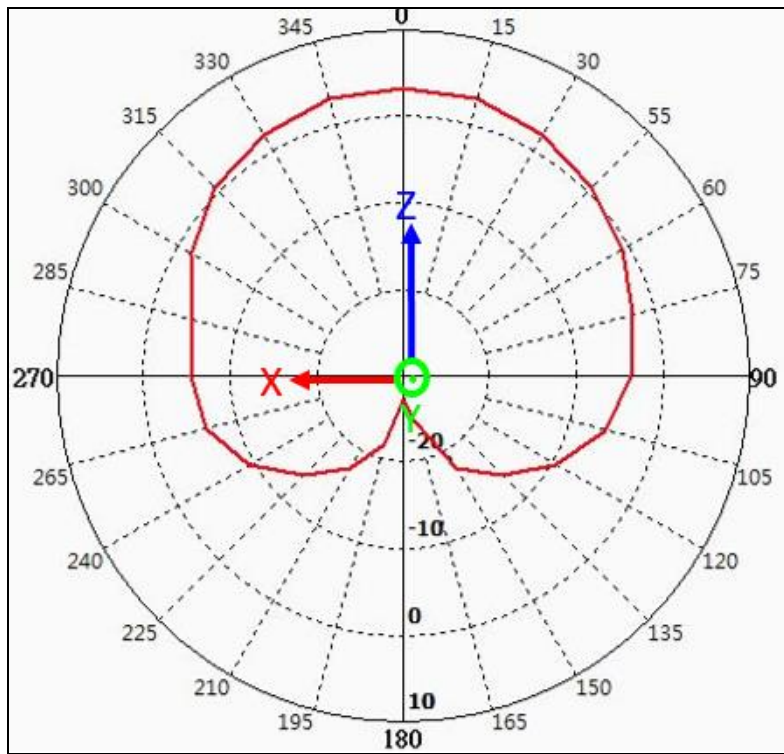

b) GNSS L5 Band @1176.5MHz (unit: dBi)

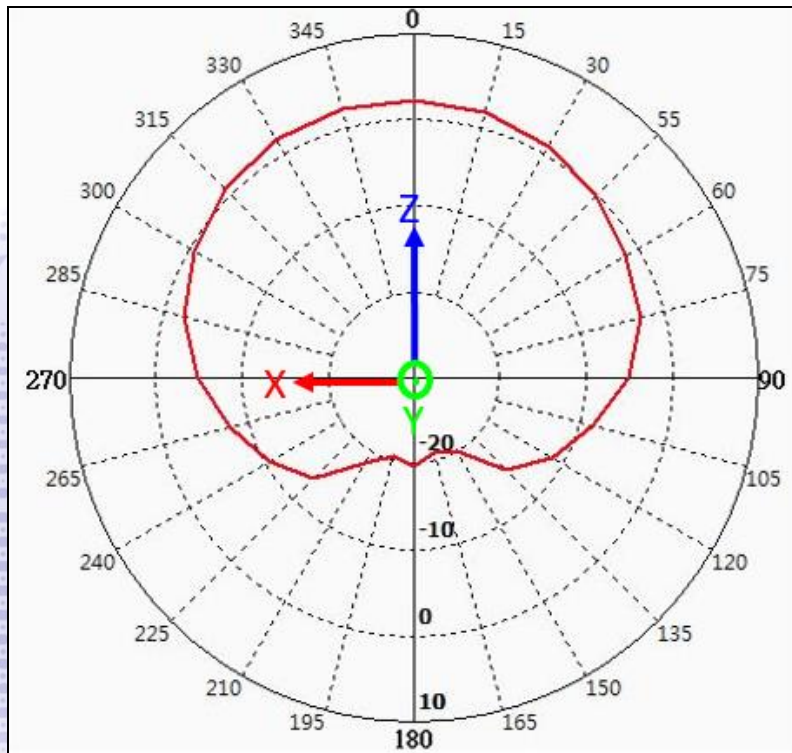

© Unictron Technologies Corp.
All specifications subject to change without notice.

VII. Packing:

a) Weight:



Unit Weight: 9.4 ± 0.5 (g)

b) Quantity:

Each Vacuum Bag: 250 pcs

Each Outer Box: 500 pcs

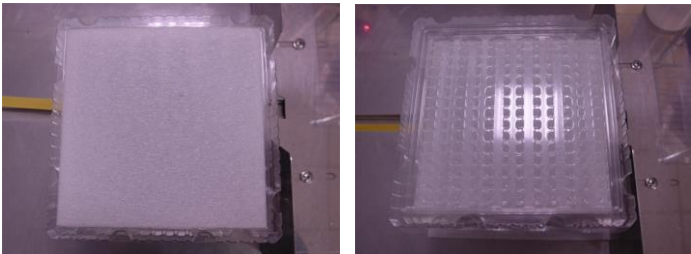
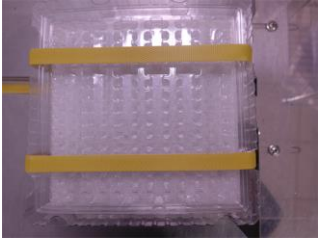
© Unictron Technologies Corp.
All specifications subject to change without notice.

Step	Pictures	Descriptions
1		<p>Place five trays into one stack. Once stacked, place a sheet of EPE in the depression on the top tray, and then another tray on top. Place another sheet of EPE beneath the bottom tray to complete the stack. Make sure the trays and the EPE sheets are lined up correctly.</p>
2		<p>Place the stacked trays on the packaging machine to be tape punched and tightly secured.</p>
3		<p>Place the stacked trays into a vacuum bag to be vacuum sealed, and then labeled.</p>
4		<p>Place two vacuum bags vertically into a carton and then seal the carton.</p>