

# 5V/9V/12V@2.4A Output QC2.0 Car Charger Solution Application Report

## ACT4526

## FEATURES

- Wide input voltage range from 6V to 32V
- Transparent input voltage surge up to 40V
- QC2.0 decoding, 5V/9V/12V output voltage regulation
- 2.4A output with Constant current regulation
- 125kHz switching frequency
- Low standby input current <1mA
- Good EMC performance
- Under voltage protection at output short
- <6mA average output current at output short
- Output over voltage protection
- Output cord compensation
- Thermal shutdown protection

## SPECIFICATION

DESCRIPTION	CONDITION	MIN	TYP	MAX	UNITS
Output current limit range		2400	2650	2900	mA
Ripple Voltage	Vin=12V,output 5V/2.4A		46		mVpp
	Vin=12V,output 9V/2.4A		27		
	Vin=12V,output 11.6V/2.4A		19		
	Vin=24V,output 5V/2.4A		59		
	Vin=24V,output 9V/2.4A		72		
	Vin=24V,output 12V/2.4A		80		
Efficiency at full load	Vin=12V,output 5V/2.4A		89.6		%
	Vin=12V,output 9V/2.4A		94.9		
	Vin=12V,output 12V/2.4A		96.7		
	Vin=24V,output 5V/2.4A		87.7		
	Vin=24V,output 9V/2.4A		92.4		
	Vin=24V,output 12V/2.4A		93.9		
<b>ENVIRONMENTAL</b>					
ESD	Contact		8		kV
	Through air		15		kV

**TABLE OF CONTENTS**

1. Demo Board Photo .....	3
2. PCB Layout .....	3
3. Schematic.....	3
4. Bill of Materials.....	4
5. Functional Test.....	5
5.1. Output Regulation (on PCB board) .....	5
5.2. Efficiency (Ta=25°C).....	6
5.3. Power Loss .....	7
5.4. Constant Current and Constant Voltage (Ta=25°C).....	9
5.5. Standby Input Current .....	12
5.6. Ripple and Noise .....	13
5.7. Load Dynamic Response .....	15
5.8. Output Voltage Transient .....	16
5.9. Line Dynamic Response(Vin change from 12V to 40V, 0.1V/us).....	17
5.10. Key Components Temperature Test ( burning for 2 hours) .....	18
6. EMI TEST.....	19
6.1. Output=5V .....	19
6.2. Output=9V .....	20

## 1. DEMO BOARD PHOTO

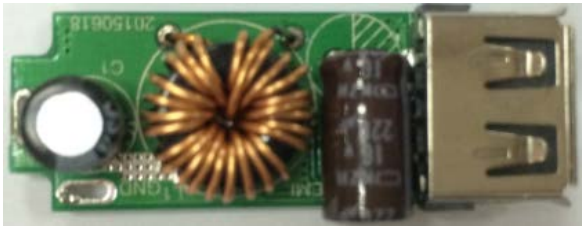

## 2. PCB LAYOUT

PCB SIZE: 39.4mm\*15.0mm

TOP LAYER

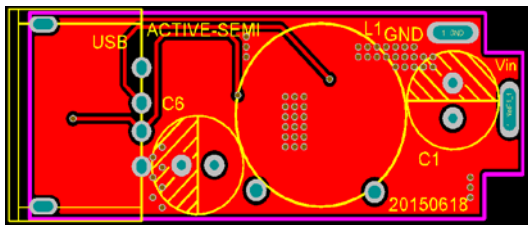

BOTTOM LAYER

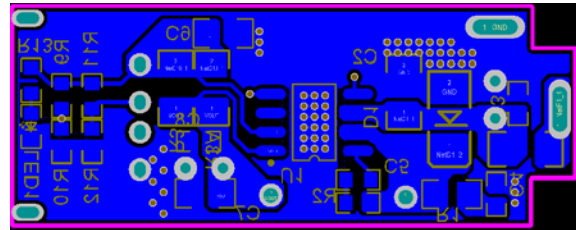

## 3. SCHEMATIC

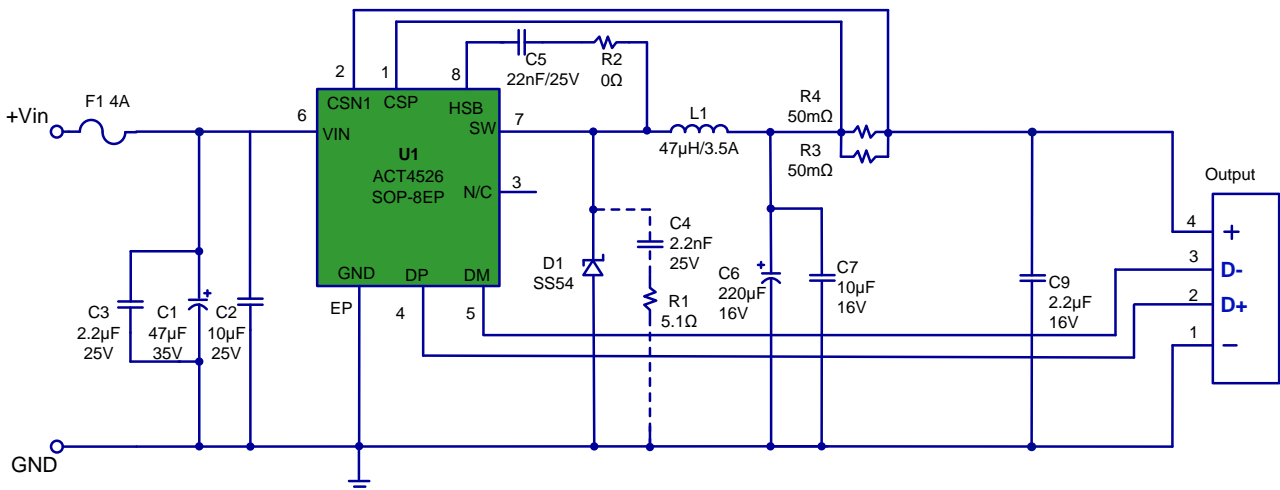

#### 4. BILL OF MATERIALS

Item	Reference	Description	QTY	Manuf.
1	L1	Choke Coil, Dip,T9*5*4mm, phi=0.6mm, L=47uH	1	
2	D1	Schottky Diode, SK54BL, 40V/5A, SMB	1	Panjit
3	C1	Electrolytic capacitor, 47uF/35V, 6.3x8mm	1	Koshin
4	C2	Ceramic capacitor, 10uF/35V, X7R, 1206	1	Murata/TDK
5	C3	Ceramic capacitor, 2.2uF/35V, X7R, 0805	1	Murata/TDK
6	C4	Ceramic capacitor, 2.2nF/25V, X7R, 0603(optional)	1	Murata/TDK
7	C5	Ceramic capacitor, 22nF/25V, X7R, 0603	1	Murata/TDK
8	C6	Electrolytic capacitor, 220uF/16V, 7x11.5mm	1	Koshin
9	C7	Ceramic capacitor, 10uF/16V, X7R, 0805	1	Murata/TDK
10	C9	Ceramic capacitor, 2.2uF/16V, X7R, 0603	1	Murata/TDK
11	F1	Fuse, 3A, 1206 ( Replaced by 0Ω 0805 chip resistor )	1	Murata/TDK
12	R1	Chip Resistor, 5.1Ω, 1/8W, 5%, 0805(optional)	1	Murata/TDK
13	R2	Chip Resistor, 0Ω, 1/10W, 5%, 0603	1	Murata/TDK
14	R3/R4	Chip Resistor, 50mΩ, 1/4W, 1%, 1206	2	Murata/TDK
15	U1	IC, ACT4526, SOP-8-EP	1	ACT
16	USB	USB Rev: A	1	

## 5. FUNCTIONAL TEST

### 5.1. Output Regulation (on PCB board)

Vout=5V (With cord compensation)

VIN	Minimum Output Voltage(V)	Maximum Output Voltage(V)	Load Regulation	Iload
10V	5.09	5.22	2.5%	0A-2.4A
12V	5.09	5.22	2.5%	
16V	5.09	5.22	2.5%	
24V	5.09	5.022	2.5%	

Vout=9V(With cord compensation)

VIN	Minimum Output Voltage(V)	Maximum Output Voltage(V)	Load Regulation	Iload
10V	9.21	9.34	1.4%	0A-2.4A
12V	9.21	9.21	1.4%	
16V	9.21	9.34	1.4%	
24V	9.21	9.34	1.4%	

Vout=12V(With cord compensation)

VIN	Minimum Output Voltage(V)	Maximum Output Voltage(V)	Load Regulation	Iload
10V	9.61	10.05	4.5%	0A-2.4A
12V	11.56	11.91	3.0%	
16V	12.19	12.32	1.1%	
24V	12.19	12.32	1.1%	

5.2. Efficiency (Ta=25°C)

VIN	Vout=5V Efficiency (%)				
	Io=100mA	Io=1000mA	Io=1500mA	Io=2000mA	Io=2400mA
10V	88.94	93.12	92.14	91.15	90.04
12V	86.30	92.11	91.46	90.43	89.55
16V	83.16	90.69	90.43	89.44	88.96
24V	75.49	88.72	88.70	88.44	87.73

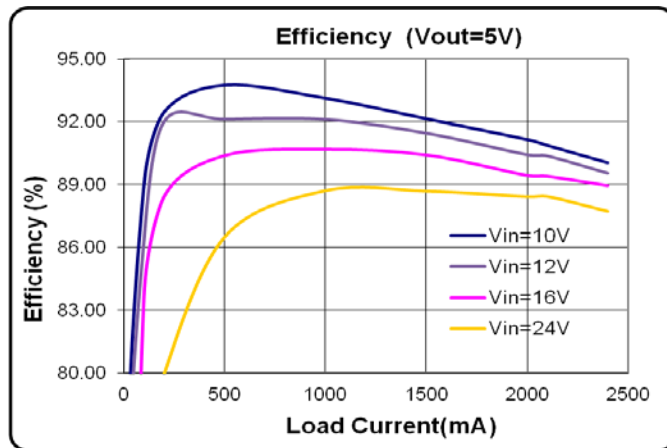

VIN	Vout=9V Efficiency (%)				
	Io=100mA	Io=1000mA	Io=1500mA	Io=2000mA	Io=2400mA
10V	94.72	97.48	96.83	96.25	95.39
12V	93.70	96.68	96.15	95.43	94.91
16V	89.93	94.88	94.55	93.89	93.56
24V	89.23	92.80	92.89	92.68	92.39

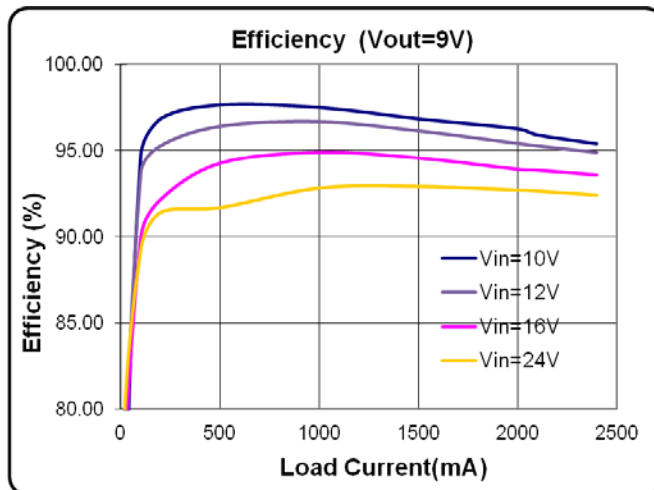

VIN	Vout=12V Efficiency (%)				
	Io=100mA	Io=1000mA	Io=1500mA	Io=2000mA	Io=2400mA
12V	97.94	98.31	97.73	97.11	96.66
16V	92.91	96.72	96.34	95.97	95.60
24V	90.74	94.33	94.52	94.30	93.90

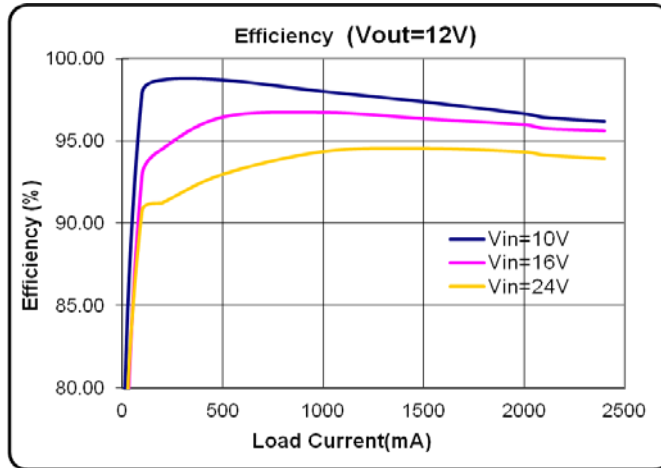

### 5.3. Power Loss

Vin	Vout=5V Power loss (W)					
	Io=0mA	Io=100mA	Io=1000mA	Io=1500mA	Io=2000mA	Io=2400mA
Vin=10V	0.01	0.06	0.38	0.66	1.01	1.39
Vin=12V	0.01	0.08	0.44	0.72	1.1	1.46
Vin=16V	0.02	0.10	0.53	0.82	1.23	1.56
Vin=24V	0.02	0.17	0.65	0.99	1.36	1.75

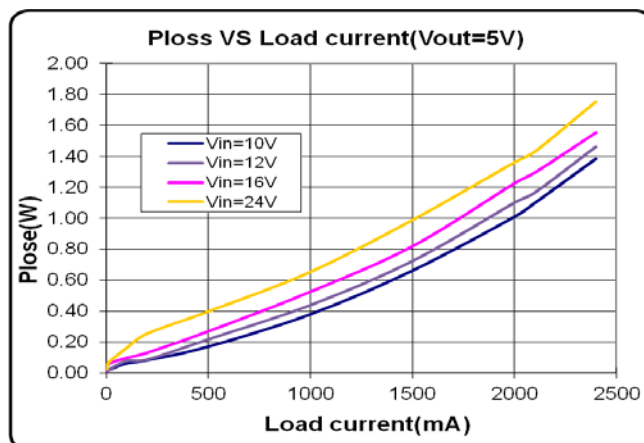

Vin	Vout=9V Power loss (W)					
	Io=0mA	Io=100mA	Io=1000mA	Io=1500mA	Io=2000mA	Io=2400mA
Vin=10V	0.05	0.05	0.24	0.46	0.73	1.08
Vin=12V	0.02	0.06	0.32	0.56	0.89	1.2
Vin=16V	0.03	0.10	0.50	0.80	1.21	1.54
Vin=24V	0.02	0.11	0.72	1.07	1.47	1.85

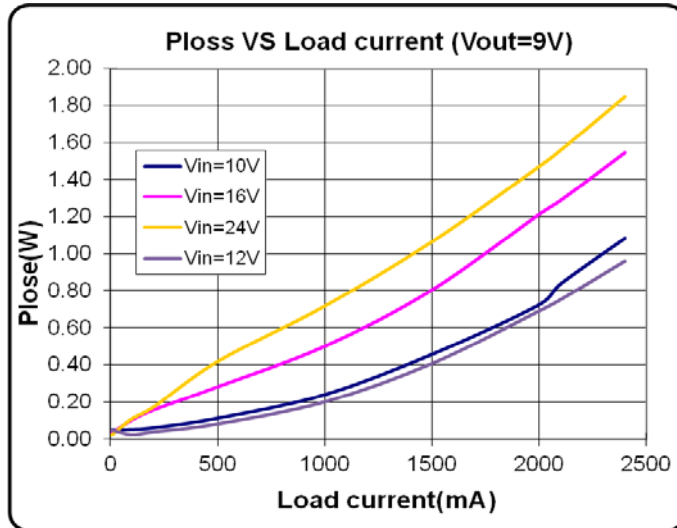

Vin	Vout=12V Power loss (W)					
	Io=0mA	Io=100mA	Io=1000mA	Io=1500mA	Io=2000mA	Io=2400mA
Vin=12V	0.04	0.03	0.20	0.41	0.69	0.96
Vin=16V	0.05	0.09	0.42	0.70	1.03	1.36
Vin=24V	0.05	0.12	0.74	1.07	1.49	1.92

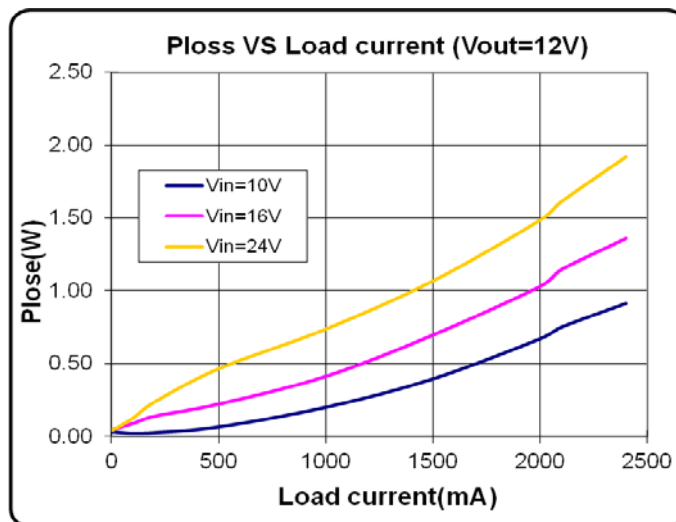



5.4. Constant Current and Constant Voltage (Ta=25°C)

Vout=5V	Vin=12V		Vin=16V		Vin=24V	
	Vout (V)	Iout (mA)	Vout (V)	Iout (mA)	Vout (V)	Iout (mA)
CC Load	5.09	0	5.09	0	5.09	0
	5.12	500	5.12	100	5.12	100
	5.14	1000	5.14	1000	5.14	1000
	5.17	2000	5.17	2000	5.17	2000
	5.22	2400	5.22	2400	5.22	2400
CV Load	4.95	2537	4.85	2536	4.85	2533
	4.8	2537	4.75	2536	4.75	2533
	4.5	2537	4.5	2536	4.5	2533
	4	2537	4	2536	4	2533
	3.5	2537	3.5	2537	3.5	2533
	3	2538	3	2537	3	2533
	2.8	2538	2.5	2537	2.5	2533
	2.6	2212	2.4	2240	2.4	2340
	2.5	0	2.5	0	2.5	0

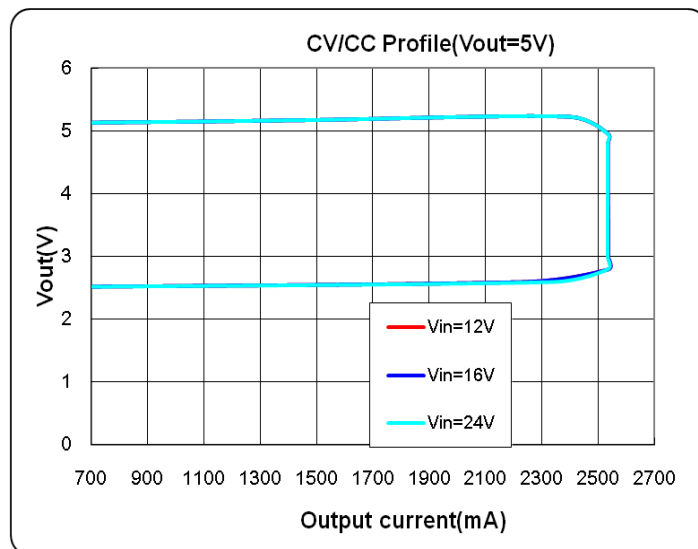

Vout=9V	Vin=12V		Vin=16V		Vin=24V	
	Vout (V)	Iout (mA)	Vout (V)	Iout (mA)	Vout (V)	Iout (mA)
<b>CC Load</b>	9.21	0	9.21	0	9.21	0
	9.24	500	9.24	500	9.24	500
	9.27	1000	9.27	1000	9.27	1000
	9.3	2000	9.3	2000	9.3	2000
	9.34	2400	9.34	2400	9.34	2400
<b>CV Load</b>	9	2542	9	2535	9	2529
	8	2543	8	2535	8	2529
	7	2543	7	2535	7	2529
	6	2544	6	2535	6	2555
	5	2544	5	2535	5	2548
	4	2544	4	2547	4	2610
	3	2543	3	2535	3	2525
	2.5	0	2.5	0	2.5	0

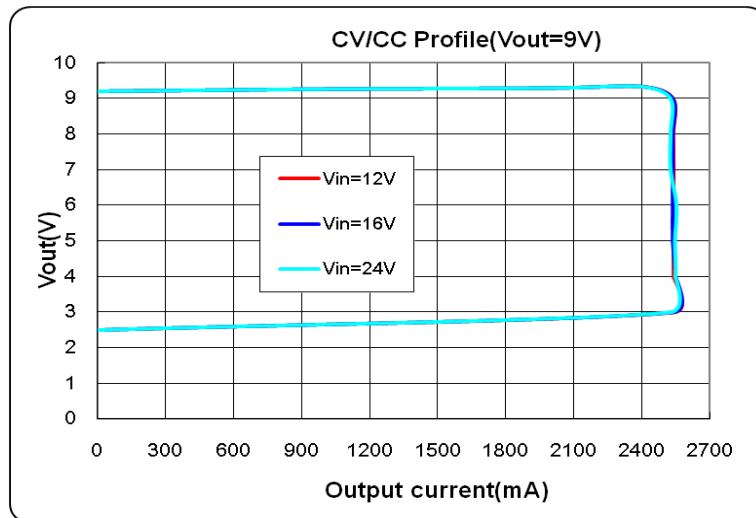

Vout=12V	Vin=12V		Vin=16V		Vin=24V	
	Vout (V)	Iout (mA)	Vout (V)	Iout (mA)	Vout (V)	Iout (mA)
<b>CC Load</b>	12.19	0	12.19	0	12.19	0
	12.22	500	12.22	500	12.22	500
	12.24	1000	12.24	1000	12.24	1000
	12.3	1500	12.3	1500	12.3	1500
	12.32	2400	12.32	2400	12.32	2400
<b>CV Load</b>	11	2538	11.5	2533	12	2530
	10	2538	10	2533	10	2530
	9	2539	9	2534	9	2530
	8	2539	8	2534	8	2530
	7	2540	7	2534	7	2545
	6	2541	6	2535	6	2545
	5	2540	5	2557	5	2540
	4	2541	4	2625	4	2642
	3	2540	3	2530	3	2521
2.5	0	2.5	0	2.5	0	

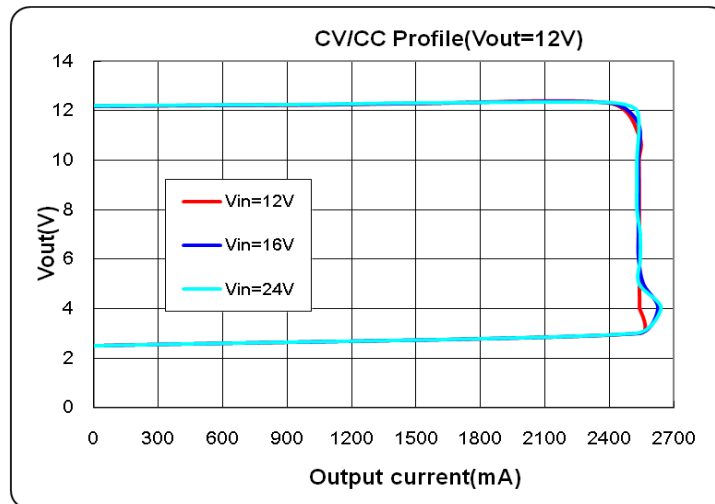

## 5.5. Standby Input Current

Vout=5V

Test Conditions	Input Current (mA)	Power Loss at No Load (mW)
Vin=10V	0.49	4.9
Vin=12V	0.47	5.6
Vin=16V	0.48	7.7
Vin=24V	0.46	11

Vout=9V

Test Conditions	Input Current (mA)	Power Loss at No Load (mW)
Vin=10V	0.74	7.4
Vin=12V	0.55	6.6
Vin=16V	0.53	8.5
Vin=24V	0.53	12.7

Vout=12V

Test Conditions	Input Current (mA)	Power Loss at No Load (mW)
Vin=12V	0.9	10.8
Vin=16V	0.58	9.3
Vin=24V	0.55	13.2

5.6. Ripple and Noise

CH1:Vsw, CH2:Vout2

Vin=10V Vout=5V Iout=0A

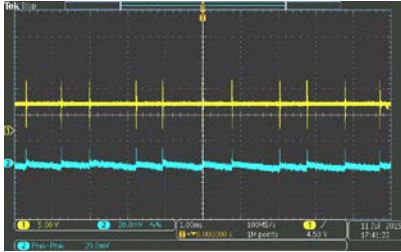

Vin=10V Vout=5V Iout=1A

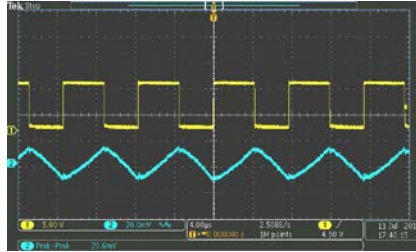

Vin=10V Vout=5V Iout=2.4A

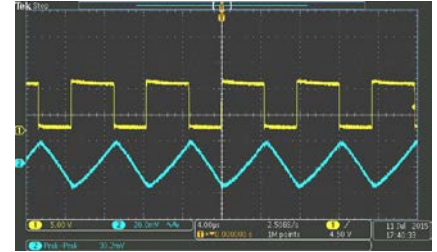

Vin=24V Vout=5V Iout=0A

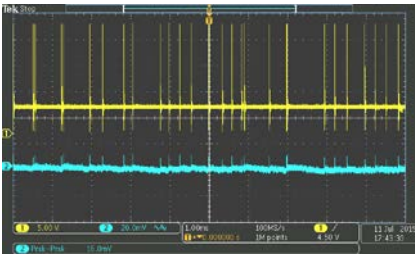

Vin=24V Vout=5V Iout=1A

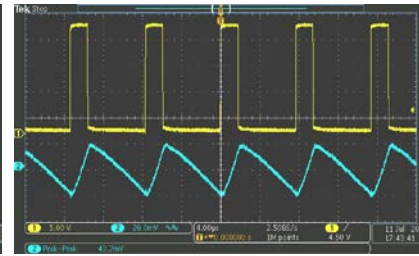

Vin=24V Vout=5V Iout=2.4A

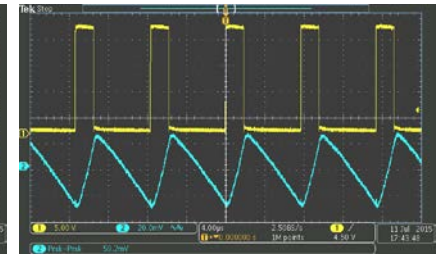

Vin=10V Vout=9V Iout=0A

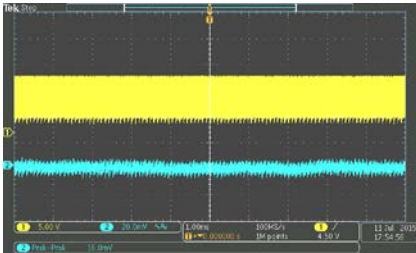

Vin=10V Vout=9V Iout=1A

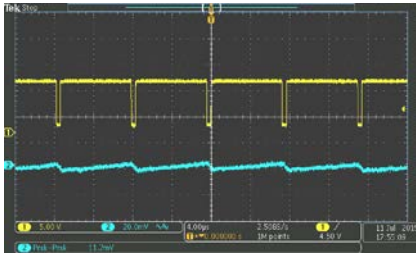

Vin=10V Vout=9V Iout=2.4A

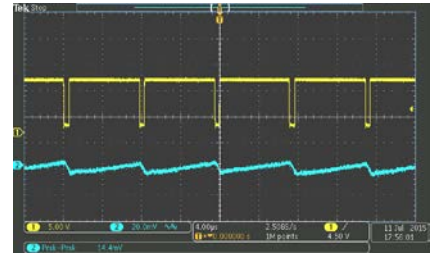

Vin=24V Vout=9V Iout=0A

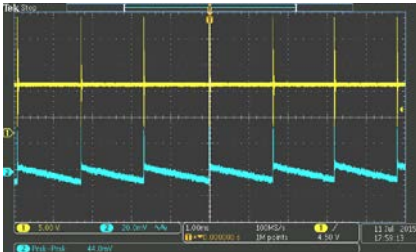

Vin=24V Vout=9V Iout=1A

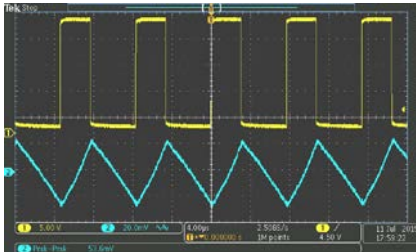

Vin=24V Vout=9V Iout=2.4A

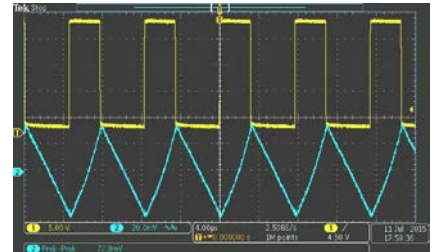

Vin=12V Vout=12V Iout=0A

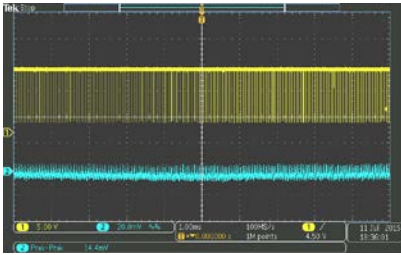

Vin=12V Vout=12V Iout=1A

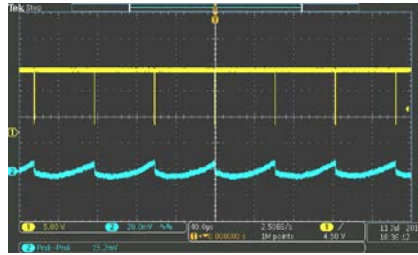

Vin=12V Vout=12V Iout=2.4A

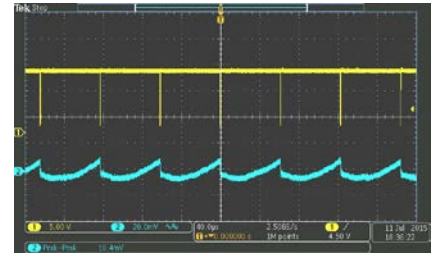

Vin=24V Vout=12V Iout=0A

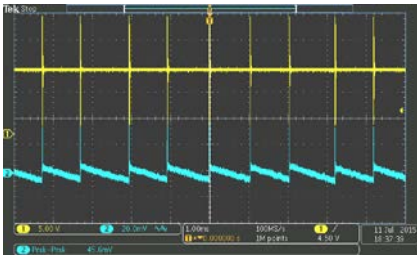

Vin=24V Vout=12V Iout=1A

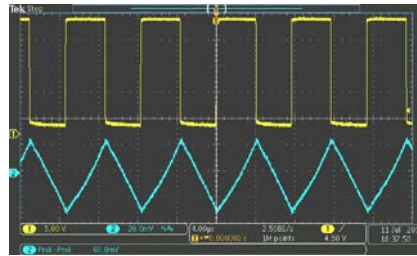

Vin=24V Vout=12V Iout=2.4A

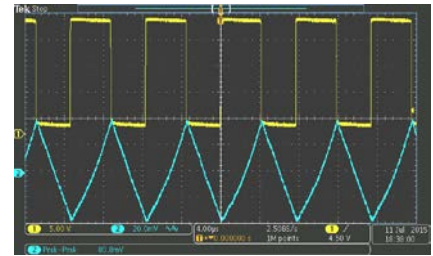

Ripple & noise are measured by using 20MHz bandwidth limited oscilloscope

Test Conditions	Vout=5V			Vout=9V			Vout=12V		
	Iout=0A	Iout=1A	Iout=2.4A	Iout=0A	Iout=1A	Iout=2.4A	Iout=0A	Iout=1A	Iout=2.4A
Vin=10V	20	30	39	16	11	14	13	14	17
Vin=12V	25	34	46	15	21	27	11	15	18
Vin=16V	34	38	52	22	38	51	21	30	38
Vin=24V	36	43	59	44	54	73	46	60	80

### 5.7. Load Dynamic Response

CH2:Vout ripple, CH4:Iout

Vout=5V

Vin=24V, load step 0A-0.5A-0A

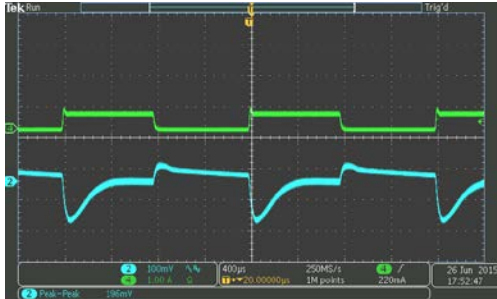

Vin=24V, load step 0.5A-1A-0.5A

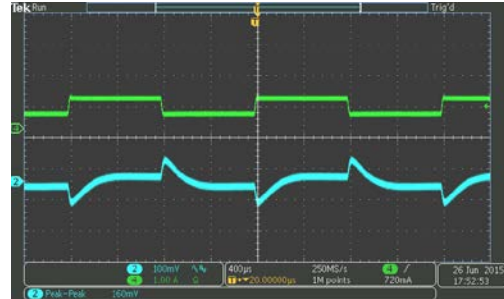

Vin=24V, load step 1A-1.5A-1A

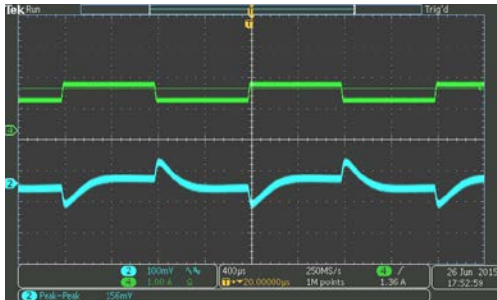

Vin=24V, load step 1.5A-2.4A-1.5A

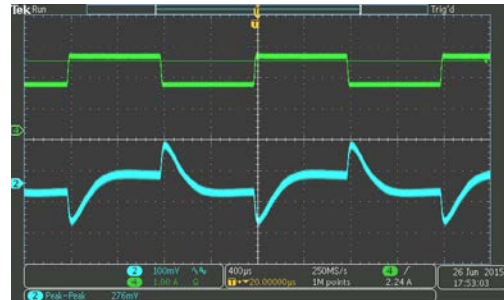

Vout=9V

Vin=24V, load step 0A-0.5A-0A

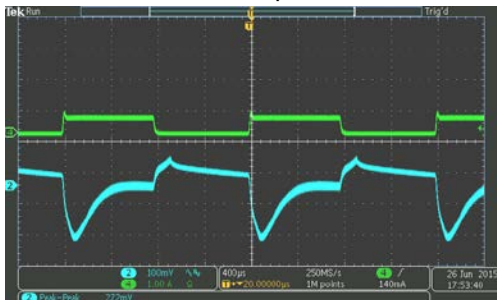

Vin=24V, load step 0.5A-1A-0.5A

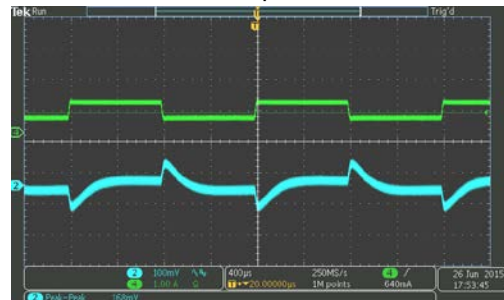

Vin=24V, load step 1A-1.5A-1A

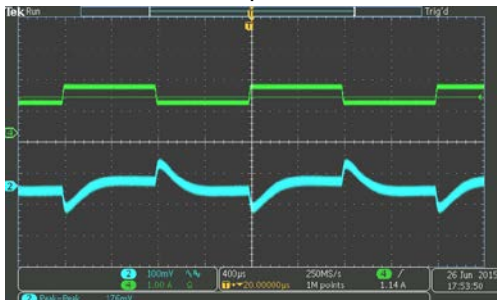

Vin=24V, load step 1.5A-2.4A-1.5A

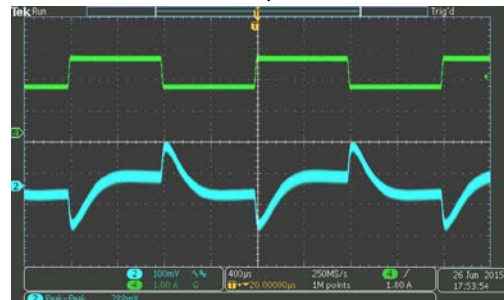

Vout=12V

Vin=24V, load step 0A-0.5A -0A

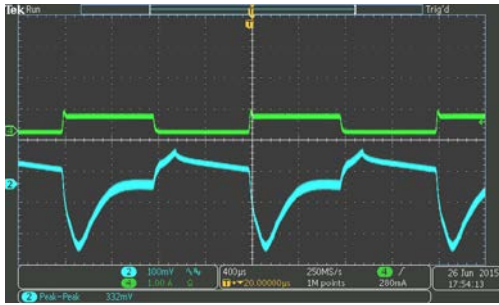

Vin=24V, load step 0.5A-1A-0.5A

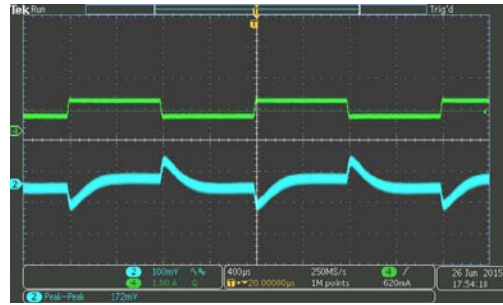

Vin=24V, load step 1A-1.5A-1A

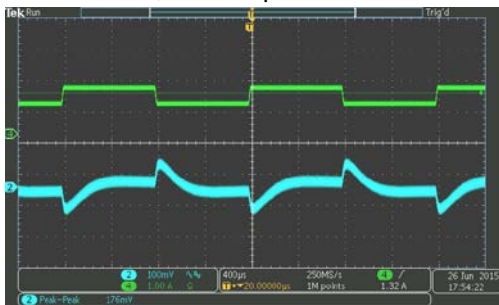

Vin=24V, load step 1.5A-2.4A-1.5A

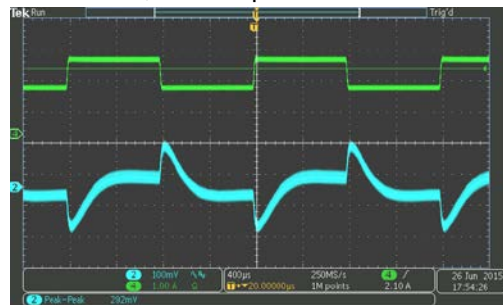

### 5.8. Output Voltage Transient

CH2:Vout,CH3:Vsw,CH4:IL

Vin=12V,lout=0A,Vout 5V—>9V

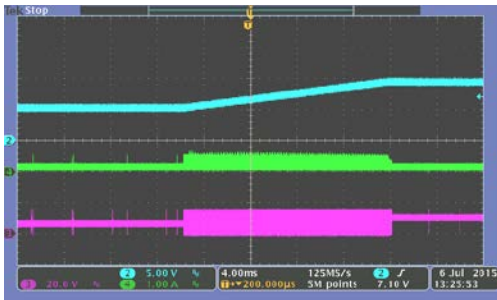

Vin=12V,lout=0A,Vout 9V—>5V

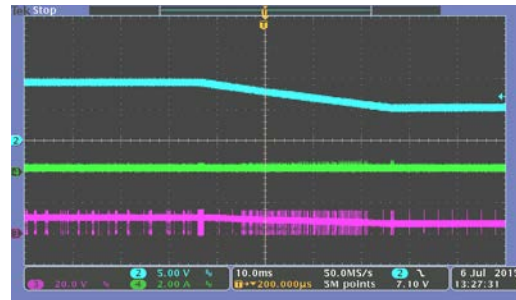

Vin=12V,lout=0A,Vout 9V—>12V

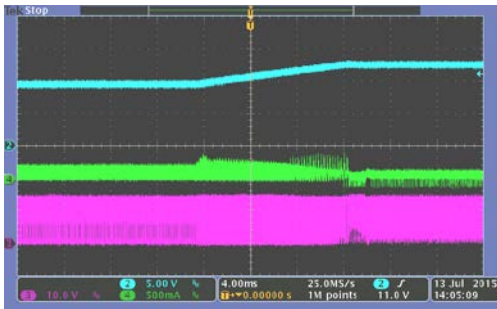

Vin=12V,lout=0A,Vout 12V—>5V

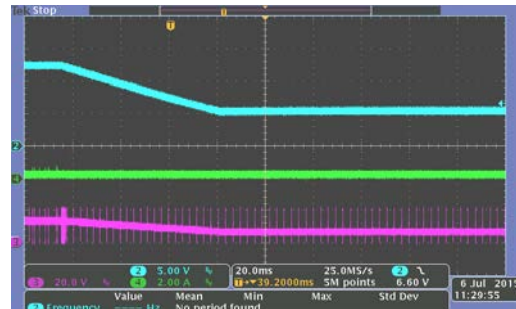



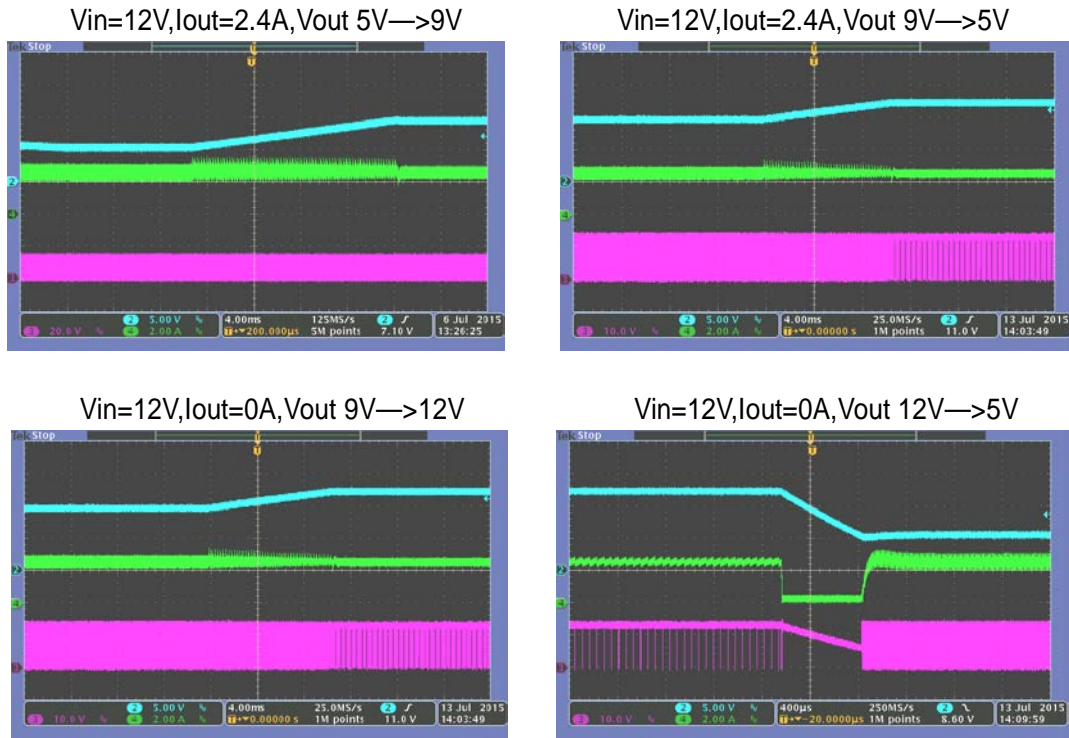

5.9. Line Dynamic Response (Vin change from 12V to 40V, 0.1V/us)

CH1: Vin, CH2: Vout ripple, output 5V/2.4A

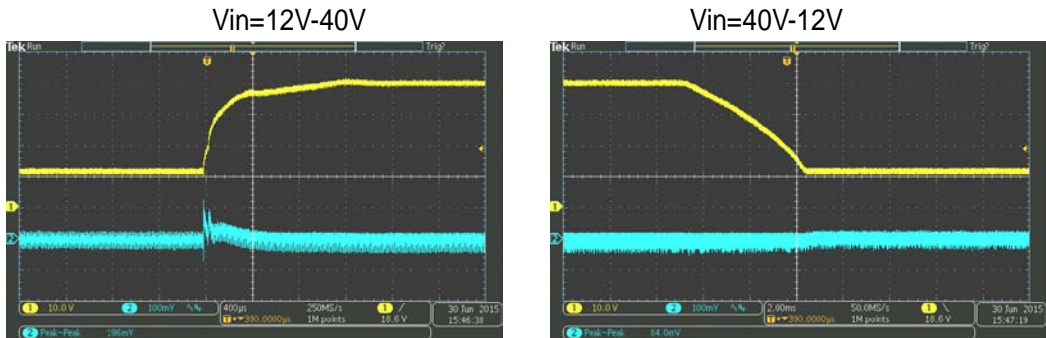

## 5.10.Key Components Temperature Test ( burning for 2 hours)

Vout=5V

Vin/lout	Ambient (°C)	PCB (°C)	IC (°C)	Schottky (°C)	Inductor (°C)
12V/2.4A	33	92	95	97	95
16V/2.4A	33	97	99	104	101
24V/2.4A	33	101	104	109	106

Vout=9V

Vin/lout	Ambient (°C)	PCB (°C)	IC (°C)	Schottky (°C)	Inductor (°C)
12V/2A	33	74	75	73	72
16V/2A	33	84	85	88	83
24V/2A	33	92	93	96	91

Vout=12V

Vin/lout	Ambient (°C)	PCB (°C)	IC (°C)	Schottky (°C)	Inductor (°C)
12V/2A	37	72	75	66	72
16V/2A	38	81	85	78	83
24V/2A	39	92	96	90	95



## 6. EMI TEST

### 6.1. Output=5V

Vin=12V Output 5V2.4A Horizontal

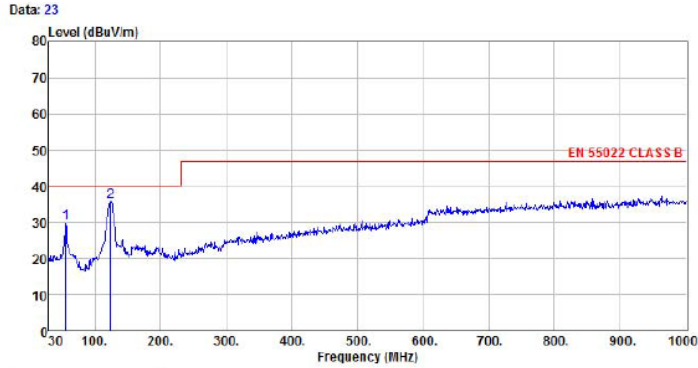

Site : chamber  
 Condition : EN 55022 CLASS B 3m VULB9160 HORIZONTAL  
 EUT :  
 Model Name : 5  
 Temp/Humi : 25°C / 53 %  
 Power Rating: AC 230V/50Hz  
 Mode :  
 Memo :

	Freq	ReadAntenna	Cable	Preamp	Level	Limit	Over	Remark	Factor	
	MHz	Level	Loss	Factor	dB	dBuV/m	dBuV/m	dB	dB/m	
		dBuV	dB/m	dB	dB	dBuV/m	dBuV/m	dB	dB/m	
1	55.22	16.32	12.40	1.00	0.00	29.72	40.00	-10.28	Peak	13.40
2	pp 124.09	21.86	12.27	1.51	0.00	35.64	40.00	-4.36	Peak	13.78

Vin=12V Output 5V2.4A Vertical

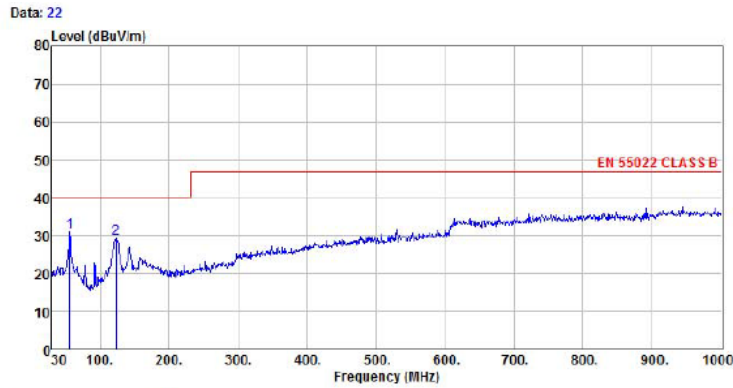

Site : chamber  
 Condition : EN 55022 CLASS B 3m VULB9160 VERTICAL  
 EUT :  
 Model Name : 5  
 Temp/Humi : 25°C / 53 %  
 Power Rating: AC 230V/50Hz  
 Mode :  
 Memo :

	Freq	ReadAntenna	Cable	Preamp	Level	Limit	Over	Remark	Factor	
	MHz	Level	Loss	Factor	dB	dBuV/m	dBuV/m	dB	dB/m	
		dBuV	dB/m	dB	dB	dBuV/m	dBuV/m	dB	dB/m	
1	pp 55.22	17.71	12.40	1.00	0.00	31.11	40.00	-8.89	Peak	13.40
2	123.12	15.33	12.27	1.50	0.00	29.10	40.00	-10.90	Peak	13.77

6.2. Output=9V

Vin=12V Output 9V2.4A Horizontal

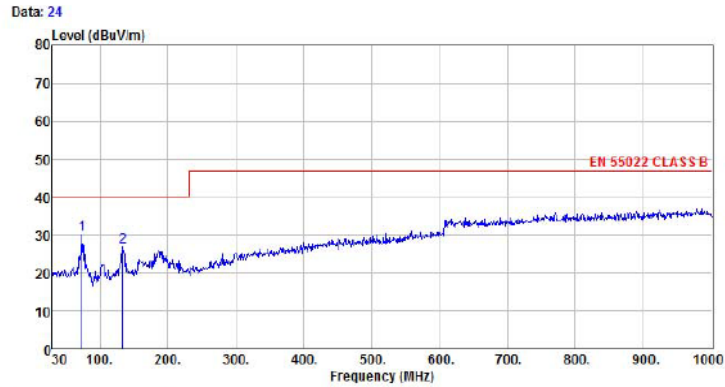

Site : chamber  
 Condition : EN 55022 CLASS B 3m VULB9160 HORIZONTAL  
 EUT :  
 Model Name : 7  
 Temp/Humi : 25°C / 53 %  
 Power Rating: AC 230V/50Hz  
 Mode :  
 Memo :

	Freq	ReadAntenna Level	Antenna Factor	Cable Loss	Preamp Loss	Limit Level	Over Limit	Remark	Factor	
	MHz	dBuV	dB/m	dB	dB	dBuV/m	dBuV/m	dB	dB/m	
1	pp	73.65	19.13	9.87	1.12	0.00	30.12	40.00	-9.88 Peak	10.99
2		133.79	12.29	12.92	1.61	0.00	26.82	40.00	-13.18 Peak	14.53

Vin=12V Output 9V2.4A Vertical

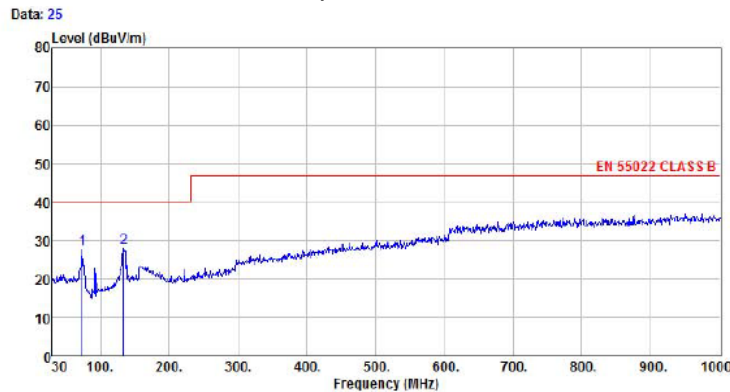

Site : chamber  
 Condition : EN 55022 CLASS B 3m VULB9160 VERTICAL  
 EUT :  
 Model Name : 7  
 Temp/Humi : 25°C / 53 %  
 Power Rating: AC 230V/50Hz  
 Mode :  
 Memo :

	Freq	ReadAntenna Level	Antenna Factor	Cable Loss	Preamp Loss	Limit Level	Over Limit	Remark	Factor	
	MHz	dBuV	dB/m	dB	dB	dBuV/m	dBuV/m	dB	dB/m	
1		73.65	16.69	9.87	1.12	0.00	27.68	40.00	-12.32 Peak	10.99
2	pp	133.79	13.50	12.92	1.61	0.00	28.03	40.00	-11.97 Peak	14.53