

THIS DOCUMENT IS THE PROPERTY OF  
KEYSTONE ELECTRONICS CORP. AND  
SHALL NOT BE REPRODUCED, DISTRIBUTED  
OR USED AS A BASIS FOR MANUFACTURE  
WITHOUT PRIOR WRITTEN PERMISSION  
FROM KEYSTONE ELECTRONICS CORP.

ACTUAL SIZE

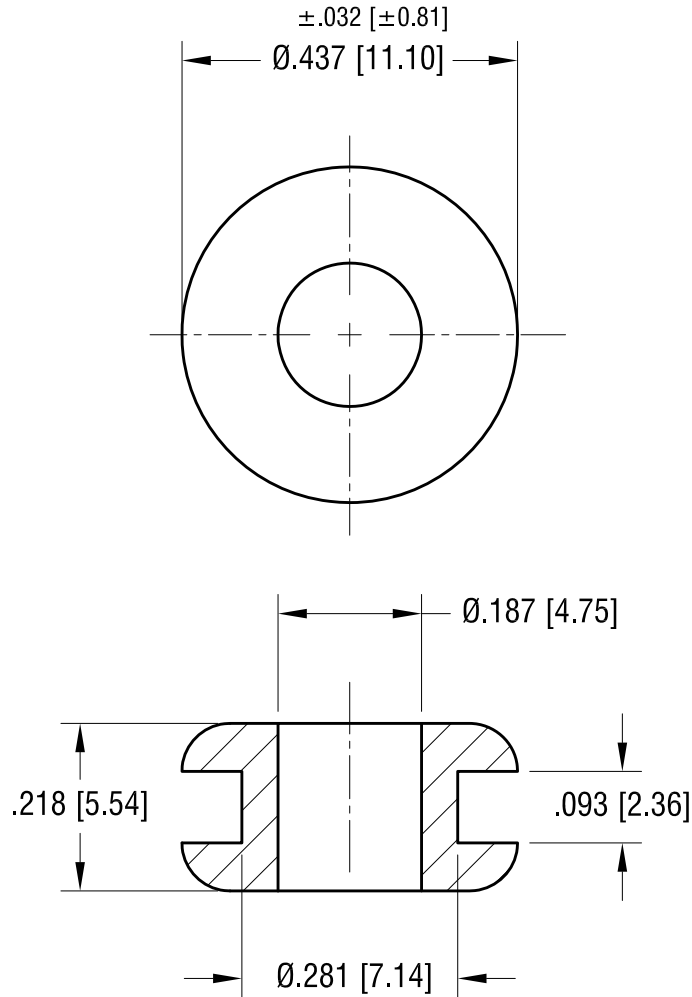

**KEYSTONE ELECTRONICS CORP.**

www.keyelco.com • NEW HYDE PARK, NY 11040 • Tel (516) 328-7500

PART NAME		RUBBER GROMMET	
MATERIAL		BUNA N	
FINISH	NONE	DRN BY	BOONE
		APP'D	RH
		DATE	9.16.96
		SCALE	4X
TOLERANCES	INCH [MM]	CODE	DWG NO.
DECIMAL	$\pm .020$ [ $\pm 0.50$ ]	C	737
ANGULAR	$\pm 1^\circ$		
UNLESS OTHERWISE SPECIFIED			

10.13.21	CHANGE AS PER ECN 21-115	B
1.02.08	CHANGE AS PER ECN 08-011	A
DATE	DESCRIPTION	REV.